



DESCRIPTION

The A7312 is a high efficiency current-mode asynchronous, 24V/1.2A buck converter. Its input voltage ranges from 4V to 24V and it provides an adjustable regulated output voltage from 0.81V to 5.5V while delivering up to 1.2A of output current.

The switching frequency is set to 1.4MHz, which works with a inductor as small as 4.7uH. And the A7312 will automatically switch between PFM and PWM mode based on the load current, thus to enhance the converter efficiency at light load.

A7312 consists of many protection blocks such as UVLO, input voltage over voltage protection to stand much higher input voltage spike, thermal protection and output short circuit protection.

The A7312 is available in SOT-26 package.

ORDERING INFORMATION

Package Type	Part Number	
SOT-26	E6	A7312E6R
		A7312E6VR
Note	V: Halogen free Package R: Tape & Reel	
AiT provides all RoHS products Suffix " V " means Halogen free Package		

FEATURES

- Adjustable Output Voltage, $V_{FB}=0.81V$
- Output current is up to 1.2A
- Range of operation input voltage: 4~24V
- Input voltage UVLO: 3.7V (voltage decreasing)
- Input Overvoltage Protection @26V
- Withstand input voltage spike >30V
- Operating current at zero load: 0.8mA (typ.)
- Line regulation: 0.1%/V (typ.)
- Load regulation: 10mV (typ.)
- High efficiency, up to 90%
- Environment Temperature: -20°C ~85°C
- Available in SOT-26 Package

APPLICATION

- Security Camera
- Consumer Electronic Device for automobile
- Portable DVD
- ADSL Modem, WLAN router
- Other 12V or double cell Li-ion battery powered device

TYPICAL APPLICATION

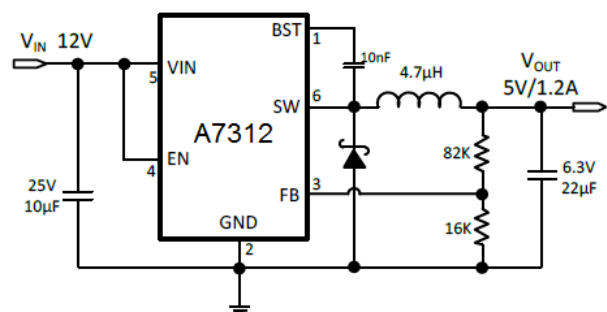



PIN DESCRIPTION

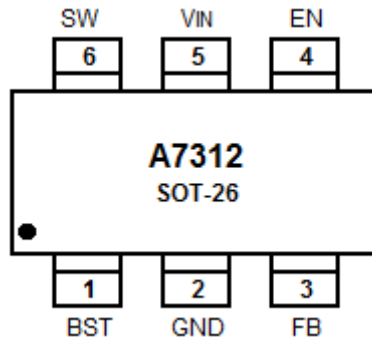

Top View

Pin #	Symbol	Function
1	BST	High side power transistor gate drive boost input
2	GND	Ground.
3	FB	Feedback input with reference voltage set to 0.81V
4	EN	Enable input. Setting it to high level or connecting to V_{IN} via a resistor may turn on the chip, while setting it to ground level will turn off the chip.
5	V_{IN}	Power input, the input capacitor should be placed as close to V_{IN} and GND pin as possible
6	SW	Power switching node to connect inductor



ABSOLUTE MAXIMUM RATINGS

Max Input Voltage	30V	
T _J , Max Operating Junction Temperature	125°C	
T _A , Ambient Temperature	-20°C ~ 85°C	
Package Thermal Resistance	SOT-26 (θ_{JC})	110°C / W
	SOT-26 (θ_{JA})	220°C / W
T _S , Storage Temperature	-40°C ~ 150°C	
Lead Temperature & Time	260°C, 10S	
HBM, ESD	>2KV	

Stress beyond above listed "Absolute Maximum Ratings" may lead permanent damage to the device. These are stress ratings only and operations of the device at these or any other conditions beyond those indicated in the operational sections of the specifications are not implied. Exposure to absolute maximum rating conditions for extended periods may affect device reliability.

RECOMMENDED OPERATING CONDITIONS

Parameter	Symbol	MIN	MAX	Units
Input Voltage Range		4	24	V
Output Voltage Range		0.81	5.5	V
Operating Junction Temperature	T _J	-20	125	°C



ELECTRICAL CHARACTERISTICS

$V_{IN}=12V$, $T_A=25^{\circ}C$

Parameter	Symbol	Conditions	Min.	Typ.	Max.	Unit
Input Voltage Range	V_{DD}		4		24	V
Output Voltage Range	V_{OUT}		0.81		5.5	V
Feedback Voltage	V_{ref}	$V_{IN}=12V$, $V_{EN}=5V$	0.79	0.81	0.83	V
UVLO Voltage	V_{UVLO}	V_{IN} H \rightarrow L, $I_{OUT}=0.5A$		3.7		V
Feedback Leakage Current	I_{fb}			0.1	0.4	μA
Quiescent Current	I_Q	Active, $V_{FB}=1V$, No Switching		0.6	1.0	mA
		Shutdown, $V_{IN}=8V$		6	10	μA
Line Regulation	$LnReg$	$V_{IN}=5V$ to 12V		0.1		%/V
Load Regulation	$LdReg$	$I_{OUT}=0.1$ to 1.2A		0.02		%/A
Switching Frequency	F_{SOC}	$V_{EN}=3V$, $V_{IN}=12V$	1.0	1.4	1.8	MHz
High side Switch $R_{DS(on)}$	$R_{DS(on)_H}$	$I_{SW}=200mA$		250	350	mohm
Peak Inductor Current Limit	I_{LIMIT}	$V_{IN}=12V$, $V_{OUT}=5V$	1.5	2		A
EN High Threshold	V_{EN_H}		1	1.5	3	V
EN Low Threshold	V_{EN_L}				0.5	V
Input Over-Voltage Protection	V_{OVP}	$V_{EN}=3V$		26		V
Over Temperature Protection	TSD	Hysteresis= $40^{\circ}C$		150		$^{\circ}C$



TYPICAL PERFORMANCE CHARACTERISTICS

$V_{IN}=12V$, $V_{OUT}=5.0V$, $L=4.7\mu H$, $C_{IN}=10\mu F$, $C_{OUT}=22\mu F$, $T_A=25^\circ C$, unless otherwise stated

1. Efficiency vs I_{OUT} , $V_{OUT}=5.0V$

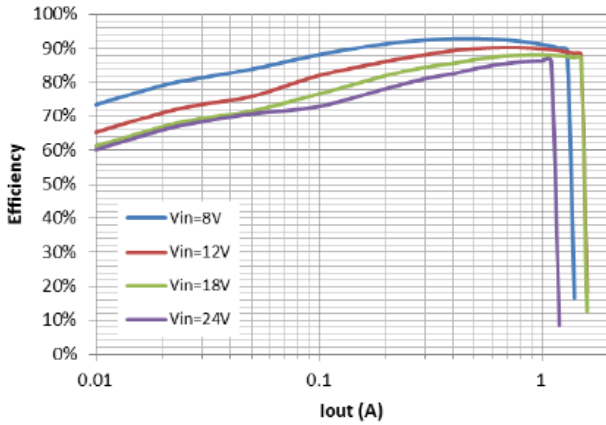

2. Line Regulation, $V_{OUT}=5.0V$

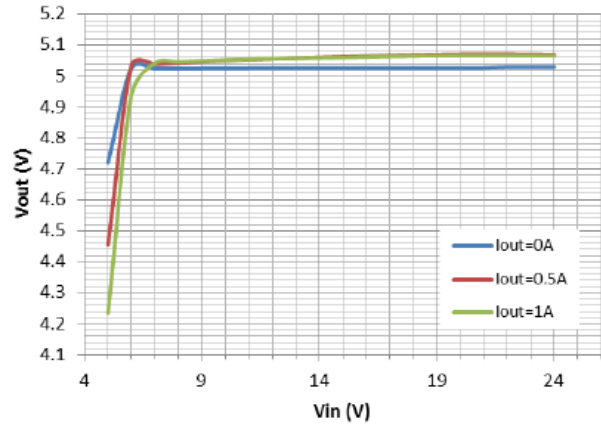

3. Load Regulation, $V_{OUT}=5.0V$

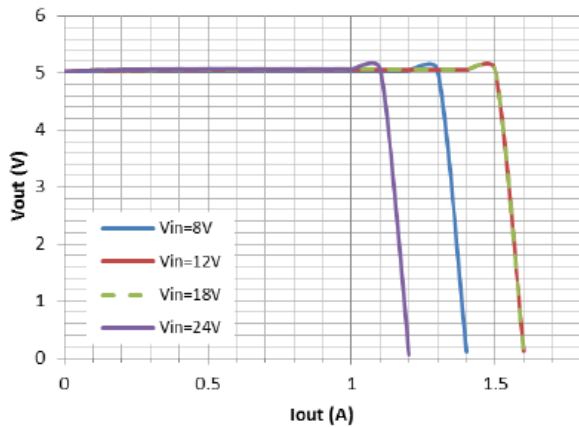

4. Input Current at Zero Load, $I_{OUT}=0mA$

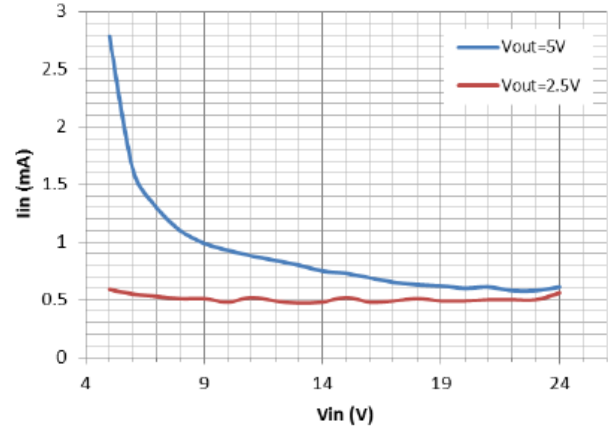

5. Switching Waveform, $V_{IN}=12V$, $I_{OUT}=0.5A$

CH1= V_{IN} , CH2= V_{OUT} , CH3=SW, CH4= I_{SW}

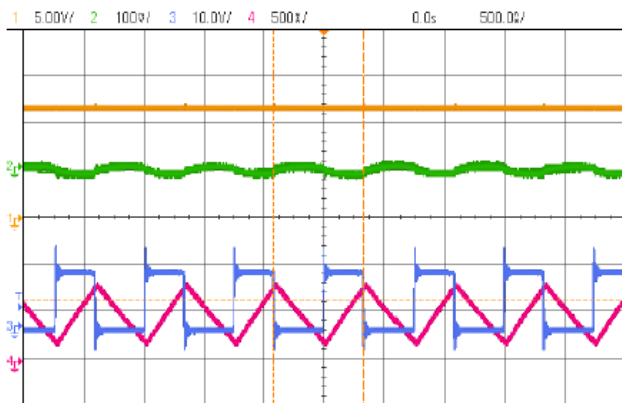

6. Switching Waveform, $V_{IN}=12V$, $I_{OUT}=1A$

CH1= V_{IN} , CH2= V_{OUT} , CH3=SW, CH4= I_{SW}

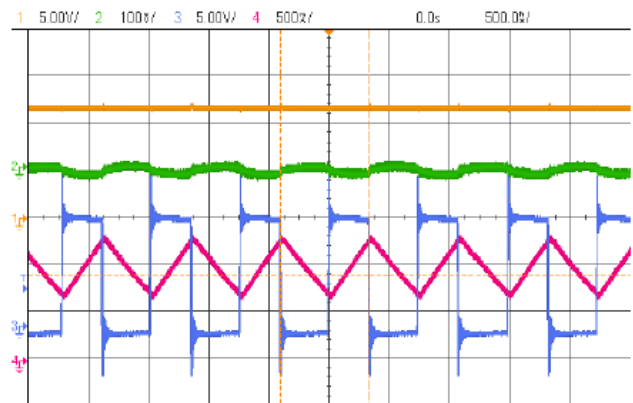



7. Switching Waveform, $V_{IN}=24V$, $I_{OUT}=0.5A$
CH1= V_{IN} , CH2= V_{OUT} , CH3=SW, CH4= I_{SW}

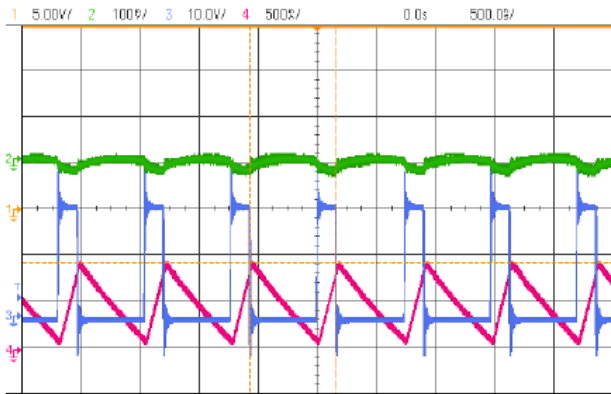

8. Switching Waveform, $V_{IN}=24V$, $I_{OUT}=1A$
CH1= V_{IN} , CH2= V_{OUT} , CH3=SW, CH4= I_{SW}

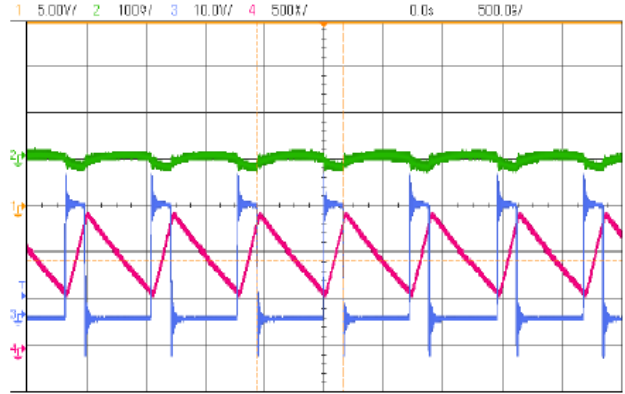

9. Load Transient Response, $V_{IN}=12V$, $I_{OUT}=0.12\sim 1A$
CH1= V_{IN} , CH2= V_{OUT} , CH4= I_{SW}

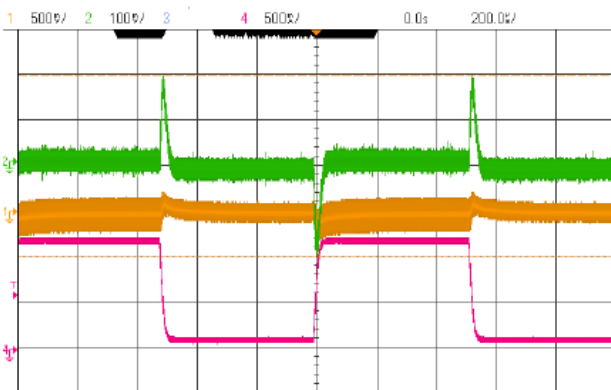

10. Load Transient Response, $V_{IN}=24V$, $I_{OUT}=0.12\sim 1A$
CH1= V_{IN} , CH2= V_{OUT} , CH4= I_{SW}

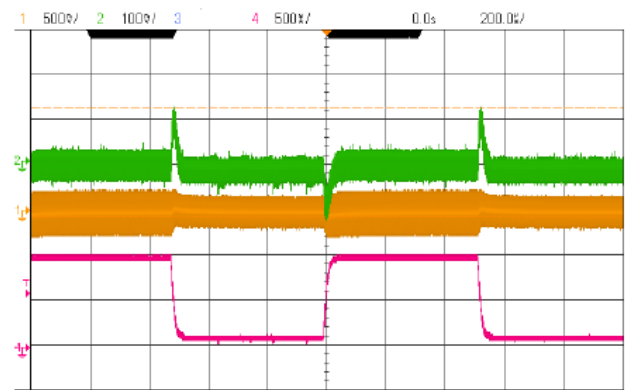

11. Input Current at Zero Load

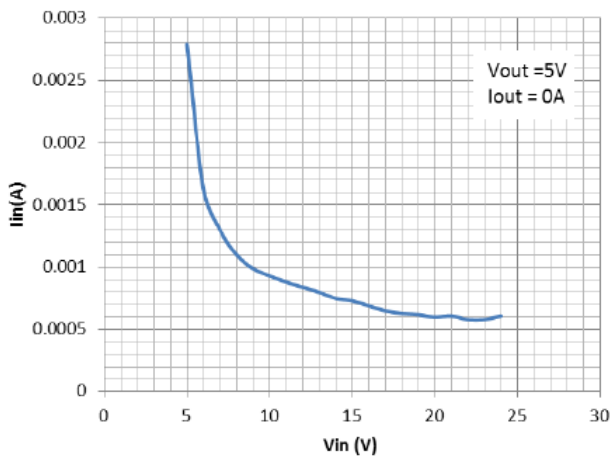



BLOCK DIAGRAM

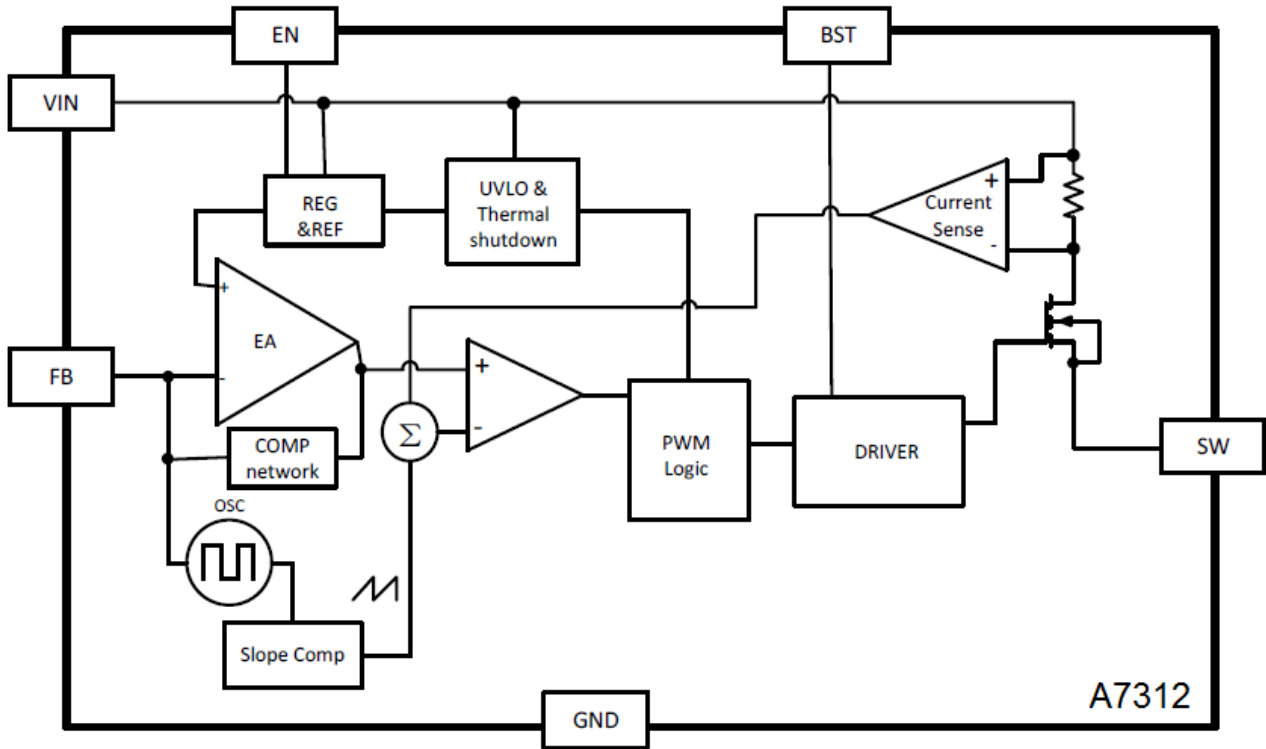



DETAILED INFORMATION

Functional Description

Loop Operation

The A7312 is a wide input range, high-efficiency, DC-to-DC step-down switching regulator, capable of delivering up to 1.2A of output current, integrated with a 250mΩ MOSFET, with external schottky diode. It uses a PWM current-mode control scheme. An error amplifier integrates error between the FB signal and the internal reference voltage. The output of the integrator is then compared to the sum of a current-sense signal and the slope compensation ramp. This operation generates a PWM signal that modulates the duty cycle of the power MOSFETs to achieve regulation for output voltage.

Current Limit

There is a cycle-by-cycle current limit on the high-side MOSFET of 1.5A (typ). When the current flowing out of SW exceeds this limit, the high-side MOSFET turns off and the external schottky diode rectifier turns on. Unlike the traditional method of current limiting by limiting the voltage at the internal compensation node, which usually has large variation due to duty cycle variance, this type of peak current limiting scheme provides a relatively more accurate limit for output current, thereby lowering the requirements for system design.

Light Load Operation

Traditionally, a fixed current mode constant frequency PWM DC-DC regulator always switches even when the output load is small. When energy is shuffling back and forth through the power MOSFETs, power is lost due to the finite RDSOns of the MOSFETs and parasitic capacitances. At light load, this loss is prominent and efficiency is therefore very low. A7312 employs a proprietary control scheme that improves efficiency in this situation by enabling the device into a power save mode during light load, thereby extending the range of high efficiency operation.

Component Selection

When setting up the A7312 for different output voltage, please use following recommended component value for the best performance.

V _{OUT} (V)	C _{OUT} (μF)	L(μH)
5.0	22	6.8~10
3.3	22	4.7~10
2.5	22	3.3~10



Thermal Consideration

A7312 is high efficiency Buck converter, which means it consumes very few power when converting the high voltage to low voltage. However, when output power is very large, like 5V/1.2A, the output power is as high as 6W, a heat dissipation path is strongly recommended to be routed on PCB. A7312 is in SOT-26 package. The heat is conducted out via Pin 2 (GND), so the heat dissipation route on PCB should be connected to the Pin 2 of the chip.



PACKAGE INFORMATION

Dimension in SOT-26 Package (Unit: mm)

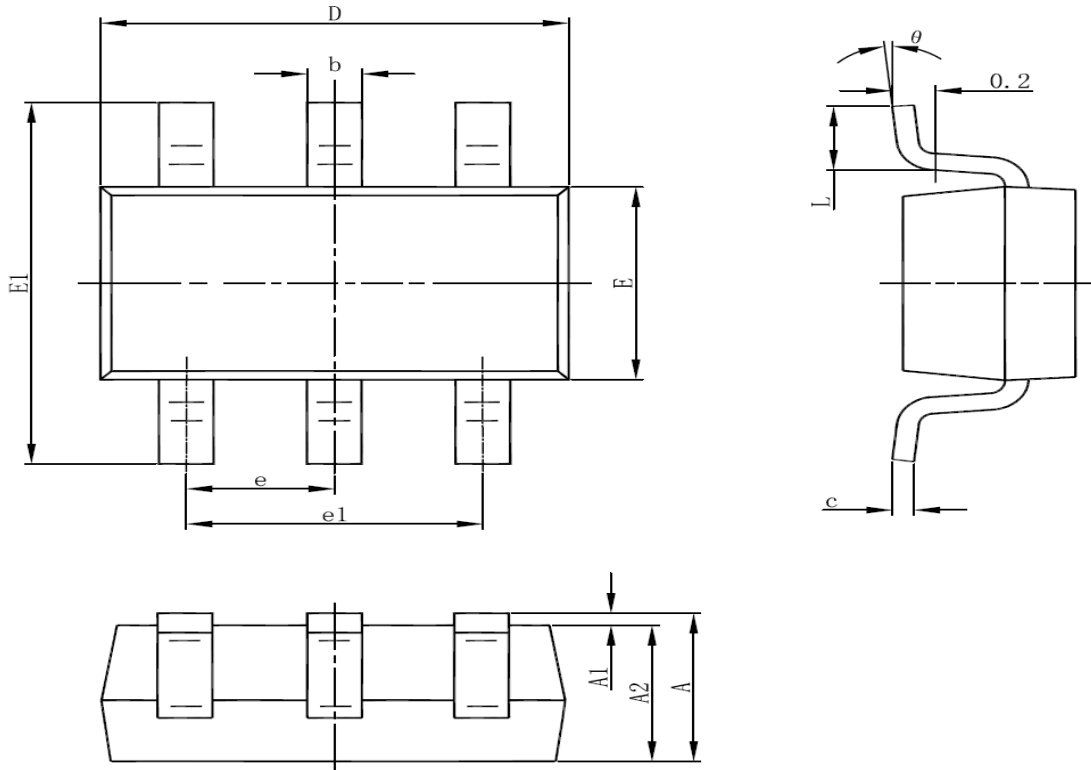

SYMBOL	MIN	MAX
A	1.100	1.400
A1	0.000	0.100
A2	1.000	1.300
b	0.200	0.500
c	0.100	0.250
D	2.700	3.100
E	1.500	1.800
E1	2.500	3.100
e	0.950(BSC)	
e1	1.700	2.100
L	0.200	-
θ	0°	8°



IMPORTANT NOTICE

AiT Semiconductor Inc. (AiT) reserves the right to make changes to any its product, specifications, to discontinue any integrated circuit product or service without notice, and advises its customers to obtain the latest version of relevant information to verify, before placing orders, that the information being relied on is current.

AiT Semiconductor Inc.'s integrated circuit products are not designed, intended, authorized, or warranted to be suitable for use in life support applications, devices or systems or other critical applications. Use of AiT products in such applications is understood to be fully at the risk of the customer. As used herein may involve potential risks of death, personal injury, or severe property, or environmental damage. In order to minimize risks associated with the customer's applications, the customer should provide adequate design and operating safeguards.

AiT Semiconductor Inc. assumes to no liability to customer product design or application support. AiT warrants the performance of its products of the specifications applicable at the time of sale.