



November 2006

# FSQ0365RN, FSQ0265RN, FSQ0165RN, FSQ311 Green Mode Fairchild Power Switch (FPS™) for Quasi-Resonant Operation - Low EMI and High Efficiency

## Features

- Optimized for Quasi-Resonant Converter (QRC)
- Low EMI through Variable Frequency Control and Inherent Frequency Modulation
- High-Efficiency through Minimum Voltage Switching
- Narrow Frequency Variation Range over Wide Load and Input Voltage Variation
- Advanced Burst-Mode Operation for Low Standby Power Consumption
- Pulse-by-Pulse Current Limit
- Various Protection Functions: Overload Protection (OLP), Over-Voltage Protection (OVP), Abnormal Over-Current Protection (AOCP), Internal Thermal Shutdown (TSD)
- Under-Voltage Lockout (UVLO) with Hysteresis
- Internal Start-up Circuit
- Internal High-Voltage Sense FET (650V)
- Built-in Soft-Start (15ms)

## Description

A Quasi-Resonant Converter (QRC) generally shows lower EMI and higher power conversion efficiency than a conventional hard-switched converter with a fixed switching frequency. The FSQ-series is an integrated Pulse-Width Modulation (PWM) controller and SenseFET specifically designed for quasi-resonant operation with minimal external components. The PWM controller includes an integrated fixed-frequency oscillator, Under-Voltage Lockout, Leading Edge Blanking (LEB), optimized gate driver, internal soft-start, temperature-compensated precise current sources for loop compensation, and self-protection circuitry. Compared with discrete MOSFET and PWM controller solution, the FSQ-series can reduce total cost, component count, size and weight; while simultaneously increasing efficiency, productivity, and system reliability. This device provides a basic platform that is well suited for cost-effective designs of quasi-resonant switching fly-back converters.

## Applications

- Power Supply for DVP Player and DVD Recorder
- Power supply for Set-Top Box
- Adapter
- Auxiliary Power Supply for PC, LCD TV, and PDP TV

## Ordering Information

Product Number <sup>(5)</sup>	PKG.	Operating Temp.	Current Limit	R <sub>DS(ON)</sub> Max.	Maximum Output Power <sup>(1)</sup>				Replaces Devices
					230V <sub>AC</sub> ±15% <sup>(2)</sup>		85-265V <sub>AC</sub>		
					Adapter <sup>(3)</sup>	Open Frame <sup>(4)</sup>	Adapter <sup>(3)</sup>	Open Frame <sup>(4)</sup>	
FSQ311	8-DIP	-25 to +85°C	0.6A	19Ω	7W	10W	6W	8W	FSDL321 FSDM311
FSQ0165RN	8-DIP	-25 to +85°C	0.9A	10Ω	10W	15W	9W	13W	FSDL0165RN
FSQ0265RN	8-DIP	-25 to +85°C	1.2A	6Ω	14W	20W	11W	16W	FSDM0265RN FSDM0265RNB
FSQ0365RN	8-DIP	-25 to +85°C	1.5A	4.5Ω	17.5W	25W	13W	19W	FSDM0365RN RSDM0365RNB

### Notes:

1. The junction temperature can limit the maximum output power.
2. 230VAC or 100/115VAC with doubler. The maximum power with CCM operation.
3. Typical continuous power in a non-ventilated enclosed adapter measured at 50°C ambient temperature.
4. Maximum practical continuous power in an open frame design at 50°C ambient.
5. PB-free package per JEDEC J-STD-020B.

FPS™ is a trademark of Fairchild Semiconductor Corporation.



## Pin Configuration

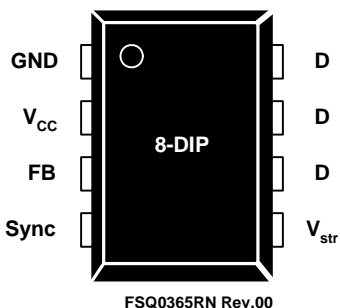

Figure 3. Pin Configuration (Top View)

## Pin Definitions

Pin #	Name	Description
1	GND	<b>Ground.</b> This pin is the control ground and the SenseFET source.
2	V <sub>CC</sub>	<b>Power Supply.</b> This pin is the positive supply input. This pin provides internal operating current for both start-up and steady-state operation.
3	FB	<b>Feedback.</b> This pin is internally connected to the inverting input of the PWM comparator. The collector of an opto-coupler is typically tied to this pin. For stable operation, a capacitor should be placed between this pin and GND. If the voltage of this pin reaches 6V, the overload protection triggers, which shuts down the FPS.
4	Sync	<b>Sync.</b> This pin is internally connected to the sync-detect comparator for quasi-resonant switching. In normal quasi-resonant operation, the threshold of the sync comparator is 0.7V/0.2V.
5	V <sub>str</sub>	<b>Start-up.</b> This pin is connected directly to the high-voltage DC link. At start-up, the internal high-voltage current source supplies internal bias and charges the external capacitor connected to the V <sub>CC</sub> pin. Once V <sub>CC</sub> reaches 12V, the internal current source is disabled.
6	Drain	<b>SenseFET drain.</b> High-voltage power SenseFET drain connection.
7	Drain	<b>SenseFET drain.</b> High-voltage power SenseFET drain connection.
8	Drain	<b>SenseFET drain.</b> High-voltage power SenseFET drain connection.

## Absolute Maximum Ratings

The “Absolute Maximum Ratings” are those values beyond which the safety of the device cannot be guaranteed. The device should not be operated at these limits. The parametric values defined in the Electrical Characteristics tables are not guaranteed at the absolute maximum ratings.  $T_A = 25^\circ\text{C}$ , unless otherwise specified.

Symbol	Parameter		Min.	Max.	Unit
$V_{str}$	$V_{str}$ Pin Voltage		500		V
$V_{DS}$	Drain Pin Voltage		650		V
$V_{CC}$	Supply Voltage			20	V
$V_{FB}$	Feedback Voltage Range		-0.3	9.0	V
$V_{Sync}$	Sync Pin Voltage		-0.3	9.0	V
$I_{DM}$	Drain Current Pulsed <sup>(6)</sup>	FSQ0365RN		12	A
		FSQ0265RN		8	
		FSQ0165RN		4	
		FSQ311		1.5	
$E_{AS}$	Single Pulsed Avalanche Energy <sup>(7)</sup>	FSQ0365RN		230	mJ
		FSQ0265RN		140	
		FSQ0165RN		50	
		FSQ311		10	
$P_D$	Total Power Dissipation			1.5	W
$T_J$	Operating Junction Temperature		Internally limited		$^\circ\text{C}$
$T_A$	Operating Ambient Temperature		-25	85	$^\circ\text{C}$
$T_{STG}$	Storage Temperature		-55	150	$^\circ\text{C}$
	ESD Capability, HBM Model <sup>(8)</sup>		CLASS1 C		
	ESD Capability, Machine Model <sup>(8)</sup>		CLASS B		

### Notes:

6. Repetitive rating: Pulse width limited by maximum junction temperature.
7.  $L=14\text{mH}$ , starting  $T_J=25^\circ\text{C}$ .
8. Meets JEDEC Standards JESD 22-A114 and 22-A115.

## Thermal Impedance<sup>(9)</sup>

Symbol	Parameter	Value	Unit
<b>8-DIP</b>			
$\theta_{JA}$ <sup>(10)</sup>	Junction-to-Ambient Thermal Resistance	80	$^\circ\text{C/W}$
$\theta_{JC}$ <sup>(11)</sup>	Junction-to-Case Thermal Resistance	20	
$\theta_{JT}$ <sup>(12)</sup>	Junction-to-Top Thermal Resistance	35	

### Notes:

9. All items are tested with the standards JESD 51-2 and 51-10 (DIP).
10. Free-standing, with no heat-sink, under natural convection.
11. Infinite cooling condition - refer to the SEMI G30-88.
12. Measured on the PKG top surface.

## Electrical Characteristics

T<sub>A</sub> = 25°C unless otherwise specified.

Symbol	Parameter	Condition	Min.	Typ.	Max.	Unit
<b>SENSEFET SECTION</b>						
BV <sub>DSS</sub>	Drain Source Breakdown Voltage	V <sub>CC</sub> = 0V, I <sub>D</sub> = 100μA	650			V
I <sub>DSS</sub>	Zero-Gate-Voltage Drain Current	V <sub>DS</sub> = 560V			100	μA
R <sub>DS(ON)</sub>	Drain-Source on-State Resistance	FSQ0365RN	T <sub>J</sub> = 25°C, I <sub>D</sub> = 0.5A	3.5	4.5	Ω
		FSQ0265RN		5.0	6.0	
		FSQ0165RN		8.0	10.0	
		FSQ311		14.0	19.0	
C <sub>SS</sub>	Input Capacitance	FSQ0365RN	V <sub>GS</sub> = 0V, V <sub>DS</sub> = 25V, f = 1MHz	315		pF
		FSQ0265RN		550		
		FSQ0165RN		250		
		FSQ311		162		
C <sub>OSS</sub>	Output Capacitance	FSQ0365RN	V <sub>GS</sub> = 0V, V <sub>DS</sub> = 25V, f = 1MHz	47		pF
		FSQ0265RN		38		
		FSQ0165RN		25		
		FSQ311		18		
C <sub>RSS</sub>	Reverse Transfer Capacitance	FSQ0365RN	V <sub>GS</sub> = 0V, V <sub>DS</sub> = 25V, f = 1MHz	9.0		pF
		FSQ0265RN		17.0		
		FSQ0165RN		10.0		
		FSQ311		3.8		
t <sub>d(on)</sub>	Turn-On Delay Time	FSQ0365RN	V <sub>DD</sub> = 350V, I <sub>D</sub> = 25mA	11.2		ns
		FSQ0265RN		20.0		
		FSQ0165RN		12.0		
		FSQ311		9.5		
t <sub>r</sub>	Rise Time	FSQ0365RN	V <sub>DD</sub> = 350V, I <sub>D</sub> = 25mA	34		ns
		FSQ0265RN		15		
		FSQ0165RN		4		
		FSQ311		19		
t <sub>d(off)</sub>	Turn-Off Delay Time	FSQ0365RN	V <sub>DD</sub> = 350V, I <sub>D</sub> = 25mA	28.3		ns
		FSQ0265RN		55.0		
		FSQ0165RN		30.0		
		FSQ311		33.0		
t <sub>f</sub>	Fall Time	FSQ0365RN	V <sub>DD</sub> = 350V, I <sub>D</sub> = 25mA	32		ns
		FSQ0265RN		25		
		FSQ0165RN		10		
		FSQ311		42		

## Electrical Characteristics (Continued)

T<sub>A</sub> = 25°C unless otherwise specified.

Symbol	Parameter	Condition	Min.	Typ.	Max.	Unit	
<b>CONTROL SECTION</b>							
t <sub>ON.MAX</sub>	Maximum ON Time	T <sub>J</sub> = 25°C	10.5	12.0	13.5	μsec	
t <sub>B</sub>	Blanking Time		13.2	15.0	16.8	μsec	
t <sub>W</sub>	Detection Time Window	T <sub>J</sub> = 25°C, V <sub>sync</sub> = 0V		3.0		μsec	
f <sub>S</sub>	Initial Switching Frequency		50.5	55.6	61.7	kHz	
Δf <sub>S</sub>	Switching Frequency Variation <sup>(13)</sup>	-25°C < T <sub>J</sub> < 85°C		±5	±10	%	
I <sub>FB</sub>	Feedback Source Current	V <sub>FB</sub> = 0V	700	900	1100	μA	
D <sub>MIN</sub>	Minimum Duty Cycle	V <sub>FB</sub> = 0V			0	%	
V <sub>START</sub>	UVLO Threshold Voltage		11	12	13	V	
V <sub>STOP</sub>		After turn-on	7	8	9	V	
t <sub>S/S</sub>	Internal Soft-Start Time	With free-running frequency		15		ms	
<b>BURST-MODE SECTION</b>							
V <sub>BURH</sub>	Burst-Mode Voltages	T <sub>J</sub> = 25°C, t <sub>PD</sub> = 200ns <sup>(14)</sup>	0.45	0.55	0.65	V	
V <sub>BURL</sub>			0.25	0.35	0.45	V	
Hysteresis				200		mV	
<b>PROTECTION SECTION</b>							
I <sub>LIMIT</sub>	Peak Current Limit	FSQ0365RN	T <sub>J</sub> = 25°C, di/dt = 240mA/μsec	1.32	1.50	1.68	A
		FSQ0265RN	T <sub>J</sub> = 25°C, di/dt = 200mA/μsec	1.06	1.20	1.34	
		FSQ0165RN	T <sub>J</sub> = 25°C, di/dt = 150mA/μsec	0.8	0.9	1.0	
		FSQ311	T <sub>J</sub> = 25°C, di/dt = 100mA/μsec	0.53	0.60	0.67	
V <sub>SD</sub>	Shutdown Feedback Voltage	V <sub>CC</sub> = 15V	5.5	6.0	6.5	V	
I <sub>DELAY</sub>	Shutdown Delay Current	V <sub>FB</sub> = 5V	4	5	6	μA	
t <sub>LEB</sub>	Leading-Edge Blanking Time <sup>(13)</sup>			200		ns	
V <sub>OVP</sub>	Over-Voltage Protection	V <sub>CC</sub> = 15V, V <sub>FB</sub> = 2V	5.5	6.0	6.5	V	
t <sub>OVP</sub>	Over-Voltage Protection Blanking Time		2	3	4	μsec	
T <sub>SD</sub>	Thermal Shutdown Temperature <sup>(13)</sup>		125	140	155	°C	
<b>SYNC SECTION</b>							
V <sub>SH</sub>	Sync Threshold Voltage		0.55	0.70	0.85	V	
V <sub>SL</sub>			0.14	0.20	0.26	V	
t <sub>sync</sub>	Sync Delay Time <sup>(13)(15)</sup>			300		ns	
<b>TOTAL DEVICE SECTION</b>							
I <sub>OP</sub>	Operating Supply Current (Control Part Only)	V <sub>CC</sub> = 15V	1	3	5	mA	
I <sub>START</sub>	Start Current	V <sub>CC</sub> = V <sub>START</sub> - 0.1V (before V <sub>CC</sub> reaches V <sub>START</sub> )	270	360	450	μA	
I <sub>CH</sub>	Start-up Charging Current	V <sub>CC</sub> = 0V, V <sub>STR</sub> = min. 40V	0.65	0.85	1.00	mA	
V <sub>STR</sub>	Minimum V <sub>STR</sub> Supply Voltage			26		V	

### Notes:

13. Though guaranteed, it is not tested in the mass production.
14. Propagation delay in the control IC.
15. Include gate turn-on time.

### Comparison Between FSDM0x65RNB and FSQ-Series

Function	FSDM0x65RNB	FSQ-Series	FSQ-Series Advantages
Operation method	Constant frequency PWM	Quasi-resonant operation	<ul style="list-style-type: none"> <li>■ Improved efficiency by valley switching</li> <li>■ Reduced EMI noise</li> </ul>
EMI reduction	Frequency modulation	Valley switching & inherent frequency modulation	<ul style="list-style-type: none"> <li>■ Reduce EMI noise by two ways</li> </ul>
Burst-mode operation	Fixed burst peak	Advanced burst-mode	<ul style="list-style-type: none"> <li>■ Improved standby power by valley switching also in burst-mode</li> <li>■ Because the current peak during burst operation is dependent on <math>V_{FB}</math>, it is easier to solve audible noise</li> </ul>
Protection		AOCP	<ul style="list-style-type: none"> <li>■ Improved reliability through precise abnormal over-current protection</li> </ul>

## Typical Performance Characteristics

These characteristic graphs are normalized at  $T_A = 25^\circ\text{C}$ .

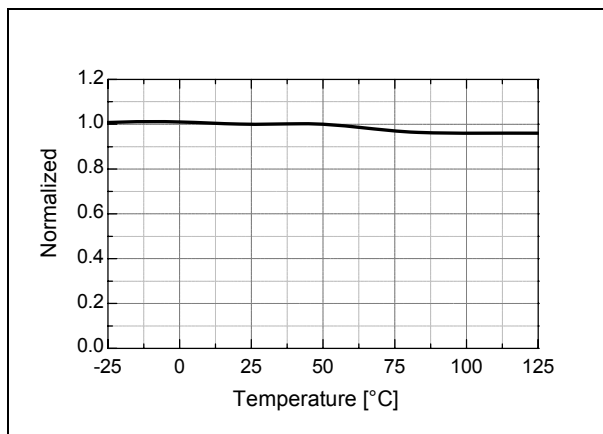

Figure 4. Operating Supply Current ( $I_{OP}$ ) vs.  $T_A$

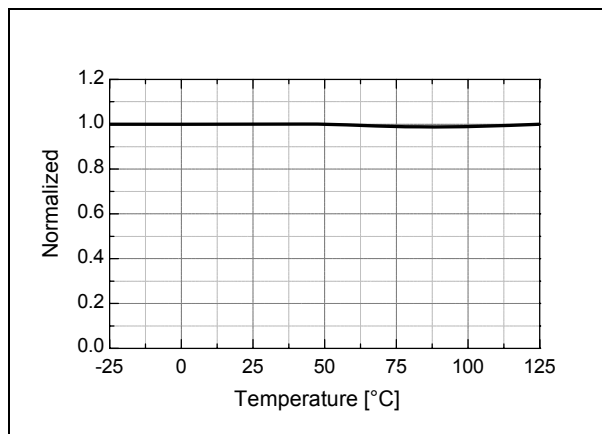

Figure 5. UVLO Start Threshold Voltage ( $V_{START}$ ) vs.  $T_A$

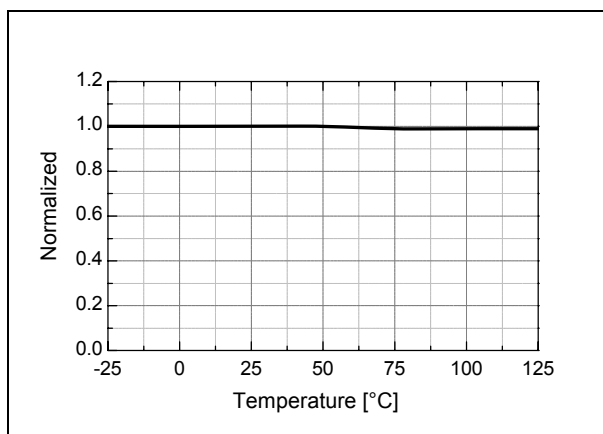

Figure 6. UVLO Stop Threshold Voltage ( $V_{STOP}$ ) vs.  $T_A$

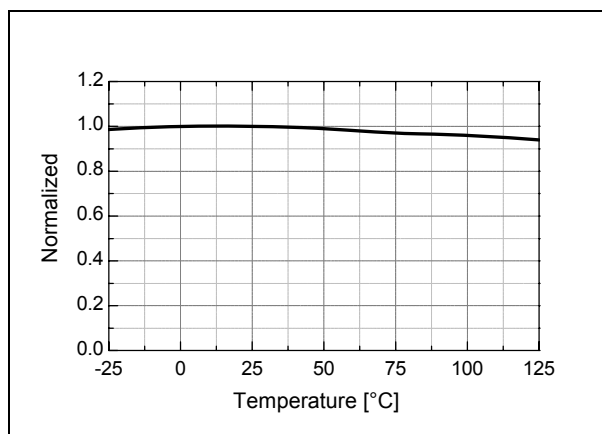

Figure 7. Start-up Charging Current ( $I_{CH}$ ) vs.  $T_A$

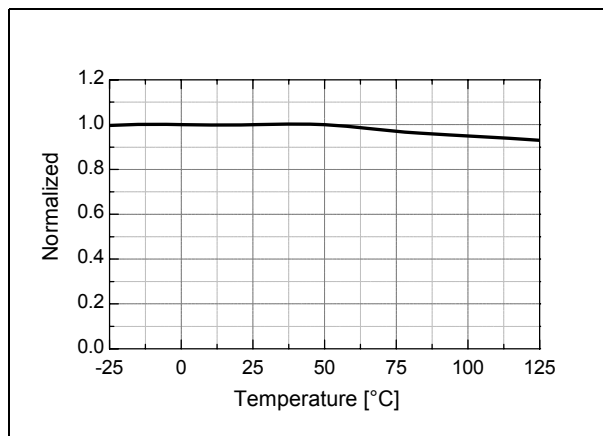

Figure 8. Initial Switching Frequency ( $f_S$ ) vs.  $T_A$

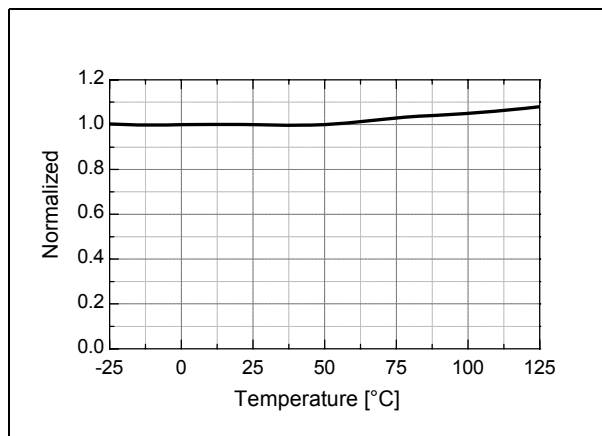

Figure 9. Maximum On Time ( $t_{ON.MAX}$ ) vs.  $T_A$



### Typical Performance Characteristics (Continued)

These characteristic graphs are normalized at  $T_A = 25^\circ\text{C}$ .

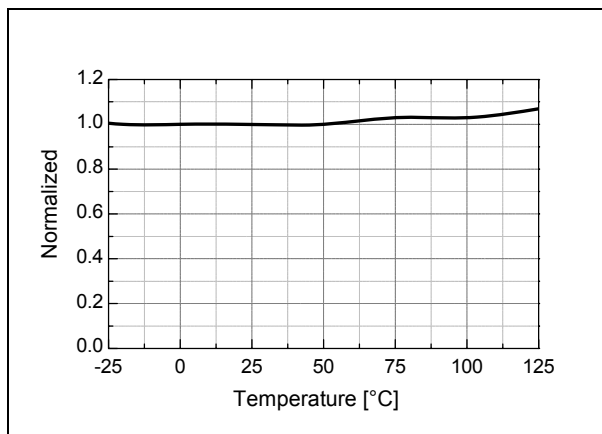

Figure 10. Blanking Time ( $t_B$ ) vs.  $T_A$

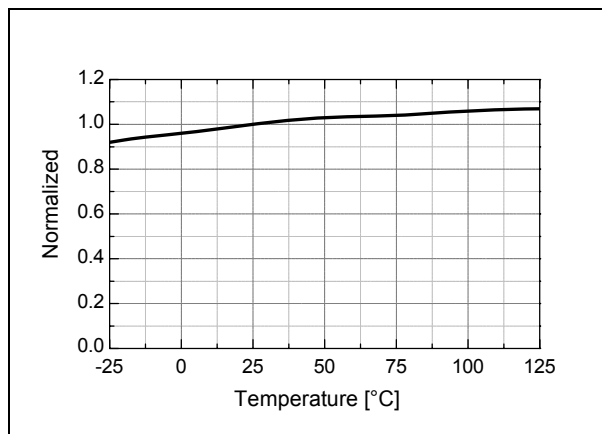

Figure 11. Feedback Source Current ( $I_{FB}$ ) vs.  $T_A$

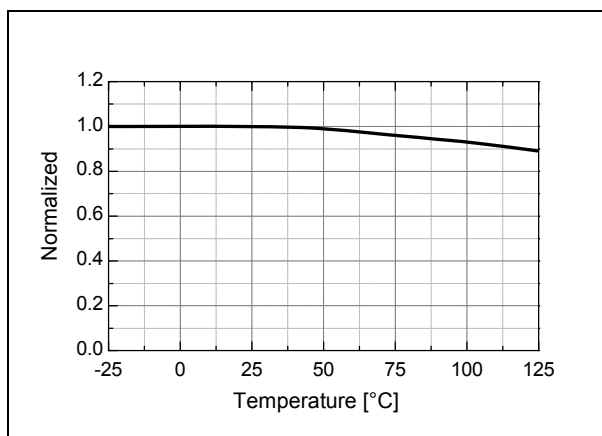

Figure 12. Shutdown Delay Current ( $I_{DELAY}$ ) vs.  $T_A$

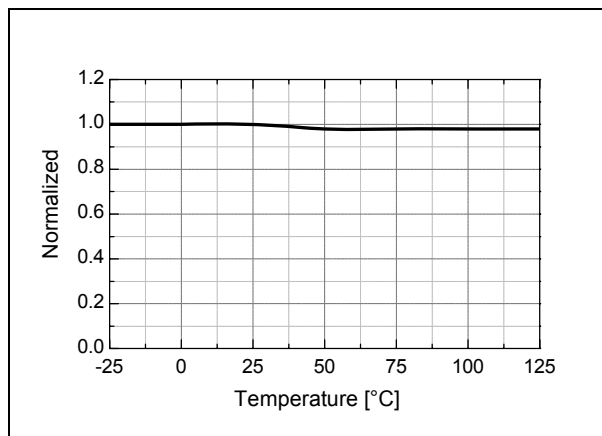

Figure 13. Burst-Mode High Threshold Voltage ( $V_{burh}$ ) vs.  $T_A$

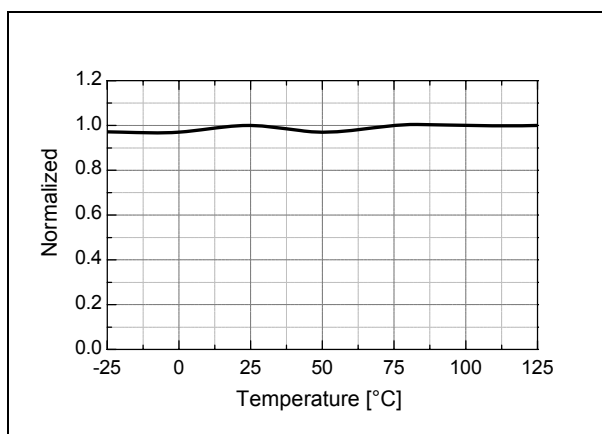

Figure 14. Burst-Mode Low Threshold Voltage ( $V_{burl}$ ) vs.  $T_A$

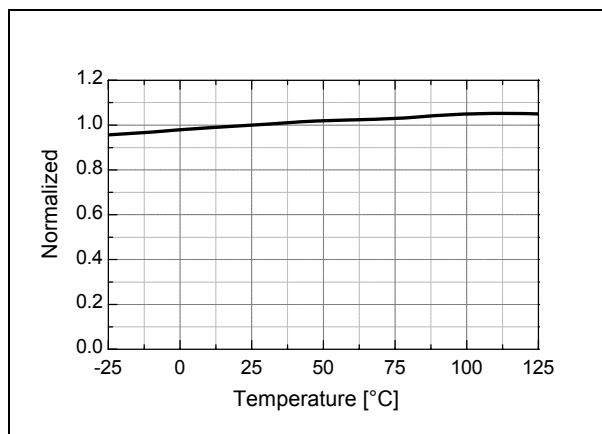

Figure 15. Peak Current Limit ( $I_{LIM}$ ) vs.  $T_A$

### Typical Performance Characteristics (Continued)

These characteristic graphs are normalized at  $T_A = 25^\circ\text{C}$ .

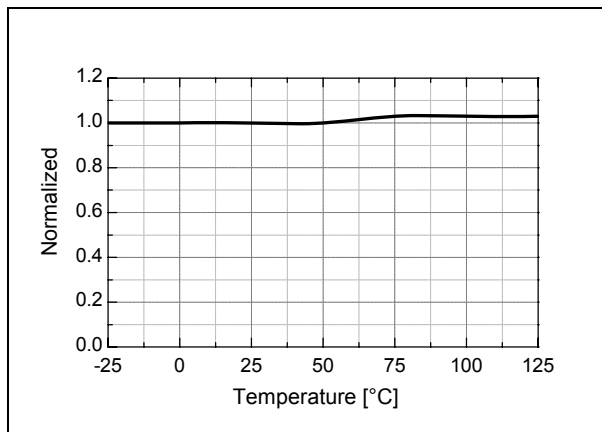

Figure 16. Sync High Threshold Voltage ( $V_{SH}$ ) vs.  $T_A$

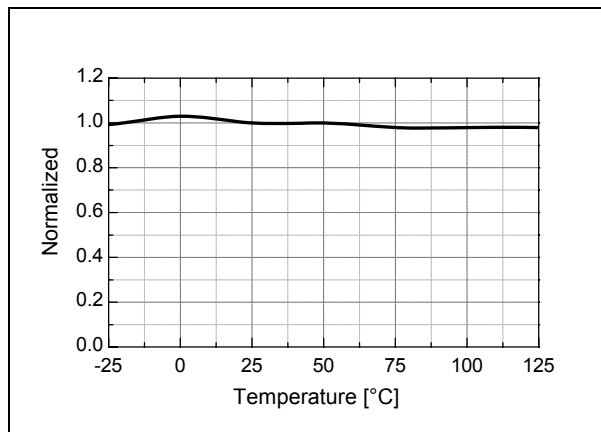

Figure 17. Sync Low Threshold Voltage ( $V_{SL}$ ) vs.  $T_A$

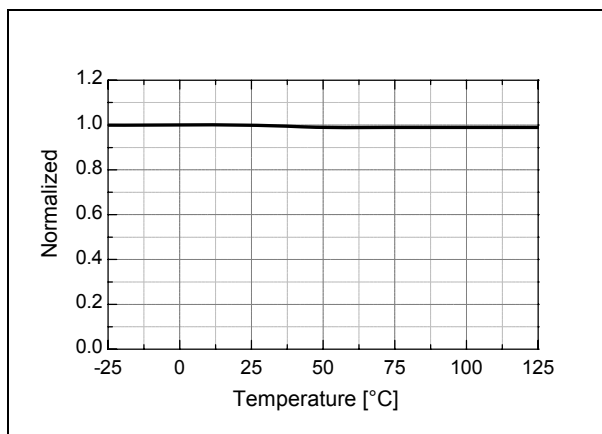

Figure 18. Shutdown Feedback Voltage ( $V_{SD}$ ) vs.  $T_A$

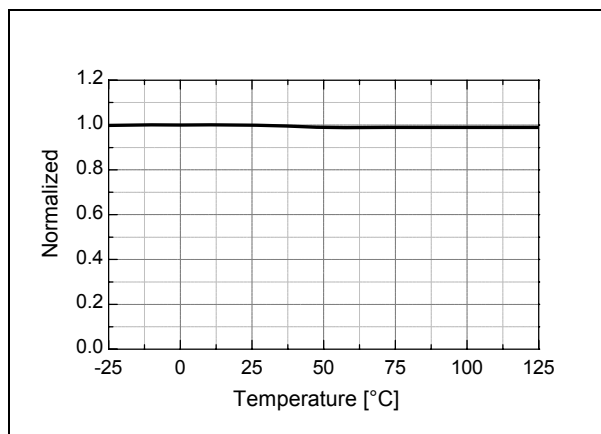

Figure 19. Over-Voltage Protection ( $V_{OV}$ ) vs.  $T_A$

## Functional Description

**1. Startup:** At startup, an internal high-voltage current source supplies the internal bias and charges the external capacitor ( $C_a$ ) connected to the  $V_{CC}$  pin, as illustrated in Figure 20. When  $V_{CC}$  reaches 12V, the FPS begins switching and the internal high-voltage current source is disabled. The FPS continues its normal switching operation and the power is supplied from the auxiliary transformer winding unless  $V_{CC}$  goes below the stop voltage of 8V.

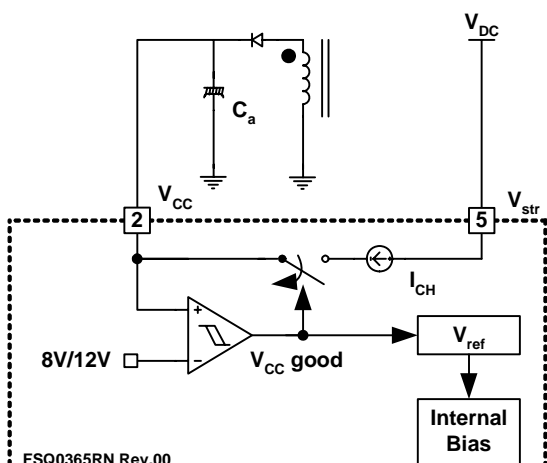

Figure 20. Start-up Circuit

**2. Feedback Control:** FPS employs current mode control, as shown in Figure 21. An opto-coupler (such as the FOD817A) and shunt regulator (such as the KA431) are typically used to implement the feedback network. Comparing the feedback voltage with the voltage across the  $R_{sense}$  resistor makes it possible to control the switching duty cycle. When the reference pin voltage of the shunt regulator exceeds the internal reference voltage of 2.5V, the opto-coupler LED current increases, thus pulling down the feedback voltage and reducing the duty cycle. This event typically happens when the input voltage is increased or the output load is decreased.

**2.1 Pulse-by-Pulse Current Limit:** Because current mode control is employed, the peak current through the SenseFET is limited by the inverting input of PWM comparator ( $V_{FB}^*$ ), as shown in Figure 21. Assuming that the 0.9mA current source flows only through the internal resistor ( $3R + R = 2.8k$ ), the cathode voltage of diode D2 is about 2.5V. Since D1 is blocked when the feedback voltage ( $V_{FB}$ ) exceeds 2.5V, the maximum voltage of the cathode of D2 is clamped at this voltage, thus clamping  $V_{FB}^*$ . Therefore, the peak value of the current through the SenseFET is limited.

**2.2 Leading Edge Blanking (LEB):** At the instant the internal SenseFET is turned on, a high-current spike usually occurs through the SenseFET, caused by primary-side capacitance and secondary-side rectifier reverse recovery. Excessive voltage across the  $R_{sense}$  resistor would lead to incorrect feedback operation in the current mode PWM control. To counter this effect, the FPS employs a leading edge blanking (LEB) circuit. This circuit inhibits the PWM comparator for a short time ( $t_{LEB}$ ) after the SenseFET is turned on.

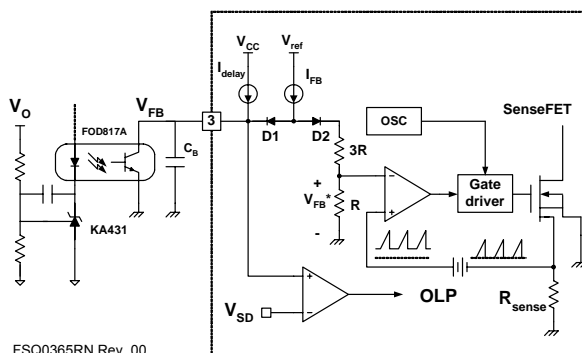

Figure 21. Pulse-Width-Modulation (PWM) Circuit

**3. Synchronization:** The FSQ-series employs a quasi-resonant switching technique to minimize the switching noise and loss. The basic waveforms of the quasi-resonant converter are shown in Figure 22. To minimize the MOSFET's switching loss, the MOSFET should be turned on when the drain voltage reaches its minimum value, as shown in Figure 22. The minimum drain voltage is indirectly detected by monitoring the  $V_{CC}$  winding voltage, as shown in Figure 22.

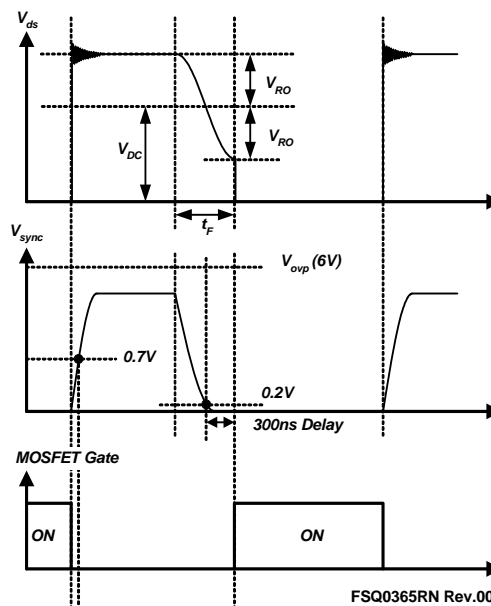
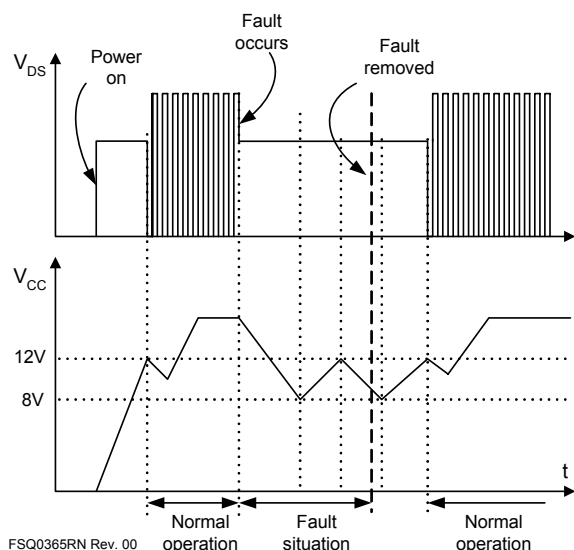

Figure 22. Quasi-Resonant Switching Waveforms

**4. Protection Circuits:** The FSQ-series has several self-protective functions, such as Overload Protection (OLP), Abnormal Over-Current protection (AOCP), Over-Voltage Protection (OVP), and Thermal Shutdown (TSD). All the protections are implemented as auto-restart mode. Once the fault condition is detected, switching is terminated and the SenseFET remains off. This causes  $V_{CC}$  to fall. When  $V_{CC}$  falls down to the Under-Voltage Lockout (UVLO) stop voltage of 8V, the protection is reset and start-up circuit charges  $V_{CC}$  capacitor. When the  $V_{CC}$  reaches the start voltage of 12V, the FSQ-series resumes normal operation. If the fault condition is not removed, the SenseFET remains off and  $V_{CC}$  drops to stop voltage again. In this manner, the auto-restart can alternately enable and disable the switching of the power SenseFET until the fault condition is eliminated. Because these protection circuits are fully integrated into the IC without external components, the reliability is improved without increasing cost.



**Figure 23. Auto Restart Protection Waveforms**

**4.1 Overload Protection (OLP):** Overload is defined as the load current exceeding its normal level due to an unexpected abnormal event. In this situation, the protection circuit should trigger to protect the SMPS. However, even when the SMPS is in the normal operation, the overload protection circuit can be triggered during the load transition. To avoid this undesired operation, the overload protection circuit is designed to trigger only after a specified time to determine whether it is a transient situation or a true overload situation. Because of the pulse-by-pulse current limit capability, the maximum peak current through the Sense FET is limited, and therefore the maximum input power is restricted with a given input

voltage. If the output consumes more than this maximum power, the output voltage ( $V_O$ ) decreases below the set voltage. This reduces the current through the opto-coupler LED, which also reduces the opto-coupler transistor current, thus increasing the feedback voltage ( $V_{FB}$ ). If  $V_{FB}$  exceeds 2.8V, D1 is blocked and the 5 $\mu$ A current source starts to charge CB slowly up to  $V_{CC}$ . In this condition,  $V_{FB}$  continues increasing until it reaches 6V, when the switching operation is terminated, as shown in Figure 24. The delay time for shutdown is the time required to charge CB from 2.8V to 6V with 5 $\mu$ A. A 20 ~ 50ms delay time is typical for most applications.

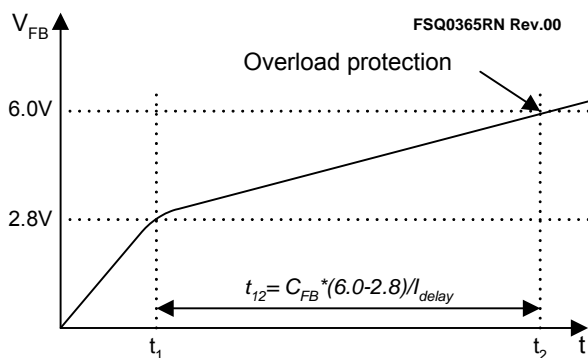

**Figure 24. Overload Protection**

**4.2 Abnormal Over-Current Protection (AOCP):** When the secondary rectifier diodes or the transformer pins are shorted, a steep current with extremely high-di/dt can flow through the SenseFET during the LEB time. Even though the FSQ-series has OLP (Overload Protection), it is not enough to protect the FSQ-series in that abnormal case, since severe current stress is imposed on the SenseFET until OLP triggers. The FSQ-series has an internal AOCP (Abnormal Over-Current Protection) circuit as shown in Figure 25. When the gate turn-on signal is applied to the power SenseFET, the AOCP block is enabled and monitors the current through the sensing resistor. The voltage across the resistor is compared with a preset AOCP level. If the sensing resistor voltage is greater than the AOCP level, the set signal is applied to the latch, resulting in the shutdown of the SMPS.

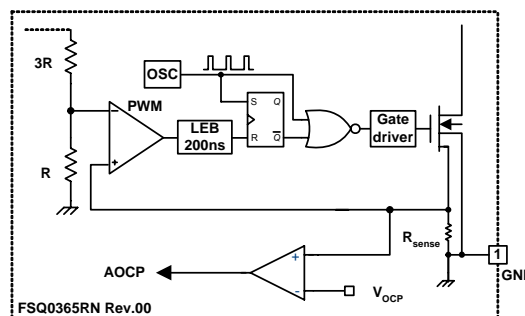

**Figure 25. Abnormal Over-Current Protection**

**4.3 Over-Voltage Protection (OVP):** If the secondary side feedback circuit malfunctions or a solder defect causes an opening in the feedback path, the current through the opto-coupler transistor becomes almost zero. Then,  $V_{FB}$  climbs up in a similar manner to the overload situation, forcing the preset maximum current to be supplied to the SMPS until the overload protection triggers. Because more energy than required is provided to the output, the output voltage may exceed the rated voltage before the overload protection triggers, resulting in the breakdown of the devices in the secondary side. To prevent this situation, an OVP circuit is employed. In general, the peak voltage of the sync signal is proportional to the output voltage and the FSQ-series uses a sync signal instead of directly monitoring the output voltage. If the sync signal exceeds 6V, an OVP is triggered, shutting down the SMPS. To avoid undesired triggering of OVP during normal operation, the peak voltage of the sync signal should be designed below 6V.

**4.4 Thermal Shutdown (TSD):** The SenseFET and the control IC are built in one package. This makes it easy for the control IC to detect the abnormal over temperature of the SenseFET. If the temperature exceeds  $\sim 150^{\circ}\text{C}$ , the thermal shutdown triggers.

**5. Soft-Start:** The FPS has an internal soft-start circuit that increases PWM comparator inverting input voltage with the SenseFET current slowly after it starts up. The typical soft-start time is 15ms. The pulse width to the power switching device is progressively increased to establish the correct working conditions for transformers, inductors, and capacitors. The voltage on the output capacitors is progressively increased with the intention of smoothly establishing the required output voltage. This mode helps prevent transformer saturation and reduces stress on the secondary diode during startup.

**6. Burst Operation:** To minimize power dissipation in standby mode, the FPS enters burst-mode operation. As the load decreases, the feedback voltage decreases. As shown in Figure 26, the device automatically enters burst-mode when the feedback voltage drops below  $V_{BURL}$  (350mV). At this point, switching stops and the output voltages start to drop at a rate dependent on standby current load. This causes the feedback voltage to rise. Once it passes  $V_{BURH}$  (550mV), switching resumes. The feedback voltage then falls and the process repeats. Burst-mode operation alternately enables and disables switching of the power SenseFET, thereby reducing switching loss in standby mode.

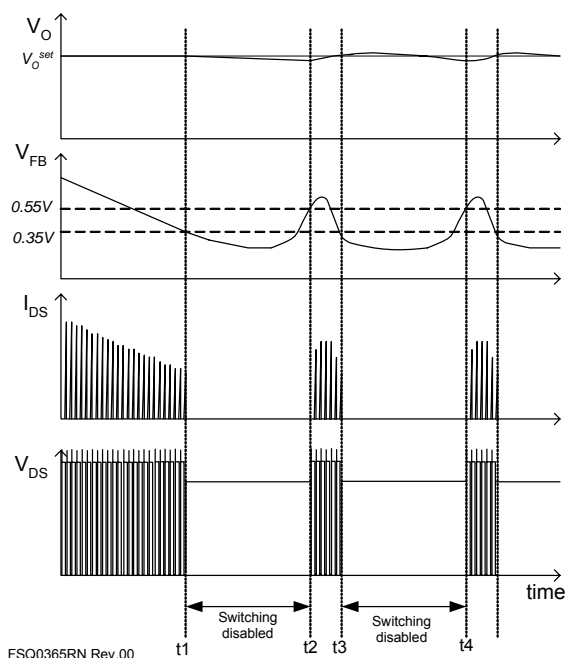

**Figure 26. Waveforms of Burst Operation**

**7. Switching Frequency Limit:** To minimize switching loss and EMI (Electromagnetic Interference), the MOSFET turns on when the drain voltage reaches its minimum value in quasi-resonant operation. However, this causes switching frequency to increase at light load conditions. As the load decreases, the peak drain current diminishes and the switching frequency increases. This results in severe switching losses at light-load condition, as well as intermittent switching and audible noise. Because of these problems, the quasi-resonant converter topology has limitations in a wide range of applications.

To overcome this problem, FSQ-series employs a frequency-limit function, as shown in Figures 27 and 28. Once the SenseFET is turned on, the next turn-on is prohibited during the blanking time ( $t_B$ ). After the blanking time, the controller finds the valley within the detection time window ( $t_W$ ) and turns on the MOSFET, as shown in Figures 27 and 28 (Cases A, B, and C). If no valley is found during  $t_W$ , the internal SenseFET is forced to turn on at the end of  $t_W$  (Case D). Therefore, our devices have a minimum switching frequency of 55kHz and a maximum switching frequency of 67kHz, as shown in Figure 28.

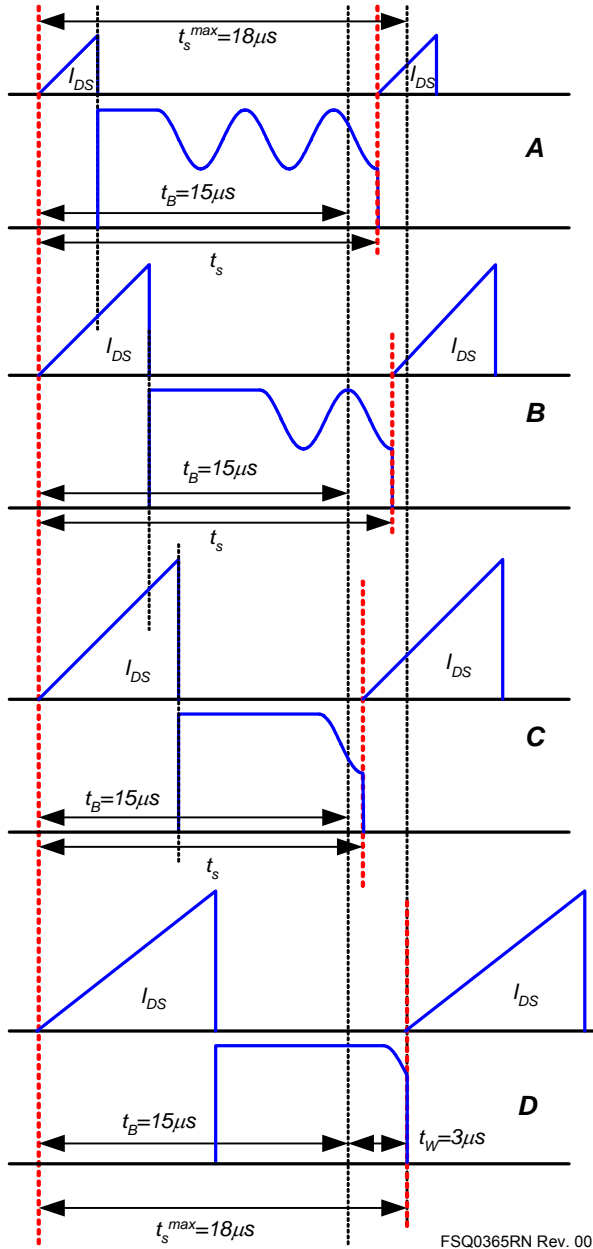

Figure 27. QRC Operation with Limited Frequency

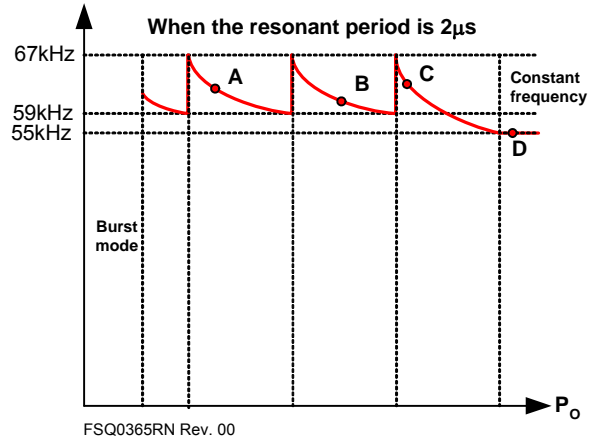

Figure 28. Switching Frequency Range



## 2. Transformer

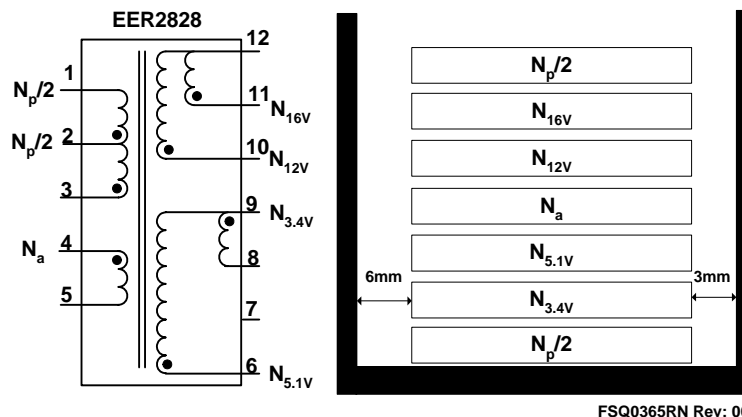

Figure 30. Transformer Schematic Diagram

## 3. Winding Specification

No	Pin (s→f)	Wire	Turns	Winding Method
$N_p/2$	3 → 2	0.25 <sup>φ</sup> × 1	50	Center Solenoid Winding
Insulation: Polyester Tape t = 0.050mm, 2 Layers				
$N_{3.4V}$	9 → 8	0.33 <sup>φ</sup> × 2	4	Center Solenoid Winding
Insulation: Polyester Tape t = 0.050mm, 2 Layers				
$N_{5V}$	6 → 9	0.33 <sup>φ</sup> × 1	2	Center Solenoid Winding
Insulation: Polyester Tape t = 0.050mm, 2 Layers				
$N_a$	4 → 5	0.25 <sup>φ</sup> × 1	16	Center Solenoid Winding
Insulation: Polyester Tape t = 0.050mm, 2 Layers				
$N_{12V}$	10 → 12	0.33 <sup>φ</sup> × 3	14	Center Solenoid Winding
Insulation: Polyester Tape t = 0.050mm, 3 Layers				
$N_{16V}$	11 → 12	0.33 <sup>φ</sup> × 3	18	Center Solenoid Winding
Insulation: Polyester Tape t = 0.050mm, 2 Layers				
$N_p/2$	2 → 1	0.25 <sup>φ</sup> × 1	50	Center Solenoid Winding
Insulation: Polyester Tape t = 0.050mm, 2 Layers				

## 4. Electrical Characteristics

	Pin	Specification	Remarks
Inductance	1 - 3	1.4mH ± 10%	100kHz, 1V
Leakage	1 - 3	25μH Max.	Short all other pins

## 5. Core & Bobbin

- Core: EER2828 ( $A_e=86.66\text{mm}^2$ )
- Bobbin: EER2828



## 6. Demo Board Part List

Part	Value	Note	Part	Value	Note
<b>Resistor</b>			<b>Inductor</b>		
R102	56kΩ	1W	L201	10μH	
R103	5Ω	1/2W	L202	10μH	
R104	12kΩ	1/4W	L203	4.9μH	
R105	100kΩ	1/4W	L204	4.9μH	
R106	6.2kΩ	1/4W	<b>Diode</b>		
R107	6.2kΩ	1/4W	D101	IN4007	
R108	62Ω	1W	D102	IN4004	
R201	510Ω	1/4W	ZD101	1N4746A	
R202	1kΩ	1/4W	D103	1N4148	
R203	6.2kΩ	1/4W	D201	UF4003	
R204	20kΩ	1/4W	D202	UF4003	
R205	6kΩ	1/4W	D203	SB360	
<b>Capacitor</b>			D204	SB360	
C101	100nF/275V <sub>AC</sub>	Box Capacitor	<b>IC</b>		
C102	100nF/275V <sub>AC</sub>	Box Capacitor	IC101	FSQ0365RN	FPS™
C103	33μF/400V	Electrolytic Capacitor	IC201	KA431 (TL431)	Voltage reference
C104	10nF/630V	Film Capacitor	IC202	FOD817A	Opto-coupler
C105	47nF/50V	Mono Capacitor	<b>Fuse</b>		
C106	100nF/50V	SMD (1206)	Fuse	2A/250V	
C107	22μF/50V	Electrolytic Capacitor	<b>NTC</b>		
C110	33pF/50V	Ceramic Capacitor	RT101	5D-9	
C201	470μF/35V	Electrolytic Capacitor	<b>Bridge Diode</b>		
C202	470μF/35V	Electrolytic Capacitor	BD101	2KBP06M2N257	Bridge Diode
C203	470μF/35V	Electrolytic Capacitor	<b>Line Filter</b>		
C204	470μF/35V	Electrolytic Capacitor	LF101	40mH	
C205	1000μF/10V	Electrolytic Capacitor	<b>Transformer</b>		
C206	1000μF/10V	Electrolytic Capacitor	T101		
C207	1000μF/10V	Electrolytic Capacitor	<b>Varistor</b>		
C208	1000μF/10V	Electrolytic Capacitor	TNR	10D471K	
C209	100nF /50V	Ceramic Capacitor			

### Package Dimensions

#### 8-DIP

Dimensions are in millimeters unless otherwise noted.

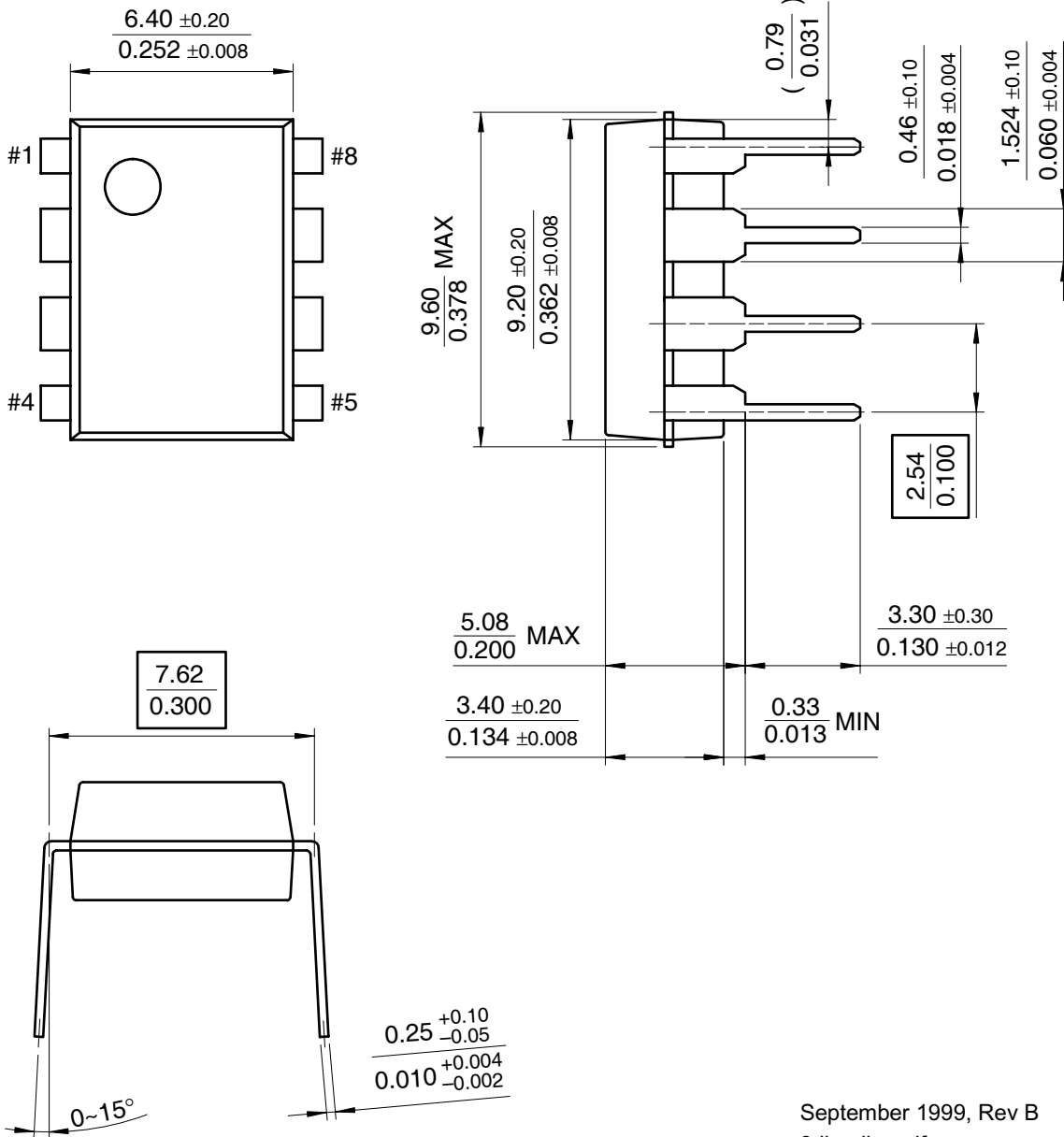

September 1999, Rev B  
8dip\_dim.pdf

## TRADEMARKS

The following are registered and unregistered trademarks Fairchild Semiconductor owns or is authorized to use and is not intended to be an exhaustive list of all such trademarks.

ACEx™	GlobalOptoisolator™	OCXPro™	μSerDes™	TinyBuck™
ActiveArray™	GTO™	OPTOLOGIC®	SILENT SWITCHER®	TinyLogic®
Bottomless™	HiSeC™	OPTOPLANAR™	SMART START™	TINYOPTO™
Build it Now™	I <sup>2</sup> C™	PACMAN™	SPM™	TinyPower™
CoolFET™	i-Lo™	POP™	Stealth™	TinyPWM™
CROSSVOL™	ImpliedDisconnect™	Power247™	SuperFET™	TruTranslation™
DOME™	IntelliMAX™	PowerEdge™	SuperSOT™-3	UHC™
EcoSPARK™	ISOPLANAR™	PowerSaver™	SuperSOT™-6	UltraFET®
E <sup>2</sup> CMOS™	LittleFET™	PowerTrench®	SuperSOT™-8	UniFET™
EnSigna™	MICROCOUPLER™	QFET®	SyncFET™	VCX™
FACT™	MicroFET™	QS™	TCM™	Wire™
FACT Quiet Series™	MicroPak™	QT Optoelectronics™	TinyBoost™	
FAST®	MICROWIRE™	Quiet Series™		
FASTr™	MSX™	RapidConfigure™	Across the board. Around the world.™	
FPS™	MSXPro™	RapidConnect™	Programmable Active Droop™	
FRFET™	OCX™	ScalarPump™	The Power Franchise®	

## DISCLAIMER

FAIRCHILD SEMICONDUCTOR RESERVES THE RIGHT TO MAKE CHANGES WITHOUT FURTHER NOTICE TO ANY PRODUCTS HEREIN TO IMPROVE RELIABILITY, FUNCTION OR DESIGN. FAIRCHILD DOES NOT ASSUME ANY LIABILITY ARISING OUT OF THE APPLICATION OR USE OF ANY PRODUCT OR CIRCUIT DESCRIBED HEREIN; NEITHER DOES IT CONVEY ANY LICENSE UNDER ITS PATENT RIGHTS, NOR THE RIGHTS OF OTHERS. THESE SPECIFICATIONS DO NOT EXPAND THE TERMS OF FAIRCHILD'S WORLDWIDE TERMS AND CONDITIONS, SPECIFICALLY THE WARRANTY THEREIN, WHICH COVERS THESE PRODUCTS.

## LIFE SUPPORT POLICY

FAIRCHILD'S PRODUCTS ARE NOT AUTHORIZED FOR USE AS CRITICAL COMPONENTS IN LIFE SUPPORT DEVICES OR SYSTEMS WITHOUT THE EXPRESS WRITTEN APPROVAL OF FAIRCHILD SEMICONDUCTOR CORPORATION.

As used herein:

- Life support devices or systems are devices or systems which, (a) are intended for surgical implant into the body or (b) support or sustain life, and (c) whose failure to perform when properly used in accordance with instructions for use provided in the labeling, can be reasonably expected to result in a significant injury of the user.
- A critical component in any component of a life support device, or system whose failure to perform can be reasonably expected to cause the failure of the life support device or system, or to affect its safety or effectiveness.

## PRODUCT STATUS DEFINITIONS

### Definition of Terms

Datasheet Identification	Product Status	Definition
Advance Information	Formative or In Design	This datasheet contains the design specifications for product development. Specifications may change in any manner without notice.
Preliminary	First Production	This datasheet contains preliminary data; supplementary data will be published at a later date. Fairchild Semiconductor reserves the right to make changes at any time without notice to improve design.
No Identification Needed	Full Production	This datasheet contains final specifications. Fairchild Semiconductor reserves the right to make changes at any time without notice to improve design.
Obsolete	Not In Production	This datasheet contains specifications on a product that has been discontinued by Fairchild Semiconductor. The datasheet is printed for reference information only.

Rev. I20