

High Efficiency, 3A Output, Synchronous Step Down

Features

- Two 45mΩ (typical) MOSFETs for high efficiency at 3A loads
- 300kHz to 2MHz Switching Frequency
- 0.827V±3% Voltage Reference Over Temperature
- Synchronizes to External Clock
- Adjustable Soft Start
- UV and OV Power Good Output
- Low Operating and Shutdown Quiescent Current
- Safe Start-up into Pre-Biased Output
- Cycle by Cycle Current Limit, Thermal and Frequency Fold Back Protection
- Thermally Enhanced 3mm × 3mm 16-pin QFN

Applications

- Low-Voltage, High-Density Power Systems
- Point of Load Regulation for High Performance DSPs, FPGAs, ASICs and Microprocessors
- Broadband, Networking and Optical Communication Infrastructure

Ordering Information

ORDER NUMBER	Marking	TEMP. RANGE	PACKAGE (Green)
G5173R41U	5173	-40°C to +85°C	TQFN3X3-16
G5173R41D	5173	-40°C to +85°C	TQFN3X3-16

Note: R4: TQFN3X3-16

1: Bonding Code
U & D: Tape & Reel

General Description

The G5173 device is a full featured 5.5V, 3A synchronous step down current mode converter with two integrated MOSFETs.

The G5173 enables small designs by integrating the MOSFETs, implementing current mode control to reduce external component count, reducing inductor size by enabling up to 2MHz switching frequency, and minimizing the IC footprint with a small 3mm x 3mm thermally enhanced QFN package.

The G5173 provides accurate regulation for a variety of loads with an accurate ±3% Voltage Reference (VREF) over temperature.

Efficiency is maximized through the integrated 45mΩ MOSFETs and 350µA typical supply current. Using the enable pin, shutdown supply current is reduced to 2µA by entering a shutdown mode.

Under voltage lockout is internally set at 2.6V, but can be increased by programming the threshold with a resistor network on the enable pin. The output voltage startup ramp is controlled by the soft start pin. An open drain power good signal indicates the output is within 93% to 107% of its nominal voltage.

Frequency fold back and thermal shutdown protects the device during an over-current condition.

Pin Configuration

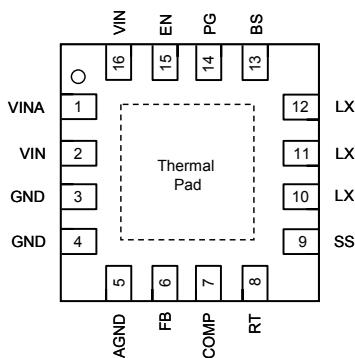

G5173 TQFN3X3-16

Note: Recommend connecting the Thermal Pad to the Ground for excellent power dissipation.

Typical Application Circuit

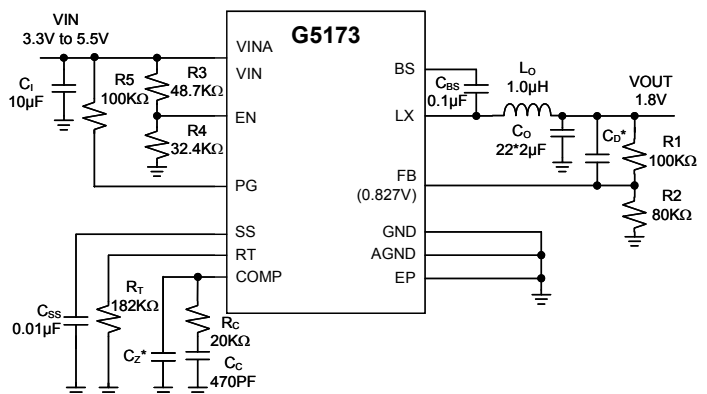

* Option

* VINA must connect to VIN