

Power Distribution Switch

Features

- 85mΩ High-Side MOSFET
- Available with 4 Versions of Current Limits with Foldback
- Operating Range: 2.7V to 5.5V
- 400μS Typical Rise Time
- Under Voltage Lockout
- 65μA Quiescent Supply Current
- 1μA Maximum Shutdown Supply Current
- Logic Level Enable Pin, Available with Active-High or Active-Low Version
- No Reverse Current when Power Off
- Deglitched Open-Drain Over-Current Flag Output (\overline{OC})
- Available for 3 Kinds of Pin Out (G5250 E/F/G/H) (G5250 I/J/K/L) (G5250M/N/P)
- Output Shutdown Pull-Low Resistor (G5250 I/J/K/L/M/N)
- SOT-23-5 and TSOT-23-5 Package
- UL Approved #E232223
- Nemko IEC 60950-1 CB/CCA_scheme certification Report #67291
- CSA Approved #230321

Applications

- High-Side Power Protection Switch
- USB Power Management
- USB Host and Self-Powered Bubs
- USB Bus-Powered Hubs
- Hot Plug-In Power Supplies
- Battery-Charger Circuits

General Description

The G5250 is an integrated 85mΩ power switch for self-powered and bus-powered Universal Serial Bus (USB) applications.

Several Protection features include current limiting with foldback, and thermal shutdown to prevent catastrophic switch failure caused by increasing power dissipation when continuous heavy loads or short circuit occurs. And a built-in charge pump is used to drive the N-channel MOSFET that is free of parasitic body diode to eliminate any reversed current flow across the switch when it is powered off.

G5250E/F/G/H, G5250I/J/K/L and G5250M/N/P has open-drain \overline{OC} output reports over-current or over-temperature event and has typical 9ms deglitch timeout period.

Pin Configuration

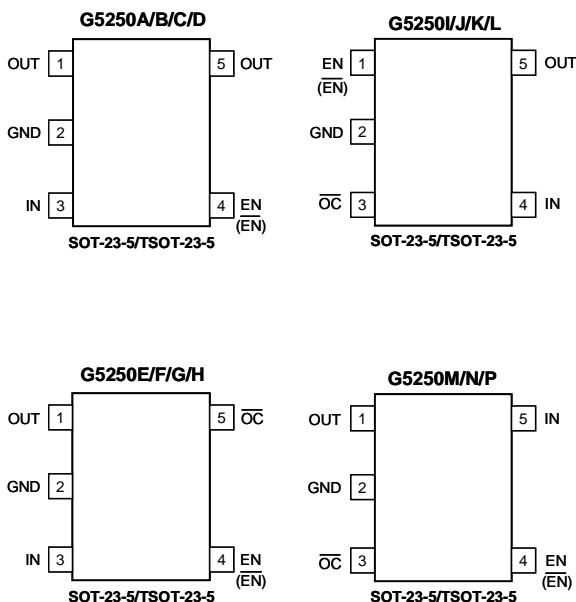

Typical Application Circuit

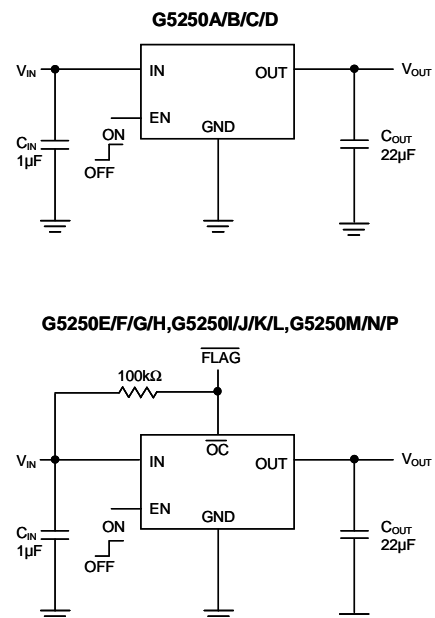

UL Recognized Component

Ordering Information

ORDER NUMBER	MARKING	ENABLE	OC OUTPUT	OUTPUT SHUTDOWN DISCHARGE	CURRENT LIMIT	TEMP. RANGE	PACKAGE (Green)
G5250A1T1U	50A1x	Active High	No	No	2.5A	-40°C to +85°C	SOT-23-5
G5250A2T1U	50A2x	Active Low	No	No	2.5A	-40°C to +85°C	SOT-23-5
G5250B1T1U	50B1x	Active High	No	No	2.0A	-40°C to +85°C	SOT-23-5
G5250B2T1U	50B2x	Active Low	No	No	2.0A	-40°C to +85°C	SOT-23-5
G5250C1T1U	50C1x	Active High	No	No	1.5A	-40°C to +85°C	SOT-23-5
G5250C2T1U	50C2x	Active Low	No	No	1.5A	-40°C to +85°C	SOT-23-5
G5250D1T1U	50D1x	Active High	No	No	1.0A	-40°C to +85°C	SOT-23-5
G5250D2T1U	50D2x	Active Low	No	No	1.0A	-40°C to +85°C	SOT-23-5
G5250E1T1U	50E1x	Active High	Yes	No	2.5A	-40°C to +85°C	SOT-23-5
G5250E2T1U	50E2x	Active Low	Yes	No	2.5A	-40°C to +85°C	SOT-23-5
G5250F1T1U	50F1x	Active High	Yes	No	2.0A	-40°C to +85°C	SOT-23-5
G5250F2T1U	50F2x	Active Low	Yes	No	2.0A	-40°C to +85°C	SOT-23-5
G5250G1T1U	50G1x	Active High	Yes	No	1.5A	-40°C to +85°C	SOT-23-5
G5250G2T1U	50G2x	Active Low	Yes	No	1.5A	-40°C to +85°C	SOT-23-5
G5250H1T1U	50H1x	Active High	Yes	No	1.0A	-40°C to +85°C	SOT-23-5
G5250H2T1U	50H2x	Active Low	Yes	No	1.0A	-40°C to +85°C	SOT-23-5
G5250I1T1U	50I1x	Active High	Yes	Yes	2.5A	-40°C to +85°C	SOT-23-5
G5250I2T1U	50I2x	Active Low	Yes	Yes	2.5A	-40°C to +85°C	SOT-23-5
G5250J1T1U	50J1x	Active High	Yes	Yes	2.0A	-40°C to +85°C	SOT-23-5
G5250J2T1U	50J2x	Active Low	Yes	Yes	2.0A	-40°C to +85°C	SOT-23-5
G5250K1T1U	50K1x	Active High	Yes	Yes	1.5A	-40°C to +85°C	SOT-23-5
G5250K2T1U	50K2x	Active Low	Yes	Yes	1.5A	-40°C to +85°C	SOT-23-5
G5250L1T1U	50L1x	Active High	Yes	Yes	1.0A	-40°C to +85°C	SOT-23-5
G5250L2T1U	50L2x	Active Low	Yes	Yes	1.0A	-40°C to +85°C	SOT-23-5
G5250M1T1U	50M1x	Active High	Yes	Yes	1.0A	-40°C to +85°C	SOT-23-5
G5250M2T1U	50M2x	Active Low	Yes	Yes	1.0A	-40°C to +85°C	SOT-23-5
G5250N1T1U	50N1x	Active High	Yes	Yes	1.5A	-40°C to +85°C	SOT-23-5
G5250N2T1U	50N2x	Active Low	Yes	Yes	1.5A	-40°C to +85°C	SOT-23-5
G5250P1T1U	50P1x	Active High	Yes	Yes	2A	-40°C to +85°C	SOT-23-5
G5250P2T1U	50P2x	Active Low	Yes	Yes	2A	-40°C to +85°C	SOT-23-5

Note: T1: SOT-23-5

U: Tape & Reel

Ordering Information

ORDER NUMBER	MARKING	ENABLE	OC OUTPUT	OUTPUT SHUTDOWN DISCHARGE	CURRENT LIMIT	TEMP. RANGE	PACKAGE (Green)
G5250A1TOU	50A1x	Active High	No	No	2.5A	-40°C to +85°C	TSOT-23-5
G5250A2TOU	50A2x	Active Low	No	No	2.5A	-40°C to +85°C	TSOT-23-5
G5250B1TOU	50B1x	Active High	No	No	2.0A	-40°C to +85°C	TSOT-23-5
G5250B2TOU	50B2x	Active Low	No	No	2.0A	-40°C to +85°C	TSOT-23-5
G5250C1TOU	50C1x	Active High	No	No	1.5A	-40°C to +85°C	TSOT-23-5
G5250C2TOU	50C2x	Active Low	No	No	1.5A	-40°C to +85°C	TSOT-23-5
G5250D1TOU	50D1x	Active High	No	No	1.0A	-40°C to +85°C	TSOT-23-5
G5250D2TOU	50D2x	Active Low	No	No	1.0A	-40°C to +85°C	TSOT-23-5
G5250E1TOU	50E1x	Active High	Yes	No	2.5A	-40°C to +85°C	TSOT-23-5
G5250E2TOU	50E2x	Active Low	Yes	No	2.5A	-40°C to +85°C	TSOT-23-5
G5250F1TOU	50F1x	Active High	Yes	No	2.0A	-40°C to +85°C	TSOT-23-5
G5250F2TOU	50F2x	Active Low	Yes	No	2.0A	-40°C to +85°C	TSOT-23-5
G5250G1TOU	50G1x	Active High	Yes	No	1.5A	-40°C to +85°C	TSOT-23-5
G5250G2TOU	50G2x	Active Low	Yes	No	1.5A	-40°C to +85°C	TSOT-23-5
G5250H1TOU	50H1x	Active High	Yes	No	1.0A	-40°C to +85°C	TSOT-23-5
G5250H2TOU	50H2x	Active Low	Yes	No	1.0A	-40°C to +85°C	TSOT-23-5
G5250I1TOU	50I1x	Active High	Yes	Yes	2.5A	-40°C to +85°C	TSOT-23-5
G5250I2TOU	50I2x	Active Low	Yes	Yes	2.5A	-40°C to +85°C	TSOT-23-5
G5250J1TOU	50J1x	Active High	Yes	Yes	2.0A	-40°C to +85°C	TSOT-23-5
G5250J2TOU	50J2x	Active Low	Yes	Yes	2.0A	-40°C to +85°C	TSOT-23-5
G5250K1TOU	50K1x	Active High	Yes	Yes	1.5A	-40°C to +85°C	TSOT-23-5
G5250K2TOU	50K2x	Active Low	Yes	Yes	1.5A	-40°C to +85°C	TSOT-23-5
G5250L1TOU	50L1x	Active High	Yes	Yes	1.0A	-40°C to +85°C	TSOT-23-5
G5250L2TOU	50L2x	Active Low	Yes	Yes	1.0A	-40°C to +85°C	TSOT-23-5
G5250M1TOU	50M1x	Active High	Yes	Yes	1.0A	-40°C to +85°C	TSOT-23-5
G5250M2TOU	50M2x	Active Low	Yes	Yes	1.0A	-40°C to +85°C	TSOT-23-5
G5250N1TOU	50N1x	Active High	Yes	Yes	1.5A	-40°C to +85°C	TSOT-23-5
G5250N2TOU	50N2x	Active Low	Yes	Yes	1.5A	-40°C to +85°C	TSOT-23-5
G5250P1TOU	50P1x	Active High	Yes	Yes	2A	-40°C to +85°C	TSOT-23-5
G5250P2TOU	50P2x	Active Low	Yes	Yes	2A	-40°C to +85°C	TSOT-23-5

Note:TO: TSOT-23-5

U: Tape & Reel

Absolute Maximum Ratings

Supply Voltage (V_{IN})	6V
Output Voltage (V_{OUT})	6V
Output Current (I_{OUT})	Internally Limited
Enable Input (V_{EN})	-0.3V to 6V
Thermal Resistance Junction to Ambient, (θ_{JA})*	
SOT-23-5/TSOT-23-5	250°C/W
Continuous Power Dissipation ($T_A=25^\circ\text{C}$)*	
SOT-23-5/TSOT-23-5	0.4W
Thermal Resistance Junction to Case, (θ_{JC})	
SOT-23-5/TSOT-23-5	.60°C/W

Storage Temperature (T_S)	-65°C to +150°C
Junction Temperature	150°C
Reflow Temperature (soldering, 10sec)	260°C
ESD protection	2kV

Operating Ratings

Supply Voltage (V_{IN})	+3V to +5.5V
Operating Temperature (T_A)	-40°C to +85°C

* Please refer to Minimum Footprint PCB Layout Section.

Electrical Characteristics

$V_{IN} = 5V$, $C_{IN}=1\mu F$, $C_{OUT}=1\mu F$, $R_L=10\Omega$, $T_A = 25^\circ\text{C}$, unless otherwise noted.

PARAMETER	CONDITION	MIN	TYP	MAX	UNITS
Input Voltage Range		2.7	---	5.5	V
Output MOS $R_{DS(ON)}$	G5250A1/G5250A2/G5250E1/G5250E2/G5250I1/G5250I2, $I_{OUT}=2A$	---	85	95	m Ω
	G5250B1/G5250B2/G5250F1/G5250F2/G5250J1/G5250J2/ G5250P1/G5250P2, $I_{OUT}=1.5A$				
	G5250C1/G5250C2/G5250G1/G5250G2/G5250K1/G5250K2, G5250N1/G5250N2, $I_{OUT}=1A$				
	G5250D1/G5250D2/G5250H1/G5250H2/G5250L1/G5250L2/ G5250M1/G5250M2, $I_{OUT}=0.5A$				
Supply Current		---	65	95	μA
Output Turn-on Rising Time	$R_L=10\Omega$, 90% Settling	---	400	---	μs
Output Turn-off Falling Time	$R_L=5\Omega$, $C_{OUT}=1\mu F$, 90% Settling	---	1.8	---	ms
Current Limit Threshold	G5250A1/G5250A2/G5250E1/G5250E2/G5250I1/G5250I2, $V_{OUT}=4V$, $2.7V < V_{IN} < 5.5V$	2	2.5	3.5	A
	G5250B1/G5250B2/G5250F1/G5250F2/G5250J1/G5250J2/ G5250P1/G5250P2, $V_{OUT}=4V$, $2.7V < V_{IN} < 5.5V$	1.5	2	2.8	
	G5250C1/G5250C2/G5250G1/G5250G2/G5250K1/G5250K2/ G5250N1/G5250N2, $V_{OUT}=4V$, $2.7V < V_{IN} < 5.5V$	1.1	1.5	2.1	
	G5250D1/G5250D2/G5250H1/G5250H2/G5250L1/G5250L2/ G5250M1/G5250M2, $V_{OUT}=4V$, $2.7V < V_{IN} < 5.5V$	0.7	1	1.4	
Short-circuit Current	G5250A1/G5250A2/G5250E1/G5250E2/G5250I1/G5250I2, $V_{OUT}=0V$, $2.7V < V_{IN} < 5.5V$	0.2	1.6	2.3	A
	G5250B1/G5250B2/G5250F1/G5250F2/G5250J1/G5250J2/ G5250P1/G5250P2, $V_{OUT}=0V$, $2.7V < V_{IN} < 5.5V$	0.2	1.3	1.9	
	G5250C1/G5250C2/G5250G1/G5250G2/G5250K1/G5250K2/ G5250N1/G5250N2, $V_{OUT}=0V$, $2.7V < V_{IN} < 5.5V$	0.2	1	1.4	
	G5250D1/G5250D2/G5250H1/G5250H2/G5250L1/G5250L2/ G5250M1/G5250M2, $V_{OUT}=0V$, $2.7V < V_{IN} < 5.5V$	0.2	0.67	1	
EN Input Threshold		1.4	1.6	1.8	V
Shutdown Supply Current		---	0.1	1	μA
Shutdown Pull-low Resistance	G5250 I/J/K/L/M/N only	---	75	150	Ω
Output Leakage Current	EN="0", $V_{OUT}=0V$	---	0.5	1	μA
V_{IN} Under Voltage Lockout		2.2	2.5	2.7	V
V_{IN} Under Voltage Hysteresis		---	200	---	mV
Thermal Limit		---	135	---	$^\circ\text{C}$
Thermal Limit Hysteresis		---	20	---	$^\circ\text{C}$
OC Deglitch	G5250E/F/G/H/I/J/K/L/M/N/P, OC assertion or deassertion	4	9	15	ms
OC Output Low Voltage	G5250E/F/G/H/I/J/K/L/M/N/P, $I_{OC} = 5mA$	---	---	0.4	V
OC Off-State Current	G5250E/F/G/H/I/J/K/L/M/N/P, $V_{OC} = 5V$	---	---	1	μA

Typical Performance Characteristics

($V_{IN}=5V$, G5250B1, $C_{IN}=1\mu F$, $C_{OUT}=1\mu F$, $V_{EN}=V_{IN}$, $T_A=25^\circ C$, unless otherwise noted.)

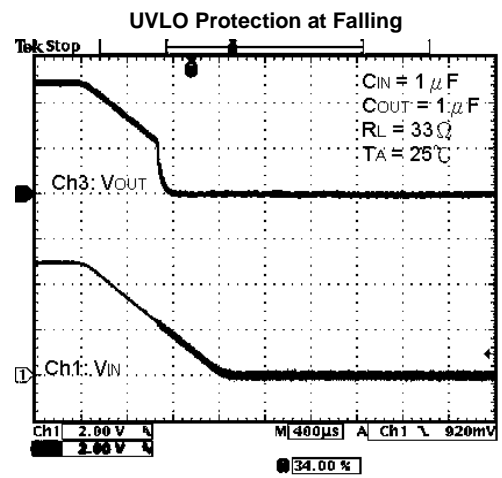
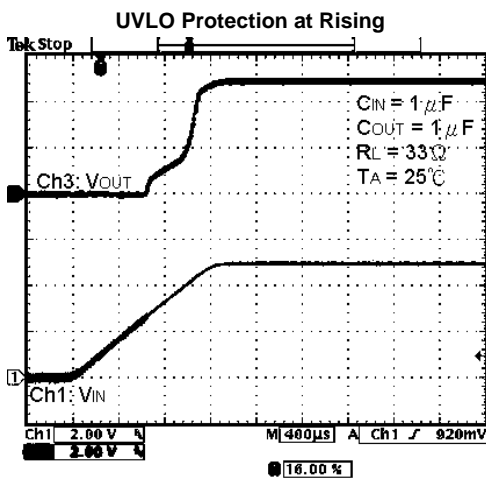
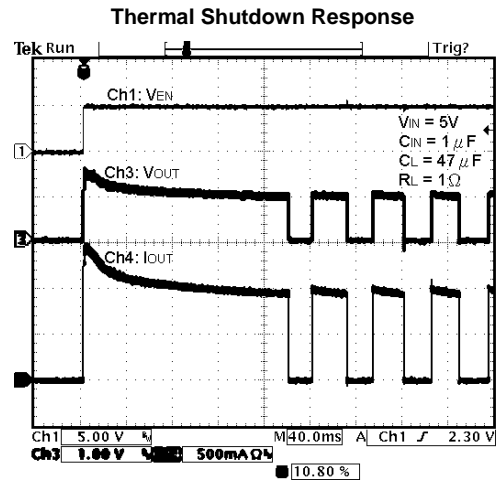
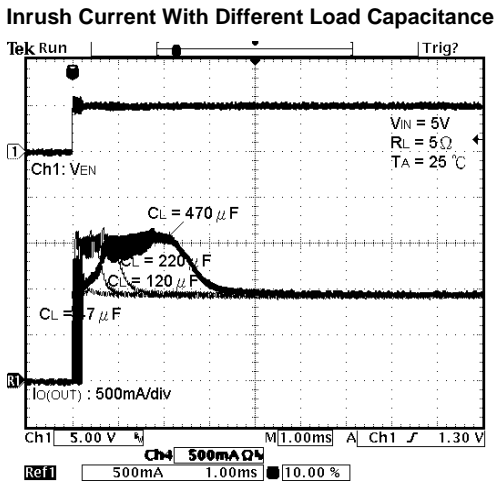
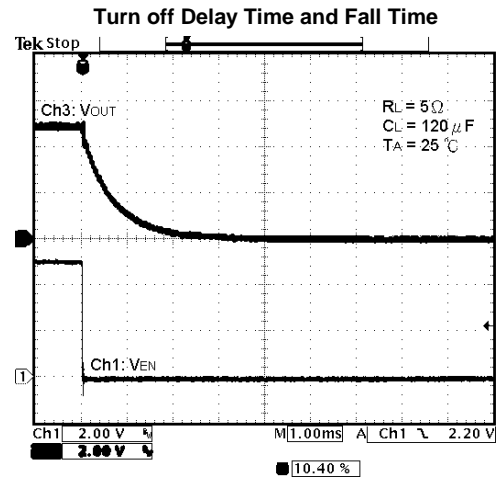
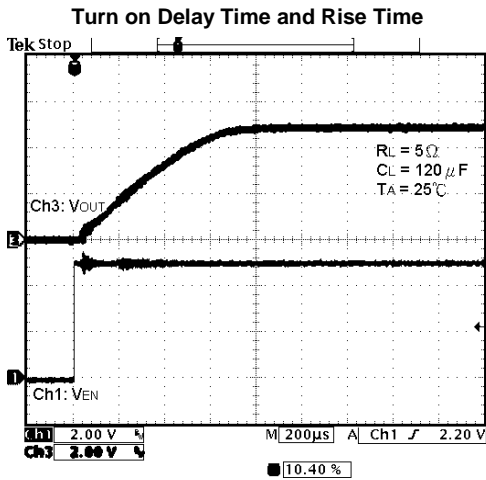

Typical Performance Characteristics (continued)

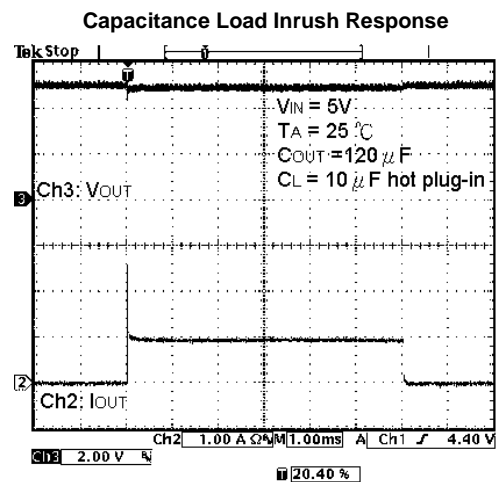
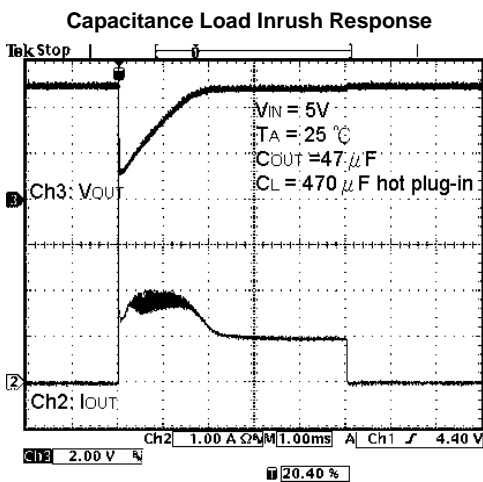
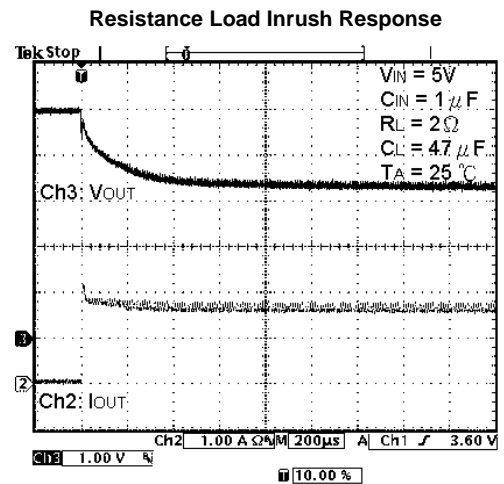
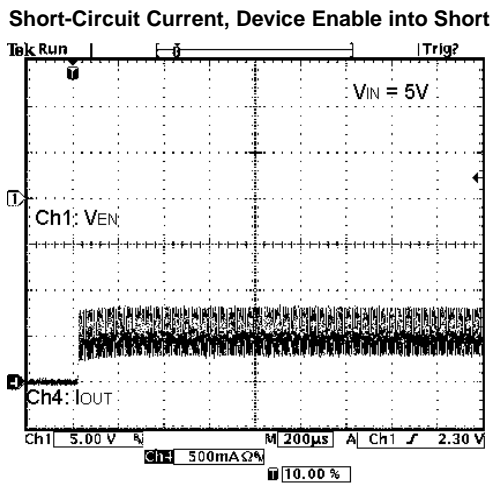
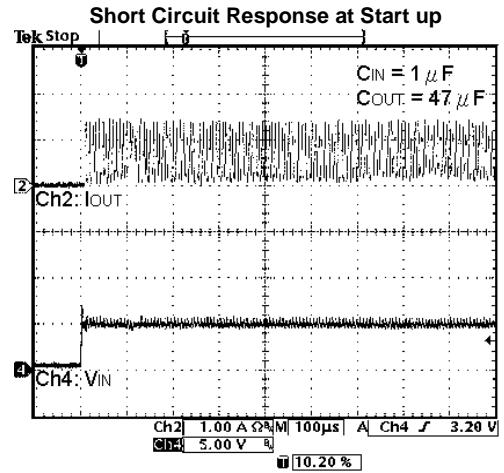
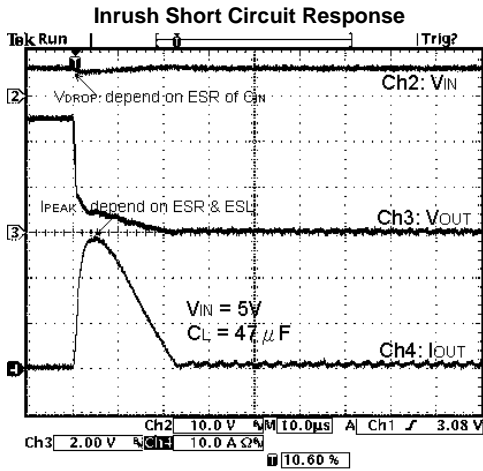

Typical Performance Characteristics (continued)

Supply Current vs. Input Voltage

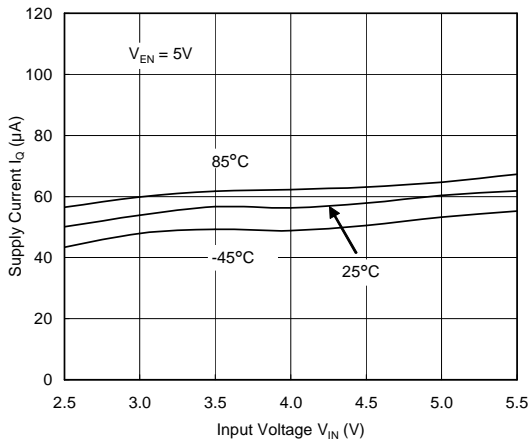

Shutdown Supply Current vs. Input Voltage

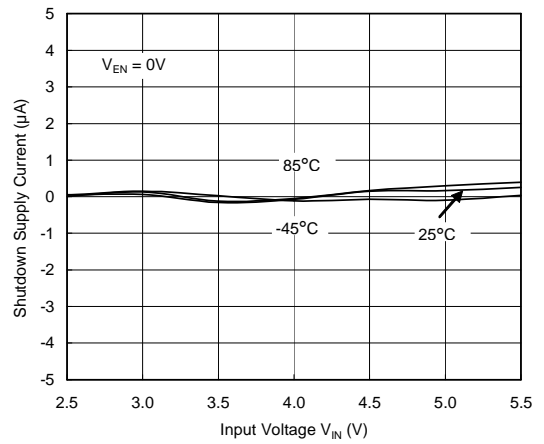

Enable Input Threshold vs. Input Voltage

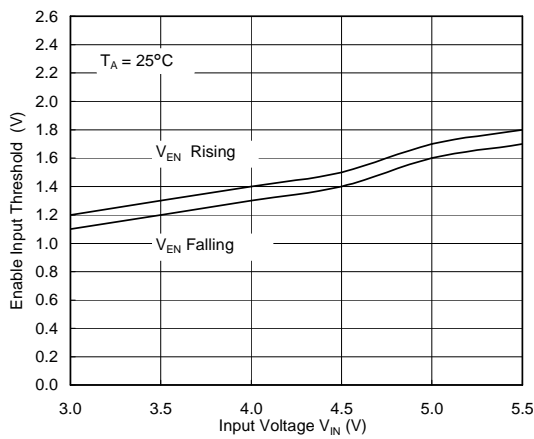

Enable Input Threshold vs. Temperature

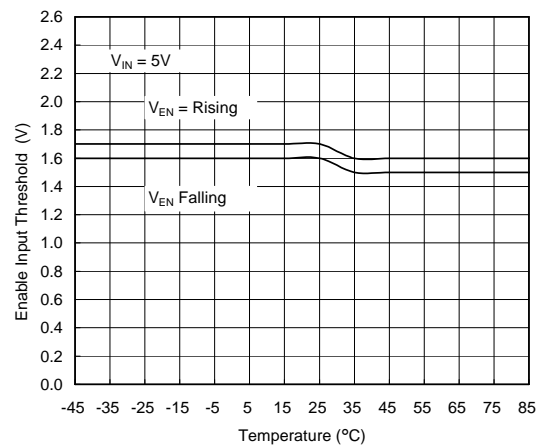

OC Deglitch Time vs. Input Voltage

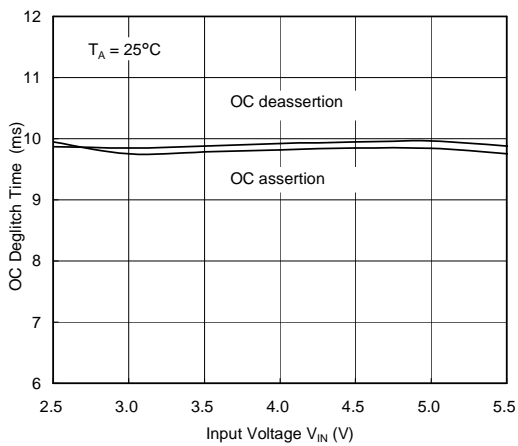

UVLO Threshold vs. Temperature

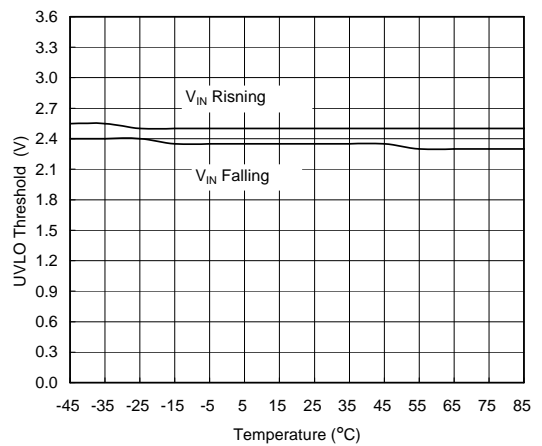

Typical Performance Characteristics (continued)

ON-Resistance vs. Input Voltage

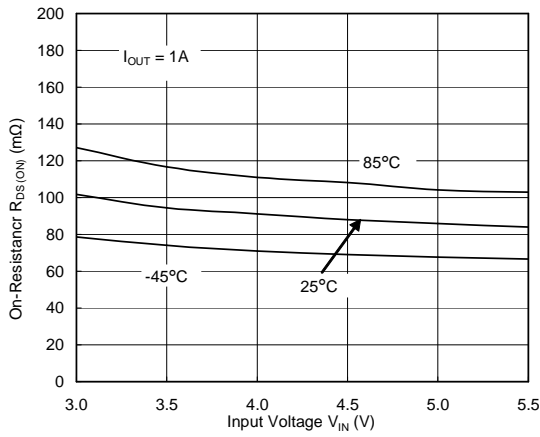

ON-Resistance vs. Temperature

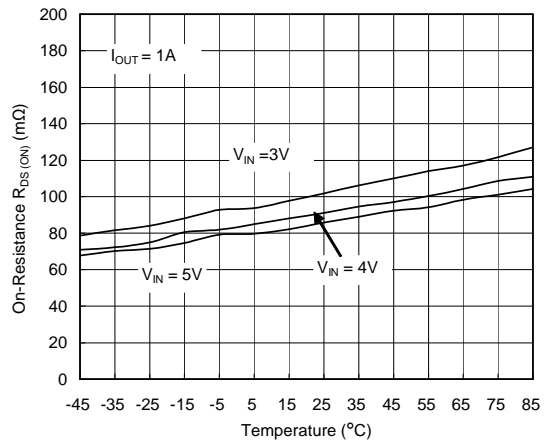

Current Limit Threshold vs. Input Voltage

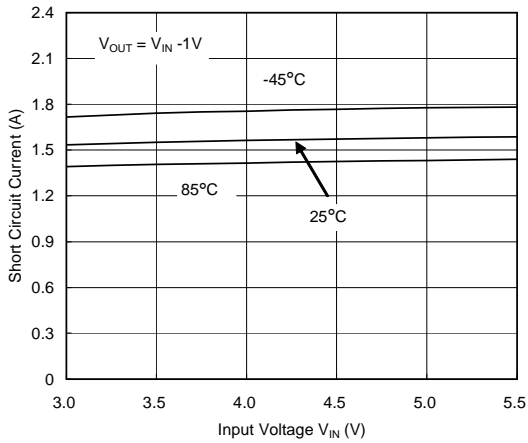

Short Circuit Current vs. Input Voltage

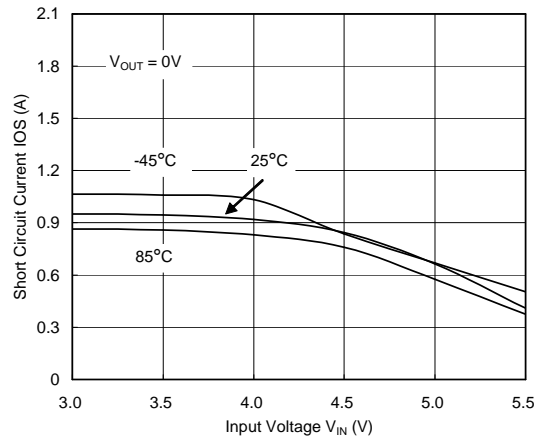

Over-Current Protection Characteristics

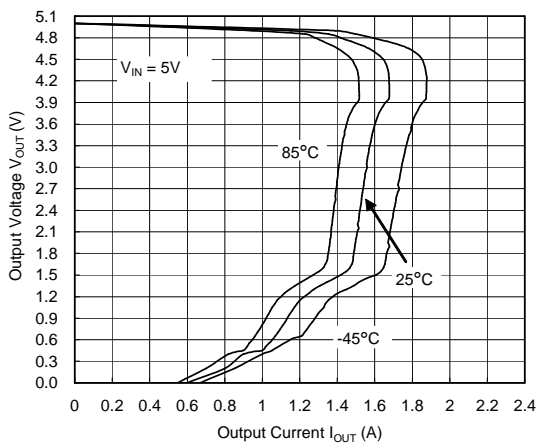

Over-Current Protection Characteristics

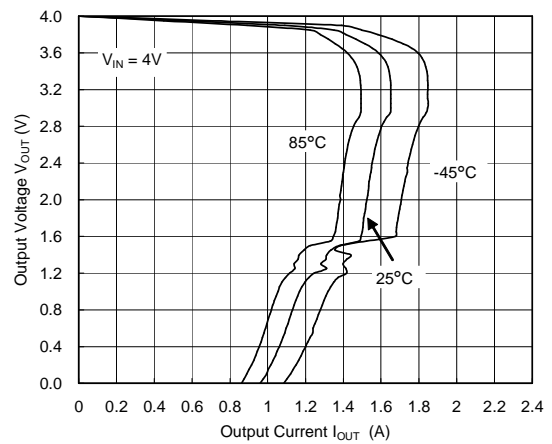

Pin Description

PIN				NAME	PIN FUNCTION
G5250A/B/C/D	G5250E/F/G/H	G5250I/J/K/L	G5250M/N/P		
1,5	1	5	1	OUT	Switch Output: Output MOSFET Source. Typically connect to switched side of load.
2	2	2	2	GND	Ground
3	3	4	5	IN	Input Supply: Output MOSFET Drain, which also supplies IC's internal circuitry. Connect to positive supply.
4	4	1	4	EN($\overline{\text{EN}}$)	Enable: Logic level enable input. Make sure EN pin never floating.
	5	3	3	$\overline{\text{OC}}$	Overcurrent open-drain $\overline{\text{OC}}$ output

Block Diagrams

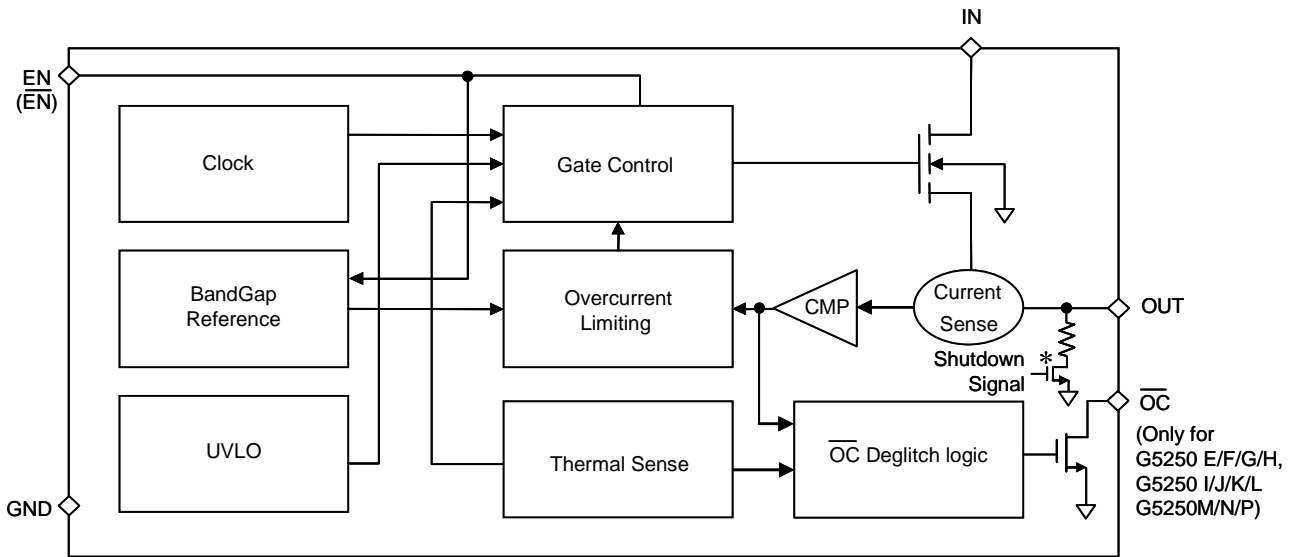

* For G5250 I/J/K/L only

Minimum Footprint PCB Layout Section

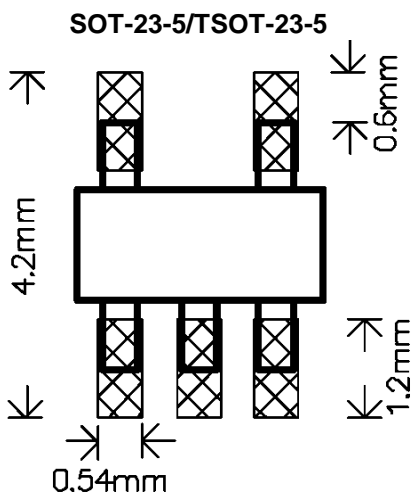

Functional Description

Input and Output

IN (input) is the power supply connection to the logic circuitry and the drain of the output MOSFET. OUT (output) is the source of the output MOSFET. In a typical application, current flows through the switch from IN to OUT toward the load. Both OUT pins must be connected together to the load.

Thermal Shutdown

Thermal shutdown protects G5250 from excessive power dissipation. If the die temperature exceeds 135°C, the MOSFETS switch is shut off. 20°C of hysteresis prevents the switch from turning on until the die temperature drops to 115°C. Thermal shutdown circuit functions only when the switch is enabled.

Undervoltage Lockout

UVLO (undervoltage lockout) prevents the output MOSFET from turning on until IN (input voltage) exceeds 2.5V typically. After the switch turns on, if the voltage drops below 2.3V typically, UVLO shuts off the output MOSFET.

Current Limiting

The typical current limit value of G5250 is 2.5A, 2A, 1.5A, 1A for G5250A(E)(I) / G5250B(F)(J)/P / G5250C(G)(K)(N) / G5250D(H)(L)(M) respectively. There is foldback of current limit when $V_{OUT} < 1.5V$ (See Typical Performance Characteristics).

\overline{OC} Function (G5250E/F/G/H, G5250I/J/K/L and G5250M/N/P)

The \overline{OC} open-drain output is asserted (active low) when an over current or overtemperature shutdown condition is encountered after a 9-ms deglitch timeout. The output remains asserted until the overcurrent or overtemperature condition is removed.

Applications Information

Supply Filtering

A 1 μ F bypass capacitor from IN to GND, located near the G5250, is strongly recommended to control supply transients. Without a bypass capacitor, an output short may cause sufficient ringing on the input (from supply lead inductance) to damage internal control circuitry.

Input transients must not exceed the absolute maximum supply voltage ($V_{IN\ max} = 6V$) even for a short duration.

EN, the Enable Input

EN must be driven logic high or logic low for a clearly defined input. Floating the input may cause unpredictable operation. EN should not be allowed to go negative with respect to GND.

Test Circuit

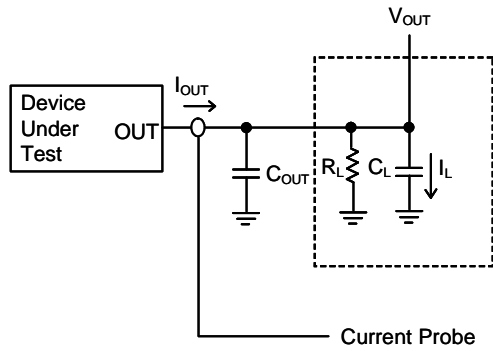

Timing Diagrams

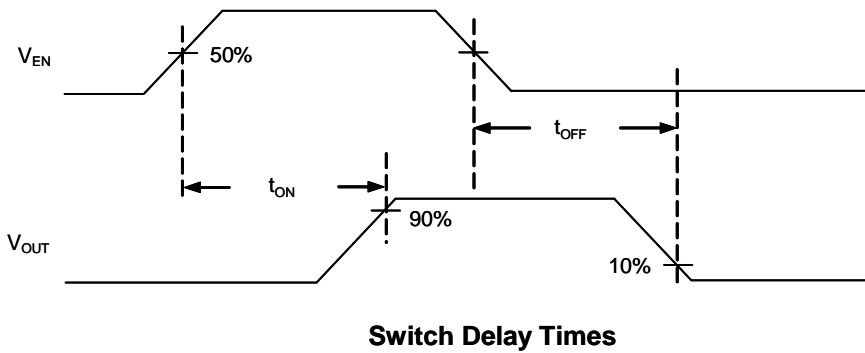
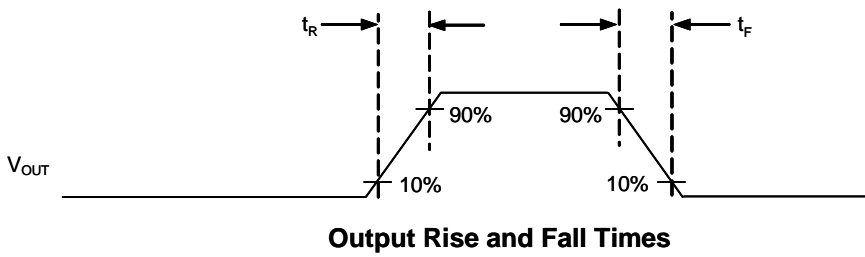

Package Information

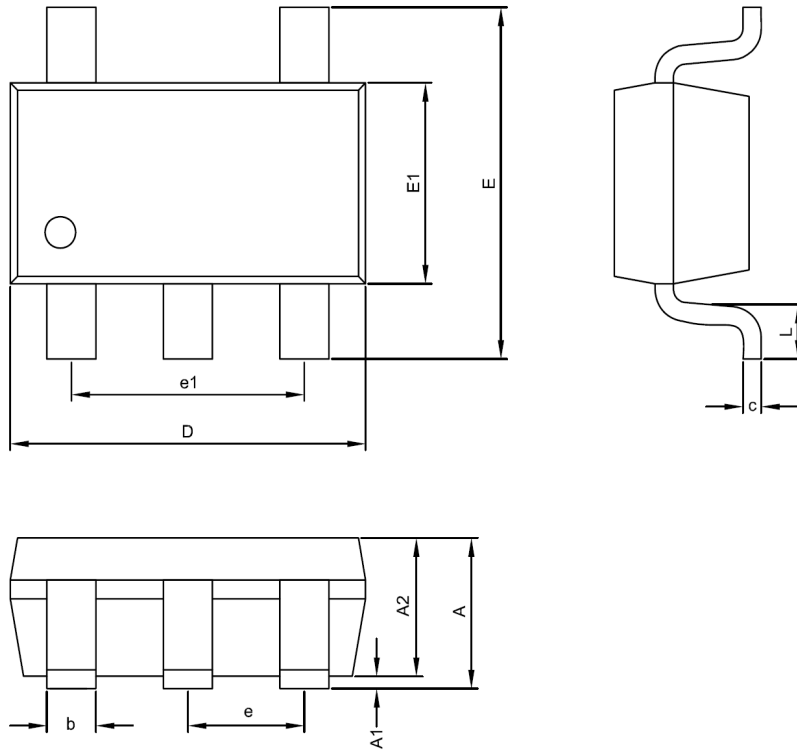

SOT-23-5 Package

Symble	DIMENSION IN MM			DIMENSION IN INCH		
	MIN.	NOM.	MAX.	MIN.	NOM.	MAX.
A	1.00	1.10	1.45	0.039	0.043	0.057
A1	0.00	---	0.15	0.000	---	0.006
A2	1.00	1.10	1.30	0.039	0.043	0.051
D	2.70	2.90	3.10	0.106	0.114	0.122
E	2.60	2.80	3.00	0.102	0.110	0.118
E1	1.50	1.60	1.70	0.059	0.063	0.067
c	0.08	0.15	0.25	0.003	0.006	0.010
b	0.30	0.40	0.50	0.012	0.016	0.020
e	0.95 BSC			0.037 BSC		
e1	1.90 BSC			0.075 BSC		
L	0.30	0.45	0.60	0.012	0.018	0.024

Taping Specification

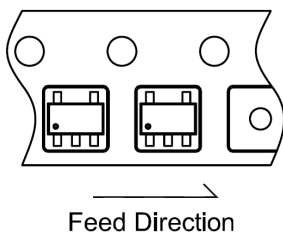

PACKAGE	Q'TY/REEL
SOT-23-5	3,000 ea

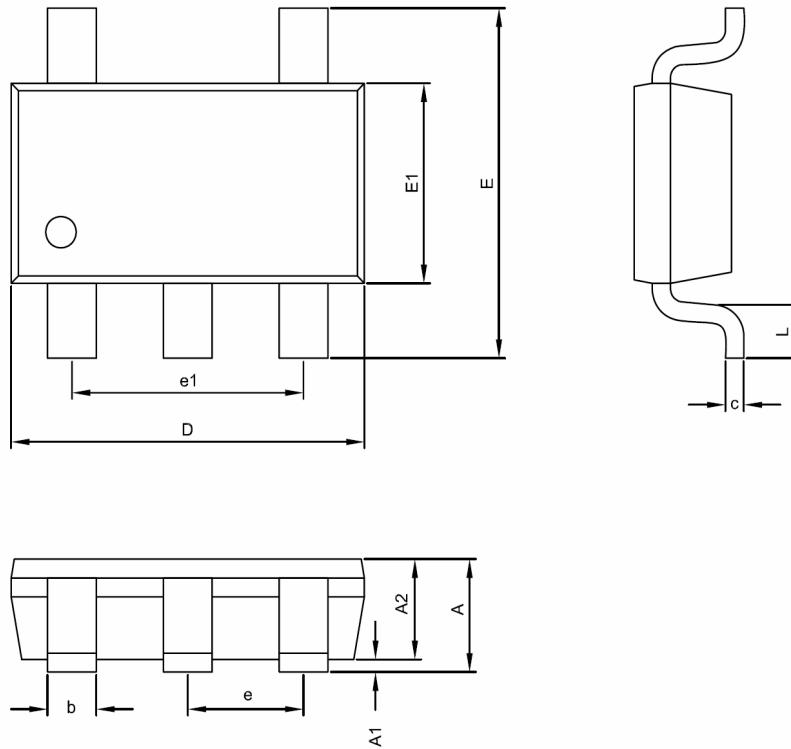

TSOT-23-5 Package

Symble	DIMENSION IN MM			DIMENSION IN INCH		
	MIN.	NOM.	MAX.	MIN.	NOM.	MAX.
A	---	---	1.00	---	---	0.039
A1	0.00	0.05	0.10	0.000	0.002	0.004
A2	0.70	0.80	0.90	0.028	0.031	0.035
D	2.70	2.90	3.10	0.106	0.114	0.122
E	2.60	2.80	3.00	0.102	0.110	0.118
E1	1.50	1.60	1.70	0.059	0.063	0.067
c	0.08	0.15	0.25	0.003	0.006	0.010
b	0.30	0.40	0.50	0.012	0.016	0.020
e	0.95 BSC			0.037 BSC		
e1	1.90 BSC			0.075 BSC		
L	0.30	0.45	0.60	0.012	0.018	0.024

Taping Specification

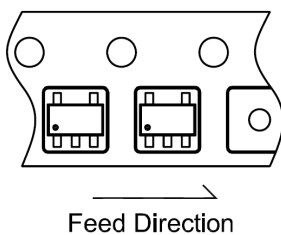

PACKAGE	Q'TY/REEL
TSOT-23-5	3,000 ea

GMT Inc. does not assume any responsibility for use of any circuitry described, no circuit patent licenses are implied and GMT Inc. reserves the right at any time without notice to change said circuitry and specifications.