

# GS2615

## 150mA Low-Noise Ultra Low-Dropout Regulator

### Product Description

The GS2615 is a 150 mA, fixed-output and adjustable voltage regulator designed to provide ultra low-dropout and low noise in battery powered applications.

Using an optimized VIP™(Vertically Integrated PNP) process, the GS2615 delivers unequalled performance in all specifications critical to battery-powered designs:

**Dropout Voltage:** Typically 300 mV @ 150 mA load, and 7 mV @ 1 mA load.

**Ground Pin Current:** Typically 850  $\mu$ A @ 150 mA load, and 75  $\mu$ A @ 1 mA load.

**Enhanced Stability:** The GS2615 is stable with output capacitor ESR as low as 5 m $\Omega$ , which allows the use of ceramic capacitors on the output.

**Sleep Mode:** Less than 1  $\mu$ A quiescent current when ON/ OFF pin is pulled low.

**Smallest Possible Size:** SOT-23-5L and micro SMD packages use absolute minimum board space.

**Precision Output:** 1% tolerance output voltages available.

**Low Noise:** By adding a 10 nF bypass capacitor, output noise can be reduced to 30  $\mu$ V (typical).

Multiple voltage options, from 2.5V to 5.0V, are available as standard products. Consult factory for custom voltages.

### Features

- Ultra low dropout voltage
- Guaranteed 150 mA output current
- Smallest possible size (SOT-23-5L, micro SMD package)
- Requires minimum external components
- Stable with low-ESR output capacitor
- <1  $\mu$ A quiescent current when shut down
- Low ground pin current at all loads
- Output voltage accuracy 1%
- High peak current capability
- Wide supply voltage range (20V max)
- Low Z<sub>OUT</sub>: 0.3 $\Omega$  typical (10 Hz to 1 MHz)
- Over temperature/over current protection
- -40°C to +125°C junction temperature range
- Custom voltages available

### Applications

- Cellular Phone
- Palmtop/Laptop Computer
- Personal Digital Assistant (PDA)
- Camcorder, Personal Stereo, Camera

### Block Diagram

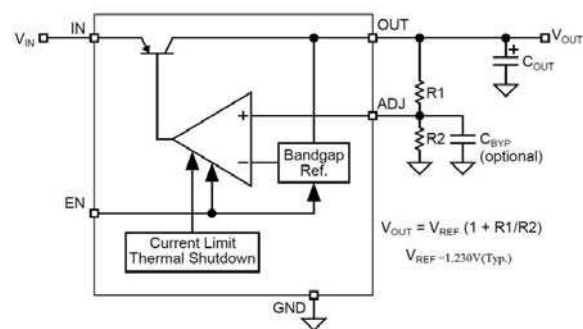
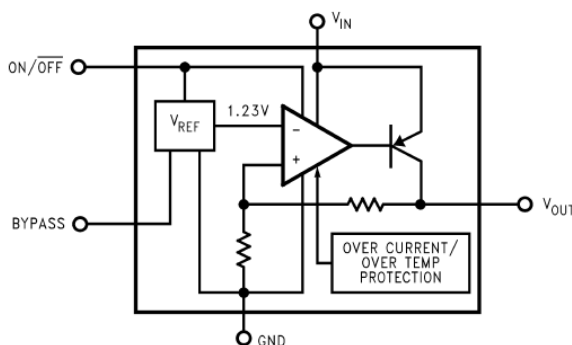

## Packages & Pin Assignments

| GS2615 (SOT-25) | GS2615-XX (FIX) Pin # | GS2615 (ADJ) Pin # | Pin Name | Pin Function   |
|-----------------|-----------------------|--------------------|----------|--|
|                 | 1                     | 1                  | IN       | Supply Input   |
|                 | 2                     | 2                  | GND      | Ground   |
|                 | 3                     | 3                  | EN       | Enable/Shutdown:<br>CMOS compatible input. Logic high = enable, logic low or open = shutdown.          |
|                 | 4                     | -                  | BYP      | Reference Bypass:<br>Connect external 470pF capacitor to GND to reduce output noise. May be left open. |
|                 | -                     | 4                  | ADJ      | Adjustable regulator feedback input. Connect to resistor voltage divider.                              |
|                 | 5                     | 5                  | OUT      | Regulator Output   |

## Ordering Information

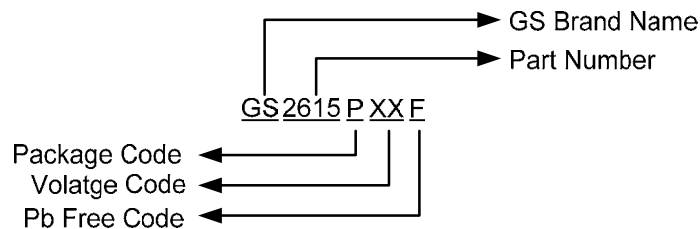

\*For other voltages, please contact factory.

## Marking Information

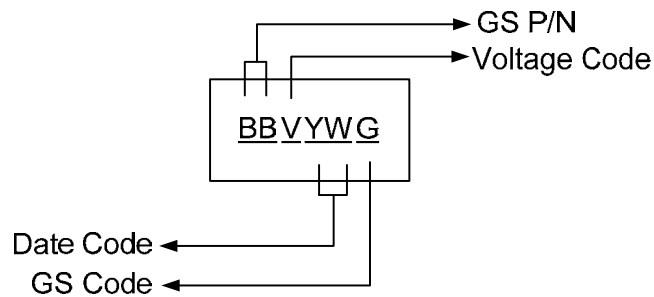

| Part Number | Marking            | Output |
|-------------|--------------------|--------|
| GS2615L     | BBA <sub>WYG</sub> | ADJ    |
| GS2615L25   | BBH <sub>WYG</sub> | 2.5V   |
| GS2615L30   | BBQ <sub>WYG</sub> | 3.0V   |
| GS2615L33   | BBR <sub>WYG</sub> | 3.3V   |
| GS2615L50   | BBV <sub>WYG</sub> | 5.0V   |

## Absolute Maximum Ratings (T<sub>A</sub>=25°C Note1)

| Symbol              | Parameter                                | Ratings                 | Units |
|---------------------|--|-------------------------|-------|
| V <sub>IN</sub>     | Input Supply Voltage (survival)          | -0.6~+20                | V     |
| V <sub>INOP</sub>   | Input Supply Voltage (operating)         | 2.5~+20                 | V     |
| ESD                 | ESD Rating (Note 2)                      | 2                       | kV    |
| P <sub>D</sub>      | Power dissipation (Note 3)               | Internally limited      |       |
| V <sub>O</sub>      | Output voltage (survival) (Note 4)       | -0.3~+9                 | V     |
| I <sub>O</sub>      | I <sub>OUT</sub> (survival)              | Short circuit protected |       |
| V <sub>IN-OUT</sub> | Input-Output voltage (survival) (Note 5) | -0.3~+20                | V     |
| T <sub>OP</sub>     | Operating Temperature                    | -40~+125                | °C    |
| T <sub>STG</sub>    | Storage Temperature                      | -65~+150                | °C    |
| T <sub>LEAD</sub>   | Lead Temp. (soldering, 5 sec.)           | 260                     | °C    |

## Electrical Characteristics(Fixed)

(unless otherwise specified: T<sub>J</sub> = 25°C. and limits in boldface type apply over the full operating temperature range. Unless otherwise specified: V<sub>IN</sub> = V<sub>O</sub>(NOM) + 1V, I<sub>L</sub> = 1 mA, C<sub>IN</sub> = 1 μF, C<sub>OUT</sub> = 4.7 μF, V<sub>ON/OFF</sub> = 2V. )

| Symbol                             | Parameter                      | Condition                                       | Min  | Typ   | Max   | Unit              |
|------------------------------------|--------------------------------|---|------|-------|-------|-------------------|
| ΔV <sub>O</sub>                    | Output voltage tolerance       | I <sub>L</sub> =1mA                             | -1.5 |       | 1.5   | %V <sub>NOM</sub> |
|                                    |                                | 1mA ≤ I <sub>L</sub> ≤ 50mA                     | -2.5 |       | 2.5   |                   |
|                                    |                                |   | -3.5 |       | 3.5   |                   |
|                                    |                                | 1mA ≤ I <sub>L</sub> ≤ 150mA                    | -3.0 |       | 3.0   |                   |
| -4.0                               |                                |   | 4.0  |       |       |                   |
| $\frac{\Delta V_O}{\Delta V_{IN}}$ | Output voltage line regulation | V <sub>O</sub> (NOM)+1V ≤ V <sub>IN</sub> ≤ 20V |      | 0.007 | 0.014 | %V                |
|                                    |                                |   |      |       | 0.032 |                   |
| V <sub>IN</sub> -V <sub>O</sub>    | Dropout voltage (Note 7)       | I <sub>L</sub> =0                               |      | 1     | 3     | mV                |
|                                    |                                | I <sub>L</sub> =1mA                             |      |       | 5     |                   |
|                                    |                                |   | 7    | 10    |       |                   |
|                                    |                                | I <sub>L</sub> =10mA                            |      | 40    | 60    |                   |
|                                    |                                |   |      |       | 90    |                   |
|                                    |                                | I <sub>L</sub> =50mA                            |      | 120   | 150   |                   |
| I <sub>L</sub> =150mA              |                                |   | 225  |       |       |                   |
|                                    | 280                            | 350   |      |       |       |                   |
| V <sub>ON/OFF</sub>                | ON/OFF input voltage (Note 8)  | High=O/P ON                                     |      | 1.4   | 1.6   | V                 |
|                                    |                                | Low=O/P OFF                                     | 0.15 | 0.55  |       |                   |
| I <sub>ON/OFF</sub>                | ON/OFF input current           | V <sub>ON/OFF</sub> =0V                         | -2   | 0.01  |       | μA                |
|                                    |                                | V <sub>ON/OFF</sub> =5V                         |      | 5     | 15    |                   |
| I <sub>GND</sub>                   | Ground pin current             | I <sub>L</sub> =0                               |      | 65    | 95    | μA                |
|                                    |                                |   |      |       | 125   |                   |
|                                    |                                | I <sub>L</sub> =1mA                             |      | 75    | 110   |                   |
|                                    |                                |   |      |       | 170   |                   |
| I <sub>L</sub> =10mA               |                                | 120   | 220  |       |       |                   |
|                                    |                                |   | 400  |       |       |                   |

## Electrical Characteristics (Fixed Continue)

(unless otherwise specified:  $T_J = 25^\circ\text{C}$ . and limits in boldface type apply over the full operating temperature range. Unless otherwise specified:  $V_{IN} = V_O(\text{NOM}) + 1\text{V}$ ,  $I_L = 1\text{mA}$ ,  $C_{IN} = 1\mu\text{F}$ ,  $C_{OUT} = 4.7\mu\text{F}$ ,  $V_{ON/OFF} = 2\text{V}$ .)

| Symbol   | Parameter                          | Condition  | Min  | Typ | Max  | Unit          |
|--|------------------------------------|--|------|-----|------|---------------|
| $I_{\text{GND}}$                                     | Ground pin current                 | $I_L = 50\text{mA}$  |      | 350 | 600  | $\mu\text{A}$ |
|  |                                    |  |      |     | 1000 |               |
|  |                                    | $I_L = 150\text{mA}$   |      | 850 | 1500 |               |
|  |                                    |  |      |     | 2500 |               |
|  | $V_{\text{ON/OFF}} < 0.3\text{V}$  |  | 0.01 | 0.8 |      |               |
|  | $V_{\text{ON/OFF}} < 0.15\text{V}$ |  | 0.05 | 2   |      |               |
| en   | Output noise voltage(RMS)          | BW=300Hz to 50kHz<br>$C_{\text{OUT}} = 10\mu\text{F}$<br>$C_{\text{BYPASS}} = 10\text{nF}$ |      | 30  |      | $\mu\text{V}$ |
| $\frac{\Delta V_{\text{OUT}}}{\Delta V_{\text{IN}}}$ | Ripple rejection                   | f=1kHz, $C_{\text{OUT}} = 10\mu\text{F}$<br>$C_{\text{BYPASS}} = 10\text{nF}$              |      | 45  |      | dB            |
| $I_{\text{O(SC)}}$                                   | Short circuit current              | $R_L = 0$ (steady state)<br><b>(Note 9)</b>  |      | 400 |      | mA            |
| $I_{\text{O(PK)}}$                                   | Peak output current                | $V_{\text{OUT}} \geq V_O(\text{NOM}) - 5\%$  |      | 350 |      | mA            |

## Electrical Characteristics (Adjustable)

| Symbol                                    | Parameter                              | Condition  | Min  | Typ   | Max   | Unit                  |
|---|--|--|------|-------|-------|-----------------------|
| $V_O$                                     | Output voltage                         | $I_L = 1\text{mA}$   | -1   | 0     | 1     | $\%V_{\text{NOM}}$    |
|   |  |  | -2   |       | 2     |                       |
| $\Delta V_O / \Delta T$                   | Output Voltage temperature Coefficient |  |      | 40    |       | ppm/ $^\circ\text{C}$ |
| $\frac{\Delta V_O}{\Delta V_{\text{IN}}}$ | Output voltage line regulation         | $V_{\text{O(NOM)}} + 1\text{V} \leq V_{\text{IN}} \leq 20\text{V}$ |      | 0.007 | 0.014 | $\%/V$                |
|   |  |  |      |       | 0.032 |                       |
| $V_{\text{IN}} - V_O$                     | Dropout voltage <b>(Note 7)</b>        | $I_L = 0$  |      | 1     | 3     | mV                    |
|   |  |  |      |       | 5     |                       |
|   |  | $I_L = 1\text{mA}$   |      | 7     | 10    |                       |
|   |  |  |      |       | 15    |                       |
|   |  | $I_L = 10\text{mA}$  |      | 40    | 60    |                       |
|   |  |  |      |       | 90    |                       |
| $I_L = 50\text{mA}$                       |  | 120  | 150  |       |       |                       |
|   |  |  | 225  |       |       |                       |
| $I_L = 150\text{mA}$                      |  | 280  | 350  |       |       |                       |
|   |  |  | 575  |       |       |                       |
| $V_{\text{ON/OFF}}$                       | ON/OFF input voltage <b>(Note 8)</b>   | High=O/P ON  |      | 1.4   | 1.6   | V                     |
|   |  | Low=O/P OFF  | 0.15 | 0.55  |       |                       |
| $I_{\text{ON/OFF}}$                       | ON/OFF input current                   | $V_{\text{ON/OFF}} = 0\text{V}$                                    | -2   | 0.01  |       | $\mu\text{A}$         |
|   |  | $V_{\text{ON/OFF}} = 5\text{V}$                                    |      | 5     | 15    |                       |
| $I_{\text{GND}}$                          | Ground pin current                     | $I_L = 0$  |      | 65    | 95    | $\mu\text{A}$         |
|   |  |  |      |       | 125   |                       |

## Electrical Characteristics (Adjustable Continue)

| Symbol                                 | Parameter                 | Condition  | Min | Typ  | Max  | Unit |
|--|---------------------------|--|-----|------|------|------|
| I <sub>GND</sub>                       | Ground pin current        | I <sub>L</sub> =1mA  |     | 75   | 110  |      |
|  |                           |  |     |      | 170  |      |
|  |                           | I <sub>L</sub> =10mA   |     | 120  | 220  |      |
|  |                           |  |     |      | 400  |      |
|  |                           | I <sub>L</sub> =50mA   |     | 350  | 600  |      |
|  |                           |  |     |      | 1000 |      |
|  |                           | I <sub>L</sub> =150mA  |     | 850  | 1500 |      |
|  |                           |  |     | 2500 |      |      |
|  |                           | V <sub>ON/OFF</sub> < 0.3V   |     | 0.01 | 0.8  |      |
|  |                           | V <sub>ON/OFF</sub> < 0.15V  |     | 0.05 | 2    |      |
| en                                     | Output noise voltage(RMS) | BW=300Hz to 50kHz<br>C <sub>OUT</sub> =10μF<br>C <sub>BYPASS</sub> =10nF |     | 50   |      | μV   |
| $\frac{\Delta V_{OUT}}{\Delta V_{IN}}$ | Ripple rejection          | f=1kHz, C <sub>OUT</sub> =10μF<br>C <sub>BYPASS</sub> =10nF              |     | 40   |      | dB   |
| I <sub>o(SC)</sub>                     | Short circuit current     | R <sub>L</sub> =0(steady state)<br><b>(Note 9)</b>                       |     | 400  |      | mA   |
| I <sub>o(PK)</sub>                     | Peak output current       | V <sub>OUT</sub> ≥ V <sub>o(NOM)</sub> -5%                               |     | 350  |      | mA   |

**Note 1:** “Absolute Maximum Ratings” indicate limits beyond which damage to the component may occur. Electrical specifications do not apply when operating the device outside of its rated operating conditions.

**Note 2:** The ESD rating of pins 3 and 4 for the SOT-23-5L package, or pins 5 and 2 for the micro SMD package, is 1 kV.

**Note 3:** The maximum allowable power dissipation is a function of the maximum junction temperature, T<sub>J</sub>(MAX), the junction-to-ambient thermal resistance, Θ<sub>J-A</sub>, and the ambient temperature, T<sub>A</sub>. The maximum allowable power dissipation at any ambient temperature is calculated using:

$$P(\text{MAX}) = \frac{T_J(\text{MAX}) - T_A}{\Theta_{J-A}}$$

Where the value of Θ<sub>J-A</sub> for the SOT-23-5L package is 220°C/W in a typical PC board mounting and the micro SMD package is 225°C/W. Exceeding the maximum allowable dissipation will cause excessive die temperature, and the regulator will go into thermal shutdown.

**Note 4:** If used in a dual-supply system where the regulator load is returned to a negative supply, the GS2615 output must be diode-clamped to ground.

**Note 5:** The output PNP structure contains a diode between the V<sub>IN</sub> to V<sub>OUT</sub> terminals that is normally reverse-biased. Reversing the polarity from V<sub>IN</sub> to V<sub>OUT</sub> will turn on this diode.

**Note 6:** Limits are 100% production tested at 25°C. Limits over the operating temperature range are guaranteed through correlation using Statistical Quality Control (SQC) methods. The limits are used to calculate National’s Average Outgoing Quality Level (AOQL).

**Note 7:** Dropout voltage is defined as the input to output differential at which the output voltage drops 100 mV below the value measured with a 1V differential.

**Note 8:** The ON/OFF input must be properly driven to prevent possible mis-operation. For details, refer to Application Hints.

**Note 9:** The GS2615 has foldback current limiting which allows a high peak current when V<sub>OUT</sub> > 0.5V, and then reduces the maximum output current as V<sub>OUT</sub> is forced to ground (see Typical Performance Characteristics curves).

**Note 10:** Exposing the micro SMD device to direct sunlight will cause mis-operation. See Application Hints for additional information.

## Application Summary

### EXTERNAL CAPACITORS

Like any low-dropout regulator, the GS2615 requires external capacitors for regulator stability. These capacitors must be correctly selected for good performance.

#### Input Capacitor

An input capacitor whose capacitance is  $\geq 1 \mu\text{F}$  is required between the GS2615 input and ground (the amount of capacitance may be increased without limit). This capacitor must be located a distance of not more than 1 cm from the input pin and returned to a clean analog ground. Any good quality ceramic, tantalum, or film capacitor may be used at the input.

**Important:** Tantalum capacitors can suffer catastrophic failure due to surge current when connected to a low impedance source of power (like a battery or very large capacitor). If a Tantalum capacitor is used at the input, it must be guaranteed by the manufacturer to have a surge current rating sufficient for the application.

There are no requirements for ESR on the input capacitor, but tolerance and temperature coefficient must be considered when selecting the capacitor to ensure the capacitance will be  $\geq 1 \mu\text{F}$  over the entire operating temperature range.

#### Output Capacitor

The GS2615 is designed specifically to work with ceramic output capacitors, utilizing circuitry which allows the regulator to be stable across the entire range of output current with an output capacitor whose ESR is as low as 5 m $\Omega$ . It may also be possible to use.

Tantalum or film capacitors at the output, but these are not as attractive for reasons of size and cost (see next section Capacitor Characteristics). The output capacitor must meet the requirement for minimum amount of capacitance and also have an ESR (equivalent series resistance) value which is within the stable range. Curves are provided which show the stable ESR range as a function of load current (see ESR graph below).

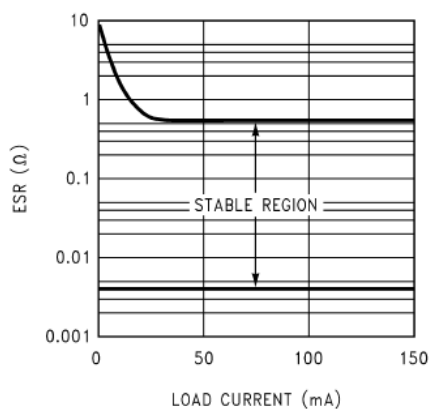

**Important:** The output capacitor must maintain its ESR within the stable region over the full operating temperature range of the application to assure stability.

The GS2615 requires a minimum of 2.2  $\mu\text{F}$  on the output (output capacitor size can be increased without limit).

It is important to remember that capacitor tolerance and variation with temperature must be taken into consideration when selecting an output capacitor so that the minimum required amount of output capacitance is provided over the full operating temperature range. It should be noted that ceramic capacitors can exhibit large changes in capacitance with temperature (see next section, *Capacitor Characteristics*).

The output capacitor must be located not more than 1 cm from the output pin and returned to a clean analog ground.

#### Noise Bypass Capacitor

Connecting a 10 nF capacitor to the Bypass pin significantly reduces noise on the regulator output. It should be noted that the capacitor is connected directly to a high-impedance circuit in the band gap reference.

Because this circuit has only a few microamperes flowing in it, any significant loading on this node will cause a change in the regulated output voltage. For this reason, DC leakage current through the noise bypass capacitor

must never exceed 100 nA, and should be kept as low as possible for best output voltage accuracy.

The types of capacitors best suited for the noise bypass capacitor are ceramic and film. High-quality ceramic capacitors with either NPO or COG dielectric typically have very low leakage. 10 nF polypropylene and polycarbonate film capacitors are available in small surface-mount packages and typically have extremely low leakage current.

### Adjustable Regulator Applications

The GS2615 can be adjusted to a specific output voltage by using two external resistors (see Application circuit). The resistors set the output voltage based on the following equation:

$$\Delta V_{OUT} = 1.230V \times \left( \frac{R1}{R2} + 1 \right)$$

This equation is correct due to the configuration of the bandgap reference. The bandgap voltage is relative to the output, as seen in the block diagram. Traditional regulators normally have the reference voltage relative to ground and have a different V<sub>OUT</sub> equation. Resistor values are not critical because ADJ (adjust) has a high input impedance, but for best results use resistors of 470kΩ or less. A capacitor from ADJ to ground provides greatly improved noise performance.

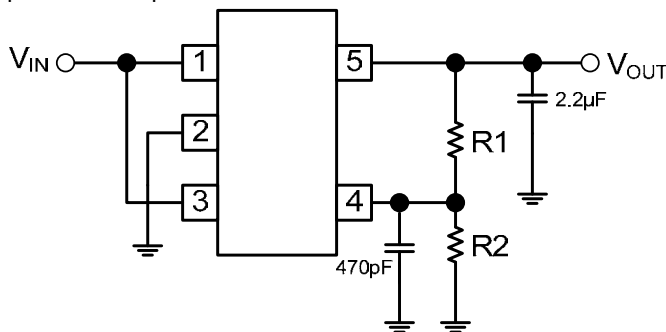

$$\Delta V_{OUT} = 1.230V \times \left( \frac{R1}{R2} + 1 \right)$$

470pF noise bypass capacitor from ADJ to GND to reduce output noise.

Application Circuit

### CAPACITOR CHARACTERISTICS

The GS2615 was designed to work with ceramic capacitors on the output to take advantage of the benefits they offer: for capacitance values in the 2.2 µF to 4.7 µF range, ceramics are the least expensive and also have the lowest ESR values (which makes them best for eliminating high frequency noise). The ESR of a typical 2.2 µF ceramic capacitor is in the range of 10 mΩ to 20 mΩ, which easily meets the ESR limits required for stability by the GS2615. One disadvantage of ceramic capacitors is that their capacitance can vary with temperature. Most large value ceramic capacitors (≥ 2.2 µF) are manufactured with the Z5U or Y5V temperature characteristic, which results in the capacitance dropping by more than 50% as the temperature goes from 25°C to 85°C.

This could cause problems if a 2.2 µF capacitor were used on the output since it will drop down to approximately 1 µF at high ambient temperatures (which could cause the GS2615 to oscillate). If Z5U or Y5V capacitors are used on the output, a minimum capacitance value of 4.7 µF must be observed.

A better choice for temperature coefficient in ceramic capacitors is X7R, which holds the capacitance within ±15%. Unfortunately, the larger values of capacitance are not offered by all manufacturers in the X7R dielectric.

### Tantalum

Tantalum capacitors are less desirable than ceramics for use as output capacitors because they are more expensive when comparing equivalent capacitance and voltage ratings in the 1 µF to 4.7 µF range.

Another important consideration is that Tantalum capacitors have higher ESR values than equivalent size ceramics. This means that while it may be possible to find a Tantalum capacitor with an ESR value within the stable range, it would have to be larger in capacitance (which means bigger and more costly) than a ceramic capacitor with the same. It should also be noted that the ESR of a typical Tantalum will increase about 2:1 as the temperature goes from 25°C down to -40°C, so some guard band must be allowed.



## On/off Input Operation

The GS2615 is shut off by driving the ON/OFF input low, and turned on by pulling it high. If this feature is not to be used, the ON/OFF input should be tied to  $V_{IN}$  to keep the regulator output on at all times.

To assure proper operation, the signal source used to drive the ON/OFF input must be able to swing above and below the specified turn-on/turn-off voltage thresholds listed in the Electrical Characteristics section under  $V_{ON/OFF}$ . To prevent mis-operation, the turn-on (and turn-off) voltage signals applied to the ON/OFF input must have a slew rate which is  $\geq 40$  mV/ $\mu$ s.

**Caution:** the regulator output voltage can not be guaranteed if a slow-moving AC (or DC) signal is applied that is in the range between the specified turn-on and turn-off voltages listed under the electrical specification  $V_{ON/OFF}$  (see Electrical Characteristics).

## REVERSE INPUT-OUTPUT VOLTAGE

The PNP power transistor used as the pass element in the GS2615 has an inherent diode connected between the regulator output and input. During normal operation (where the input voltage is higher than the output) this diode is reverse biased.

However, if the output is pulled above the input, this diode will turn ON and current will flow into the regulator output. In such cases, a parasitic SCR can latch which will allow a high current to flow into  $V_{IN}$  (and out the ground pin), which can damage the part.

In any application where the output may be pulled above the input, an external schottky diode must be connected from  $V_{IN}$  to  $V_{OUT}$  (cathode on  $V_{IN}$ , anode on  $V_{OUT}$ ), to limit the reverse voltage across the GS2615 to 0.3V (see Absolute Maximum Ratings).

## MICRO SMD MOUNTING

The micro SMD package requires specific mounting techniques which are detailed in National Semiconductor Application Note # 1112. Referring to the section **Surface Mount Technology (SMT) Assembly Considerations**, it should be noted that the pad style which must be used with the 5-pin package is the NSMD (non-solder mask defined) type.

For best results during assembly, alignment ordinals on the PC board may be used to facilitate placement of the micro SMD device.

## MICRO SMD LIGHT SENSITIVITY

Exposing the micro SMD device to direct sunlight will cause mis-operation of the device. Light sources such as Halogen lamps can also affect electrical performance if brought near to the device.

The wave lengths which have the most detrimental effect are reds and infra-reds, which mean that the fluorescent lighting used inside most buildings has very little effect on performance. A micro SMD test board was brought to within 1 cm of a fluorescent desk lamp and the effect on the regulated output voltage was negligible, showing a deviation of less than 0.1% from nominal.

## Application Current

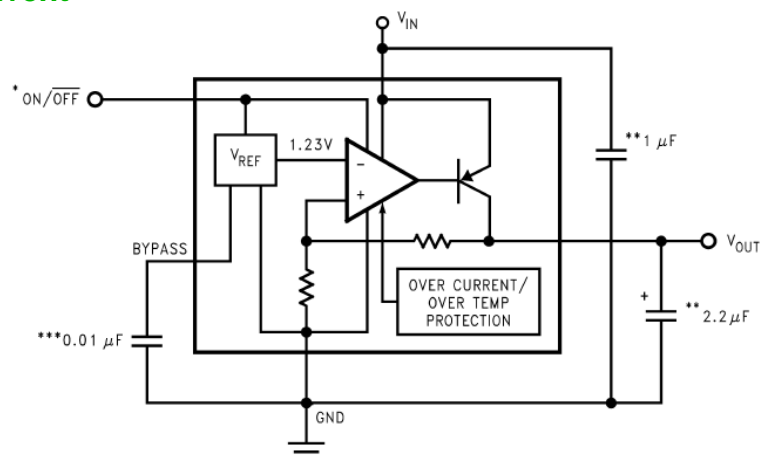

\*ON/OFF input must be actively terminated. Tie to  $V_{IN}$  if this function is not to be used.

\*\*Minimum capacitance is shown to ensure stability (may be increased without limit). Ceramic capacitor required for output

\*\*\*Reduces output noise (may be omitted if application is not noise critical). Use ceramic or film type with very low leakage current



## Typical Performance Characteristics

Unless otherwise specified:  $C_{IN} = 1\mu F$ ,  $C_{OUT} = 4.7\mu F$ ,  $V_{IN} = V_{OUT(NOM)} + 1$ ,  $T_A = 25^\circ C$ , ON/OFF pin is tied to  $V_{IN}$ .

### $V_{OUT}$ vs Temperature

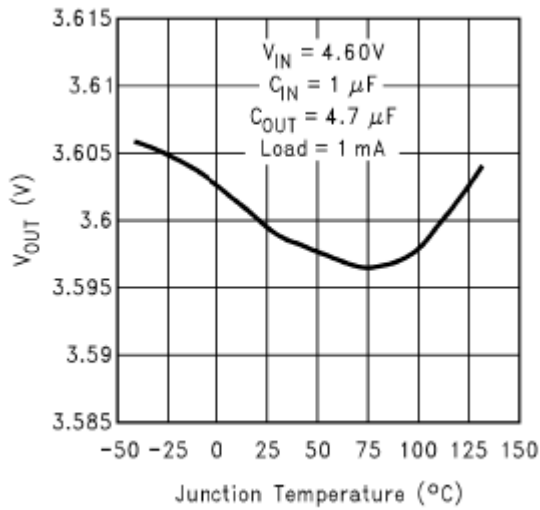

### Short-Circuit Current

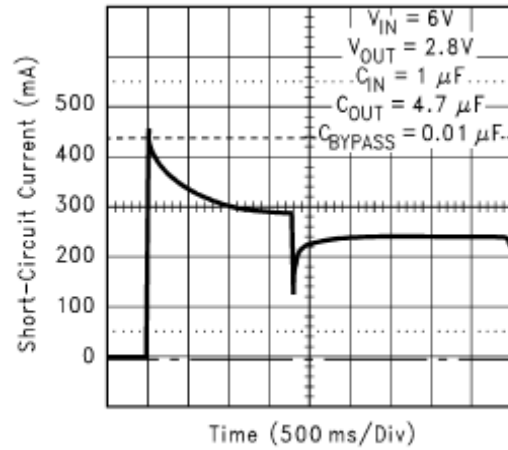

### Short-Circuit Current

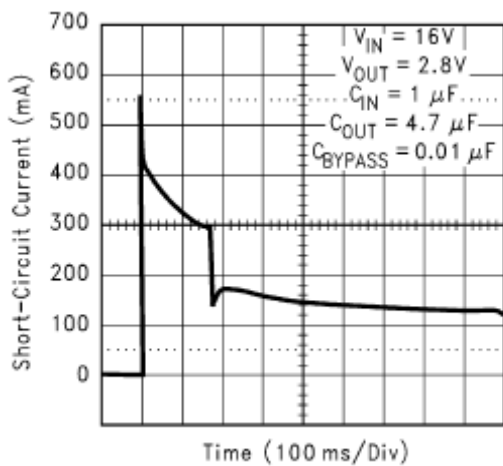

### Short Circuit Current vs Output Voltage

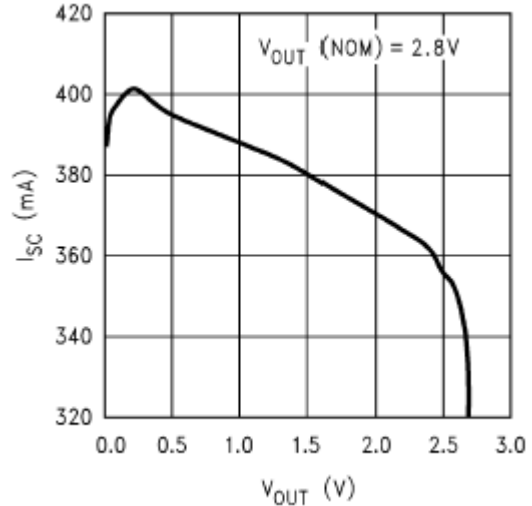

### Ripple Rejection

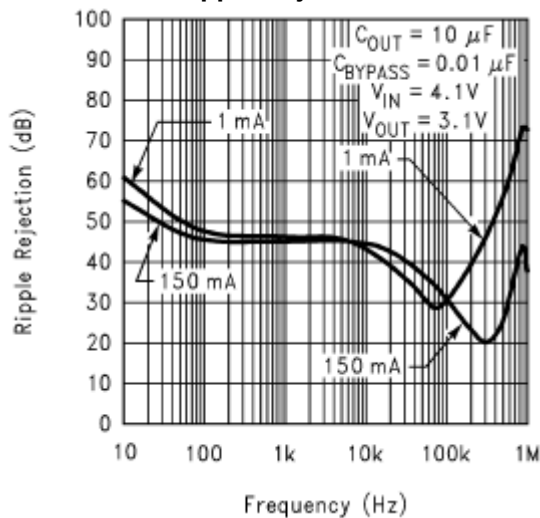

### Ripple Rejection

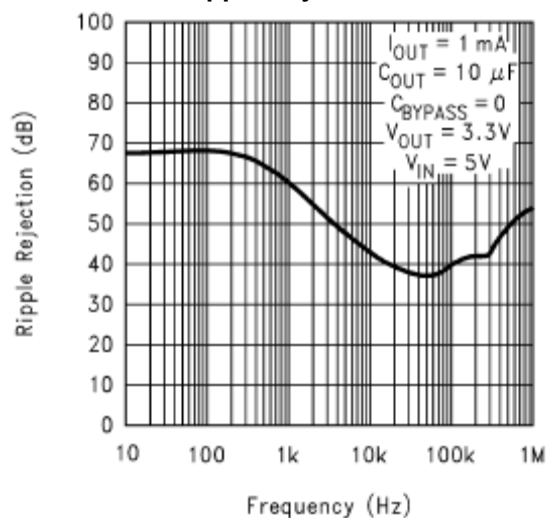

## Typical Performance Characteristics(Continue)

### Ripple Rejection

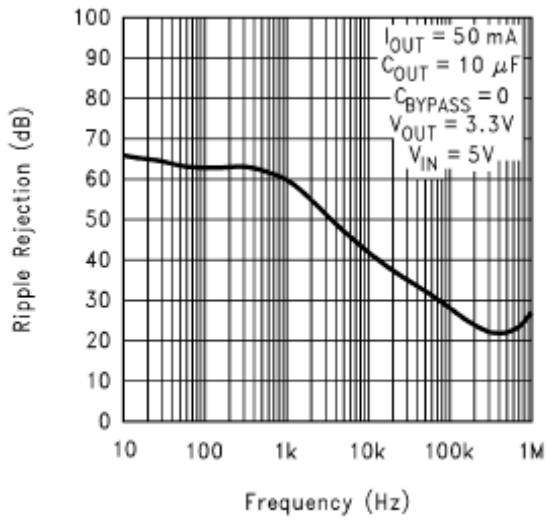

### Ripple Rejection

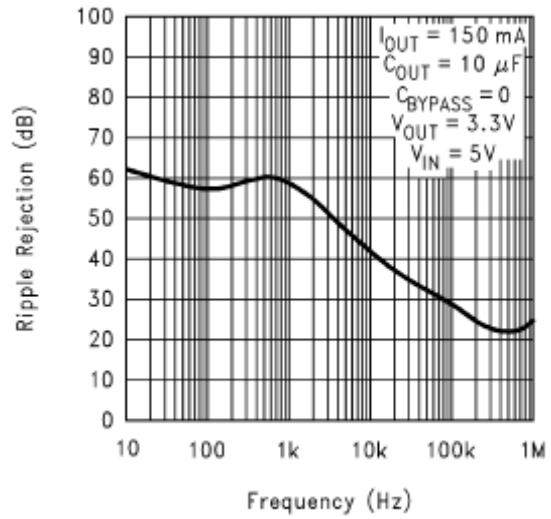

### Ripple Rejection

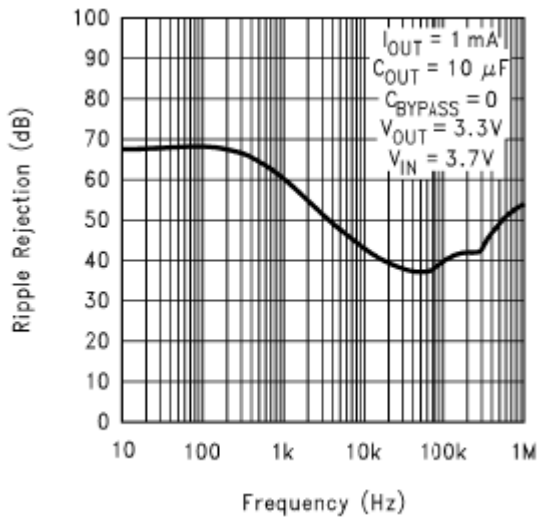

### Ripple Rejection

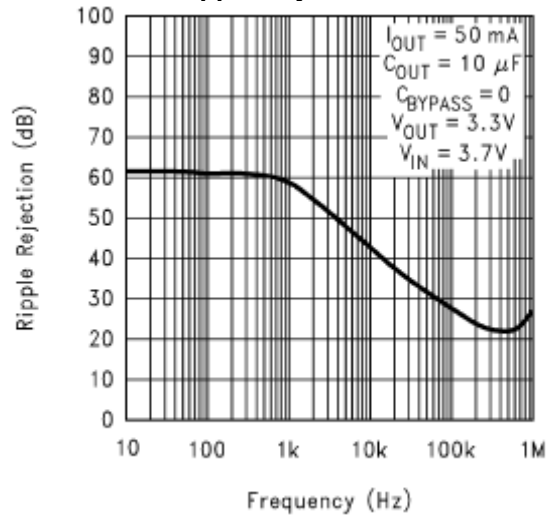

### Ripple Rejection

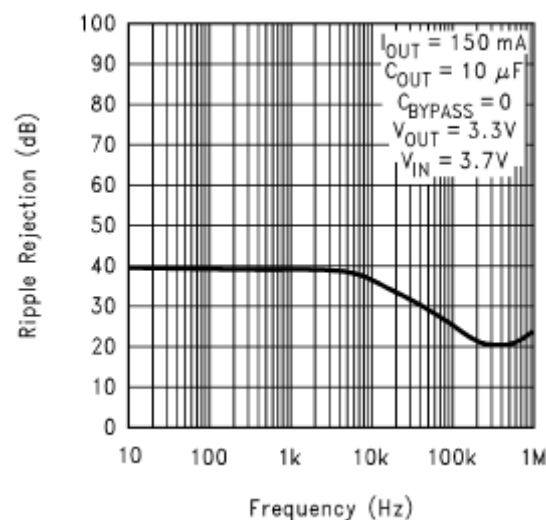

### Ripple Rejection

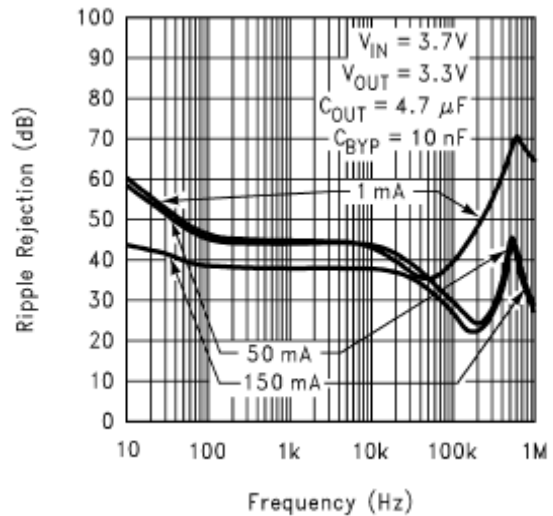

## Typical Performance Characteristics(Continue)

### Ripple Rejection

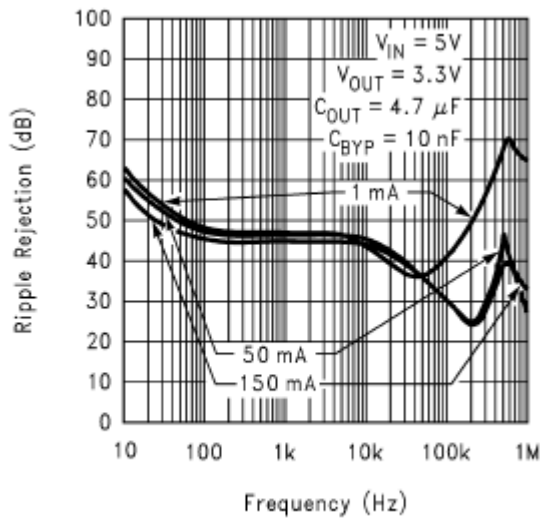

### Output Impedance vs Frequency

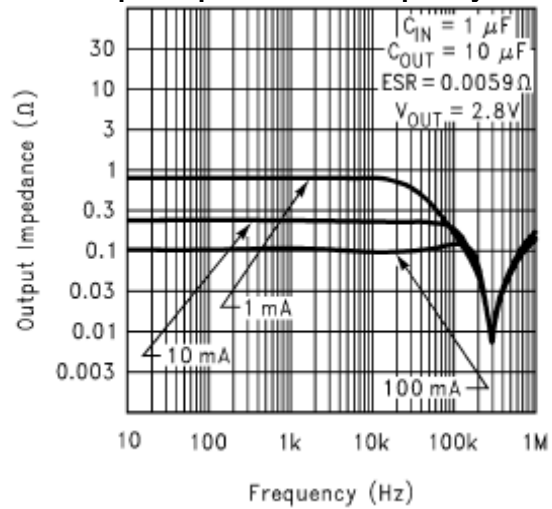

### Output Impedance vs Frequency

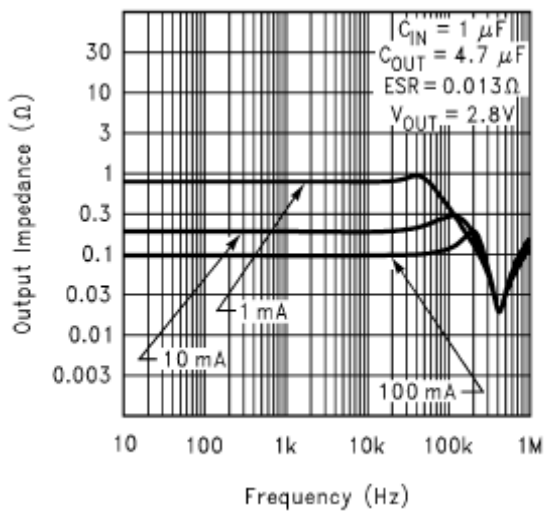

### Output Noise Density

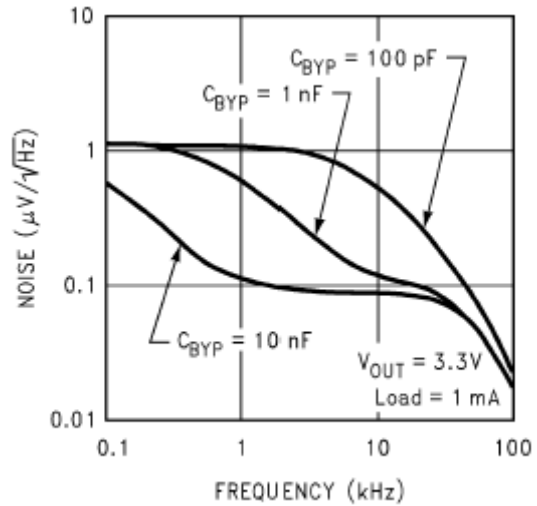

### Output Noise Density

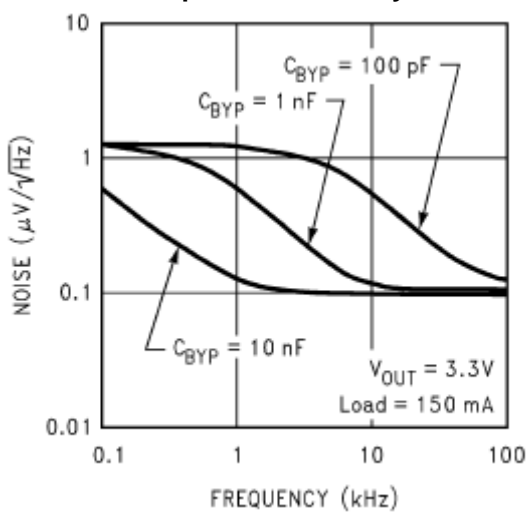

### Ground Pin vs Load Current

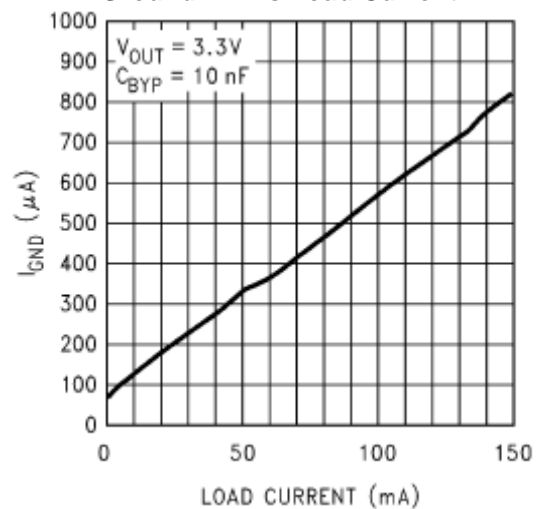

## Typical Performance Characteristics(Continue)

### Dropout Voltage vs Temperature

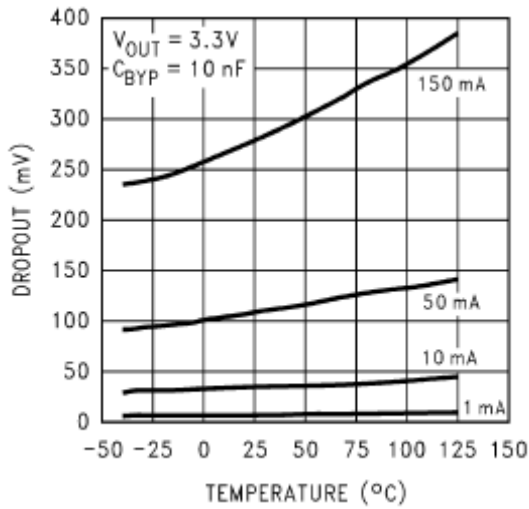

### Input Current vs Pin

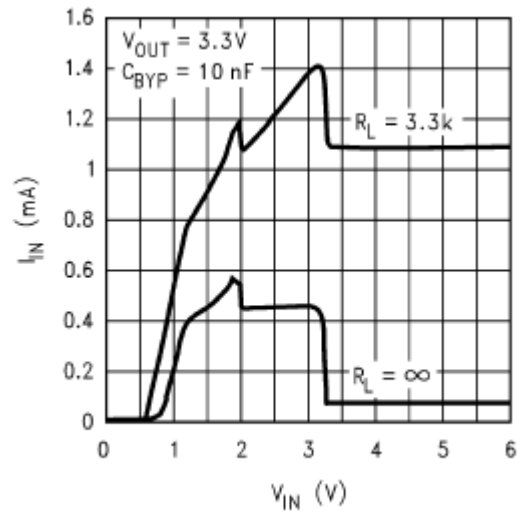

### GND Pin Current vs Temperature

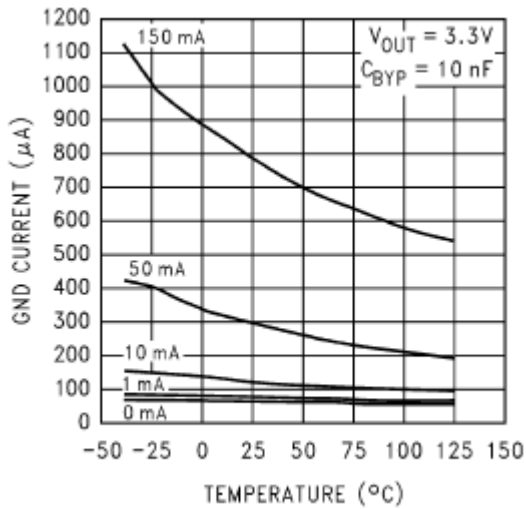

### Instantaneous Short Circuit Current

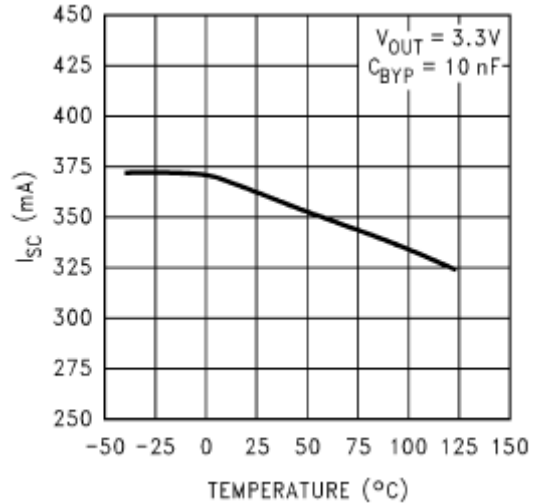

### Load Transient Response

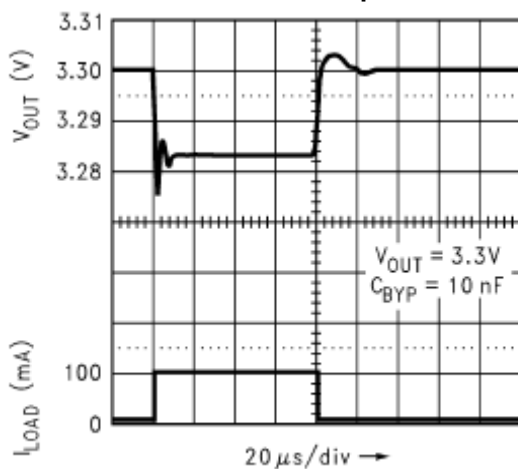

### Load Transient Response

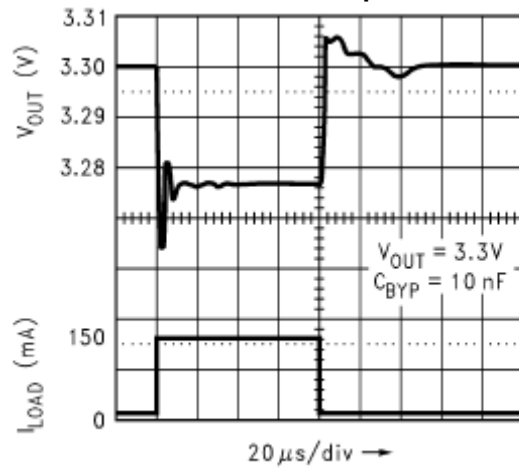

## Typical Performance Characteristics(Continue)

### Load Transient Response

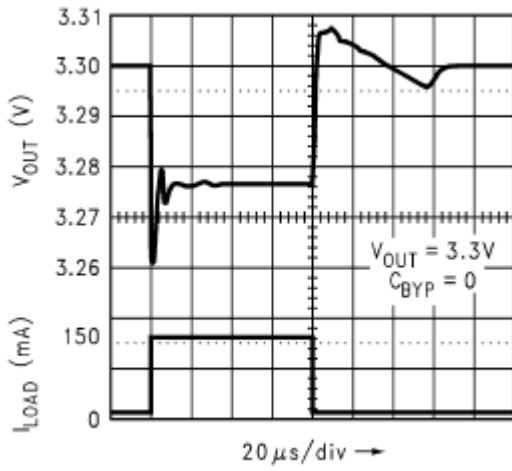

### Line Transient Response

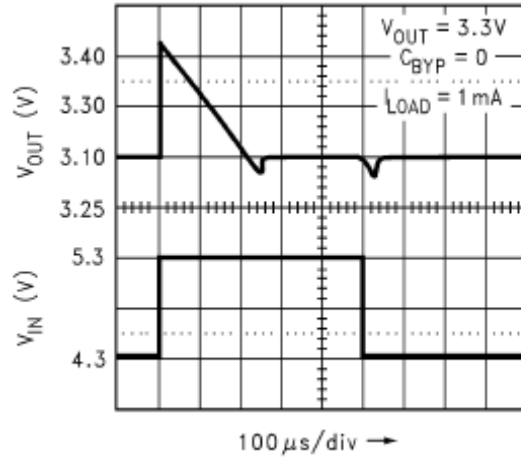

### Line Transient Response

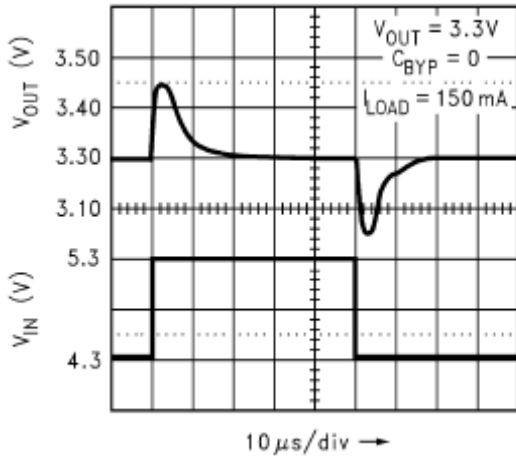

### Line Transient Response

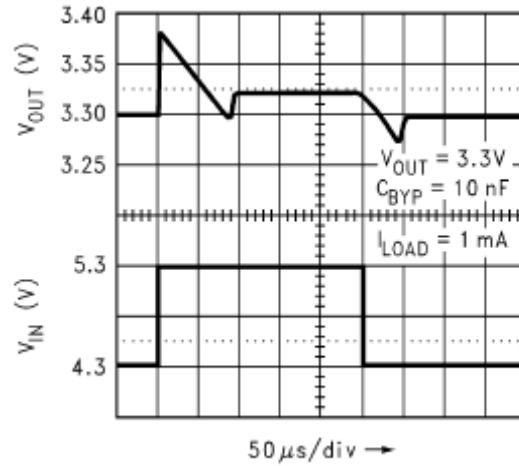

### Line Transient Response

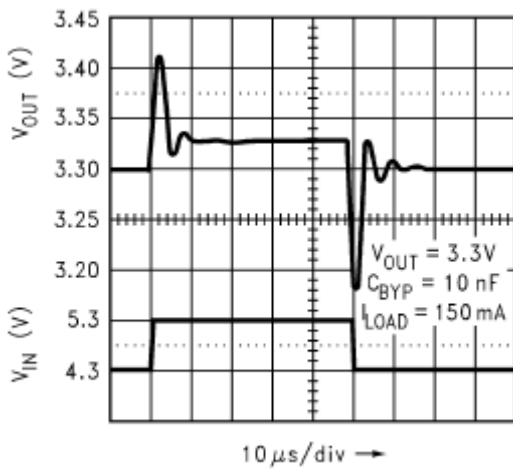

### Turn-On Time

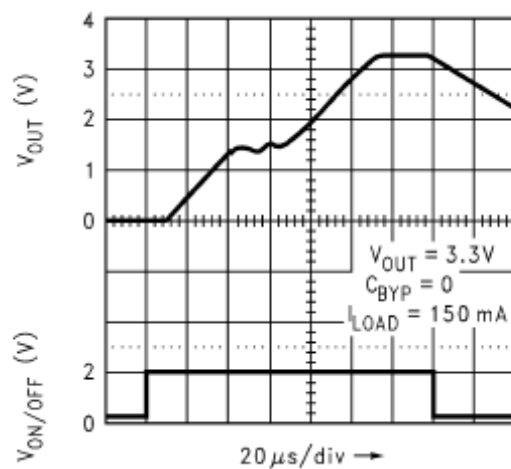

## Typical Performance Characteristics(Continue)

### Turn-On Time

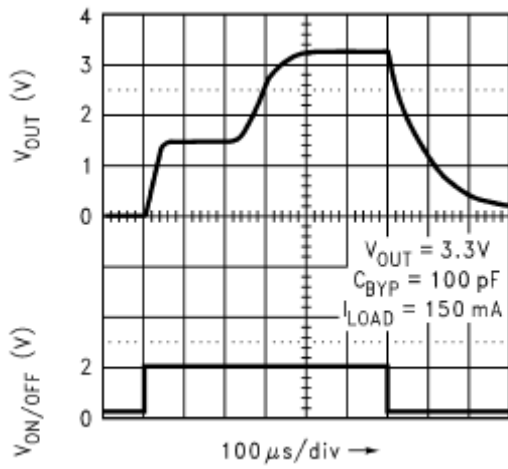

### Turn-On Time

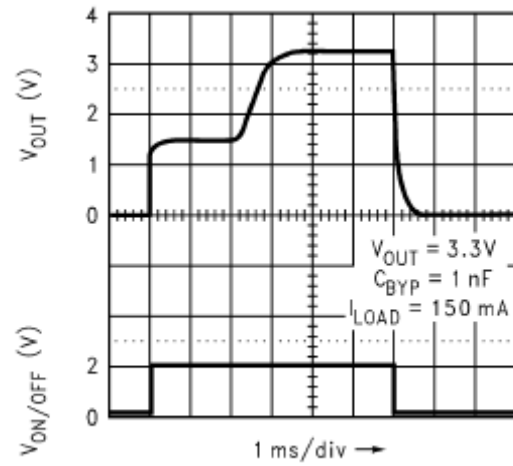

### Turn-On Time

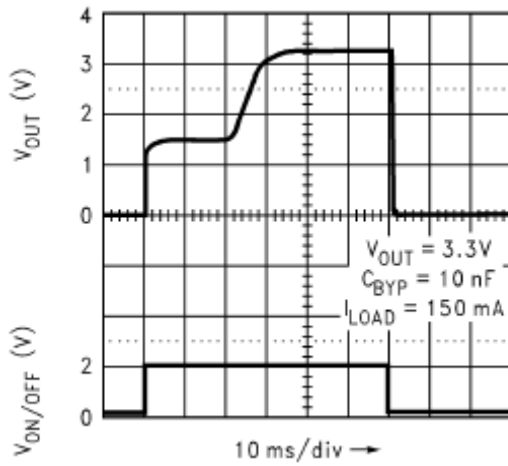

## Package Dimension

### SOT-23-5L PLASTIC PACKAGE

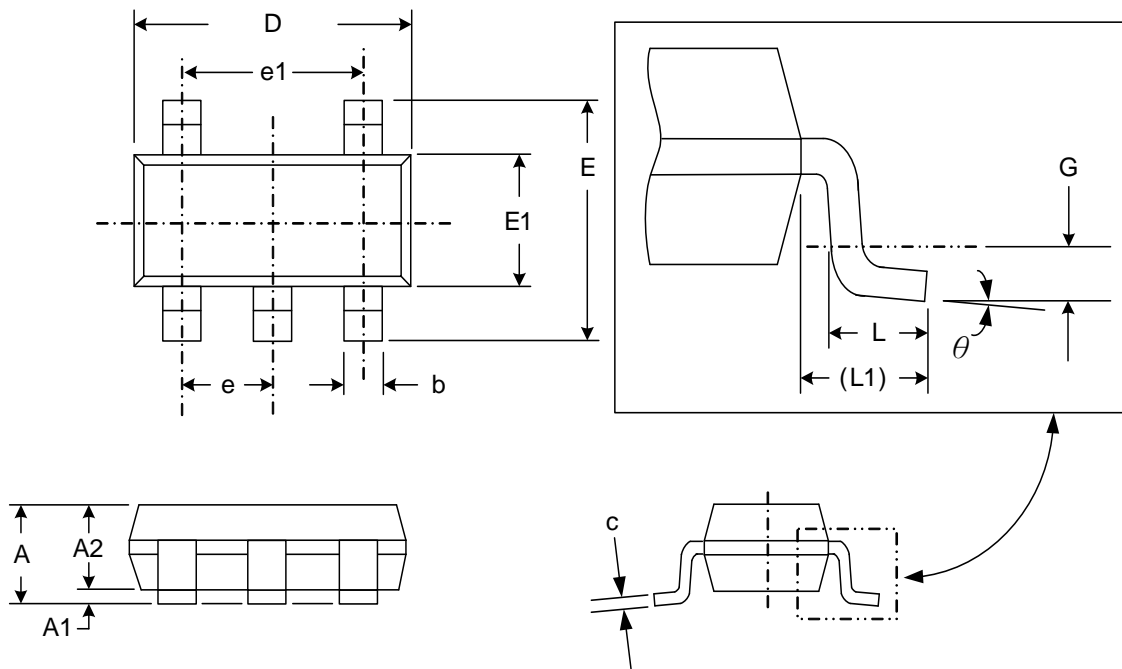





| Dimensions                 |             |      |            |      |
|----------------------------|-------------|------|------------|------|
| SYMBOL                     | Millimeters |      | Inches     |      |
|                            | MIN         | MAX  | MIN        | MAX  |
| <b>A</b>                   | 0.95        | 1.45 | .037       | .057 |
| <b>A1</b>                  | 0.05        | 0.15 | .002       | .006 |
| <b>A2</b>                  | 0.90        | 1.30 | .035       | .051 |
| <b>b</b>                   | 0.30        | 0.50 | .012       | .020 |
| <b>c</b>                   | 0.08        | 0.20 | .003       | .008 |
| <b>D</b>                   | 2.80        | 3.00 | .110       | .118 |
| <b>E</b>                   | 2.60        | 3.00 | .102       | .118 |
| <b>E1</b>                  | 1.50        | 1.70 | .059       | .067 |
| <b>e</b>                   | 0.95 (TYP)  |      | .037 (TYP) |      |
| <b>e1</b>                  | 1.90 (TYP)  |      | .075 (TYP) |      |
| <b>L</b>                   | 0.35        | 0.55 | .014       | .022 |
| <b>L1</b>                  | 0.60 (TYP)  |      | .024 (TYP) |      |
| <b>G</b>                   | 0.25 (TYP)  |      | .010 (TYP) |      |
| <b><math>\theta</math></b> | 0°          | 8°   | 0°         | 8°   |





## NOTICE

Information furnished is believed to be accurate and reliable. However Globaltech Semiconductor assumes no responsibility for the consequences of use of such information nor for any infringement of patents or other rights of third parties, which may result from its use. No license is granted by implication or otherwise under any patent or patent rights of Globaltech Semiconductor. Specifications mentioned in this publication are subject to change without notice. This publication supersedes and replaces all information without express written approval of Globaltech Semiconductor.

## CONTACT US

| GS Headquarter  |   |
|---|---|
|  | 4F.,No.43-1,Lane11,Sec.6,Minquan E. Rd Neihu District Taipei City 114, Taiwan (R.O.C) |
|  | 886-2-2657-9980   |
|  | 886-2-2657-3630   |
|  | sales_twn@gs-power.com  |

| Wu-Xi Branch  |  |
|---|--|
|  | No.21 Changjiang Rd., WND, Wuxi, Jiangsu, China (INFO. & TECH. Science Park Building A 210 Room) |
|  | 86-510-85217051  |
|  | 86-510-85211238  |
|  | sales_cn@gs-power.com  |

| RD Division   |                                      |
|---|--------------------------------------|
|  | 824 Bolton Drive Milpitas. CA. 95035 |
|  | 1-408-457-0587                       |