



MIC94090/1/2/3/4/5

High Side Load Switches for Consumer Applications

General Description

The MIC94090/1/2/3/4/5 is a family of high-side load switches designed for operation from 1.7V to 5.5V input voltage. The load switch pass element is an internal 130mΩ $R_{DS(ON)}$ P-channel MOSFET which enables the device to support up to 1.2A continuous current. Additionally, the load switch supports 1.5V logic level control and shutdown features.

The MIC94090 and MIC94091 feature rapid turn on. The MIC94092 and MIC94093 provide a slew rate controlled soft-start turn-on of 790μs, while the MIC94094 and MIC94095 provide a slew rate controlled soft-start turn-on of 120μs. The soft-start feature option prevents an in-rush current event from pulling down the input supply voltage.

The MIC94091, MIC94093, and MIC94095 include a 250Ω auto discharge load circuit that is switched on when the load switch is disabled.

An active pull-down on the enable input keeps the MIC94090/1/2/3/4/5 in a default OFF state until the enable pin is pulled above 1.25V. Internal level shift circuitry allows low voltage logic signals to switch higher supply voltages. The enable voltage can be as high as 5.5V and is not limited by the input voltage.

The MIC94090/1/2/3/4/5 operating voltage range makes them ideal for Lithium ion and NiMH/NiCad/Alkaline battery powered systems, as well as non-battery powered applications. The devices provide low quiescent current and low shutdown current to maximize battery life.

Datasheets and support documentation can be found on Micrel's web site at: www.micrel.com.

Features

- 1.7V to 5.5V input voltage range
- 1.2A continuous operating current
- 130mΩ $R_{DS(ON)}$
- Internal level shift for CMOS/TTL control logic
- Ultra low quiescent current
- Micro-power shutdown current
- Rapid turn-on: MIC94090/1
- Soft-Start: MIC94092/3 (790μs), MIC94094/5 (120μs)
- Load discharge circuit: MIC94091/3/5
- Space saving and thermally capable 1.2mm x 1.2mm Thin MLF[®] package
- Industry standard SC-70-6 package

Applications

- Cellular phones
- Portable Navigation Devices (PND)
- GPS modules
- Personal Media Players (PMP)
- Ultra Mobile PCs
- Other Portable applications
- PDAs
- Portable instrumentation
- Industrial and DataComm equipment

Typical Application

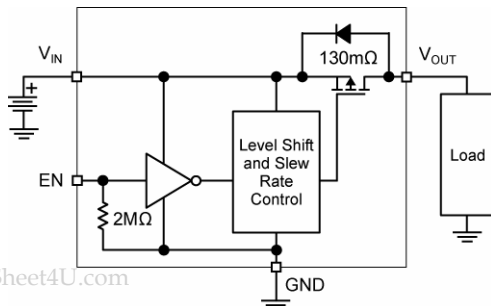

MIC94090 (ultra fast turn on)
MIC94092 (790μs soft-start)
MIC94094 (120μs soft-start)

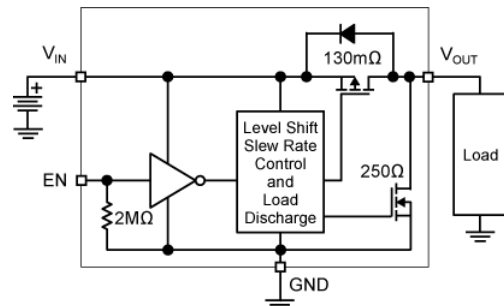

MIC94091 (ultra fast turn on with auto-discharge)
MIC94093 (790μs soft-start with auto-discharge)
MIC94095 (120μs soft-start with auto-discharge)

MLF and MicroLeadFrame are registered trademarks of Amkor Technology, Inc.

Micrel Inc. • 2180 Fortune Drive • San Jose, CA 95131 • USA • tel +1 (408) 944-0800 • fax +1 (408) 474-1000 • <http://www.micrel.com>

Ordering Information

Part Number Pb-Free	Part Marking Pb-Free ⁽¹⁾	Fast Turn On	Soft-Start	Load Discharge	Package ^{(2) (3)}
MIC94090YMT	D1	•			4-Pin 1.2mm x 1.2mm Thin MLF [®]
MIC94091YMT	D2	•		•	4-Pin 1.2mm x 1.2mm Thin MLF [®]
MIC94092YMT	D5		790µs		4-Pin 1.2mm x 1.2mm Thin MLF [®]
MIC94093YMT	D7		790µs	•	4-Pin 1.2mm x 1.2mm Thin MLF [®]
MIC94094YMT	0D		120µs		4-Pin 1.2mm x 1.2mm Thin MLF [®]
MIC94095YMT	1D		120µs	•	4-Pin 1.2mm x 1.2mm Thin MLF [®]
MIC94090YC6	<u>D</u> 1D	•			SC-70-6
MIC94091YC6	<u>D</u> 2D	•		•	SC-70-6
MIC94092YC6	<u>D</u> 5D		790µs		SC-70-6
MIC94093YC6	<u>D</u> 7D		790µs	•	SC-70-6
MIC94094YC6	<u>0</u> DD		120µs		SC-70-6
MIC94095YC6	<u>1</u> DD		120µs	•	SC-70-6

Notes:

- Under bar symbol () may not be to scale.
- Thin MLF[®] ▲ = Pin 1 identifier.
- Thin MLF[®] is a GREEN RoHS-compliant package. Lead finish is NiPdAu. Mold compound is Halogen Free.

Pin Configuration

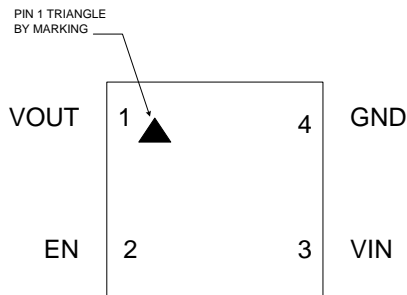

4-Pin (1.2mm x 1.2mm) Thin MLF[®] (MT)
Top View

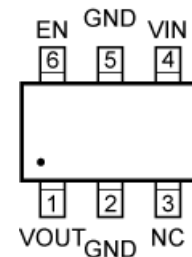

6-Pin SC-70-6 (C6)
Top View

Pin Description

Pin Number		Pin Name	Pin Function
TMLF-4	SC-70-6		
1	1	V _{OUT}	Drain of P-Channel MOSFET.
4	2, 5	GND	Ground: Connect to electrical ground.
3	4	V _{IN}	Source of P-Channel MOSFET.
2	6	EN	Enable (Input): Active-high CMOS-compatible control input for switch. Internal 2MΩ pull down resistor to GND, output will be off if this pin is left floating.
--	3	NC	No Internal Connection. A signal or voltage applied to this pin will have no effect on device operation.

Absolute Maximum Ratings⁽¹⁾

Input Voltage (V_{IN})	+6V
Enable Voltage (V_{EN})	+6V
Continuous Drain Current (I_D) ⁽³⁾	
$T_A = 25^\circ\text{C}$ (MLF [®])	$\pm 1.2\text{A}$
$T_A = 25^\circ\text{C}$ (SC-70)	$\pm 1.2\text{A}$
Pulsed Drain Current (I_{DP}) ⁽⁴⁾	$\pm 6.0\text{A}$
Continuous Diode Current (I_S) ⁽⁵⁾	-50mA
Storage Temperature (T_S)	-55°C to +150°C
ESD Rating – HBM ⁽⁶⁾	3kV

Operating Ratings⁽²⁾

Input Voltage (V_{IN})	+1.7 to +5.5V
Junction Temperature (T_J)	-40°C to +125°C
Package Thermal Resistance	
Thin MLF [®] (θ_{JC}) ⁽³⁾	60°C/W
Thin MLF [®] (θ_{JA}) ⁽³⁾	140°C/W
SC-70-6 (θ_{JC})	100°C/W
SC-70-6 (θ_{JA})	240°C/W

Electrical Characteristics

$T_A = 25^\circ\text{C}$, bold values indicate $-40^\circ\text{C} \leq T_A \leq +85^\circ\text{C}$, unless noted.

Symbol	Parameter	Condition	Min	Typ	Max	Units
V_{EN_TH}	Enable Threshold Voltage	$V_{IN} = 1.7\text{V}$ to 4.5V , $I_D = -250\mu\text{A}$	0.4		1.25	V
I_Q	Quiescent Current Measured on the V_{IN} Pin	$V_{IN} = V_{EN} = 5.5\text{V}$, $I_D = \text{OPEN}$ Measured on V_{IN} MIC94090/1		0.1	1	μA
		$V_{IN} = V_{EN} = 5.5\text{V}$, $I_D = \text{OPEN}$ Measured on V_{IN} MIC94092/3/4/5		8	15	μA
I_{EN}	Enable Input Current	$V_{IN} = V_{EN} = 5.5\text{V}$, $I_D = \text{OPEN}$		2.5	4	μA
I_{SD}	Shutdown Current	$V_{IN} = +5.5\text{V}$, $V_{EN} = 0\text{V}$, $I_D = \text{OPEN}$ Measured on the V_{IN} pin ⁽⁷⁾		0.01	1	μA
$I_{SHUT-SWITCH}$	OFF State Leakage Current	$V_{IN} = +5.5\text{V}$, $V_{EN} = 0\text{V}$, $I_D = \text{SHORT}$ Measured on V_{OUT} ⁽⁷⁾		0.01	1	μA
$R_{DS(ON)}$	P-Channel Drain to Source ON Resistance	$V_{IN} = +5.0\text{V}$, $I_D = -100\text{mA}$, $V_{EN} = 1.5\text{V}$		130	225	m Ω
		$V_{IN} = +4.5\text{V}$, $I_D = -100\text{mA}$, $V_{EN} = 1.5\text{V}$		135	235	m Ω
		$V_{IN} = +3.6\text{V}$, $I_D = -100\text{mA}$, $V_{EN} = 1.5\text{V}$		140	255	m Ω
		$V_{IN} = +2.5\text{V}$, $I_D = -100\text{mA}$, $V_{EN} = 1.5\text{V}$		170	315	m Ω
		$V_{IN} = +1.8\text{V}$, $I_D = -100\text{mA}$, $V_{EN} = 1.5\text{V}$		235	355	m Ω
		$V_{IN} = +1.7\text{V}$, $I_D = -100\text{mA}$, $V_{EN} = 1.5\text{V}$		260	375	m Ω
$R_{SHUTDOWN}$	Turn-Off Resistance	$V_{IN} = +3.6\text{V}$, $I_{TEST} = 1\text{mA}$, $V_{EN} = 0\text{V}$ MIC94091/3/5		250	400	Ω

Electrical Characteristics (Dynamic)

$T_A = 25^\circ\text{C}$, bold values indicate $-40^\circ\text{C} \leq T_A \leq +85^\circ\text{C}$, unless noted.

Symbol	Parameter	Condition	Min	Typ	Max	Units
$t_{\text{ON_DLY}}$	Turn-On Delay Time	$V_{\text{IN}} = +3.6\text{V}$, $I_{\text{D}} = -100\text{mA}$, $V_{\text{EN}} = 1.5\text{V}$ MIC94090/1		0.4	1.5	μs
		$V_{\text{IN}} = +3.6\text{V}$, $I_{\text{D}} = -100\text{mA}$, $V_{\text{EN}} = 1.5\text{V}$ MIC94092/3	200	740	1500	μs
		$V_{\text{IN}} = +3.6\text{V}$, $I_{\text{D}} = -100\text{mA}$, $V_{\text{EN}} = 1.5\text{V}$ MIC94094/5	65	110	165	μs
$t_{\text{ON_RISE}}$	Turn-On Rise Time	$V_{\text{IN}} = +3.6\text{V}$, $I_{\text{D}} = -100\text{mA}$, $V_{\text{EN}} = 1.5\text{V}$ MIC94090/1		0.4	1.5	μs
		$V_{\text{IN}} = +3.6\text{V}$, $I_{\text{D}} = -100\text{mA}$, $V_{\text{EN}} = 1.5\text{V}$ MIC94092/3	400	790	1500	μs
		$V_{\text{IN}} = +3.6\text{V}$, $I_{\text{D}} = -100\text{mA}$, $V_{\text{EN}} = 1.5\text{V}$ MIC94094/5	65	120	175	μs
$t_{\text{OFF_DLY}}$	Turn-Off Delay Time	$V_{\text{IN}} = +3.6\text{V}$, $I_{\text{D}} = -100\text{mA}$, $V_{\text{EN}} = 1.5\text{V}$		60	200	ns
$t_{\text{OFF_FALL}}$	Turn-Off Fall Time	$V_{\text{IN}} = +3.6\text{V}$, $I_{\text{D}} = -100\text{mA}$, $V_{\text{EN}} = 1.5\text{V}$		10	100	ns

Notes:

1. Exceeding the absolute maximum rating may damage the device.
2. The device is not guaranteed to function outside its operating rating.
3. With backside thermal contact to PCB. See thermal considerations section.
4. Pulse width $< 300\mu\text{s}$ with $< 2\%$ duty cycle.
5. Continuous body diode current conduction (reverse conduction, i.e. V_{OUT} to V_{IN}) is not recommended.
6. Devices are ESD sensitive. Handling precautions recommended. HBM (Human body model), $1.5\text{k}\Omega$ in series with 100pF .
7. Measured on the MIC94090YMT.

Typical Characteristics

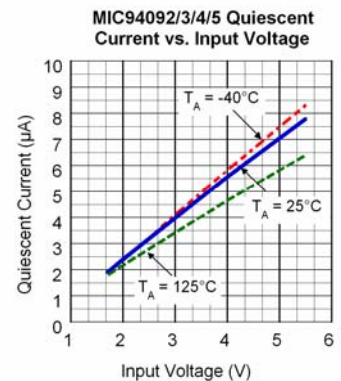
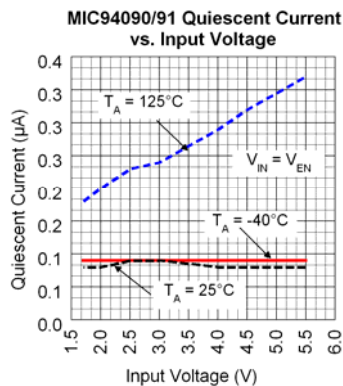
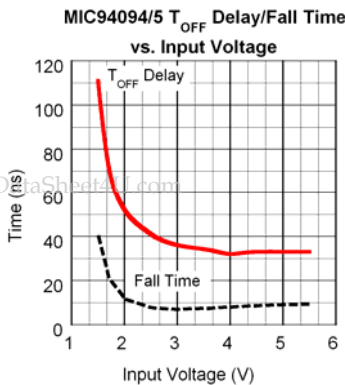
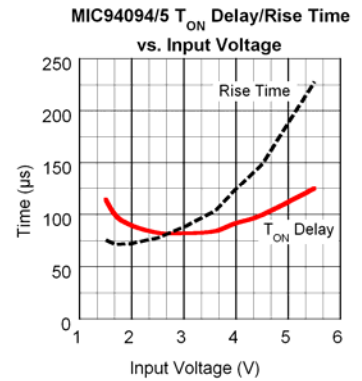
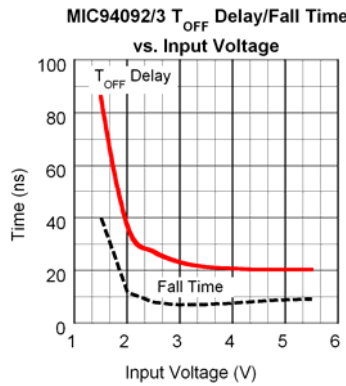
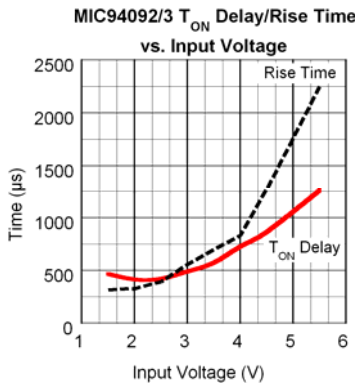
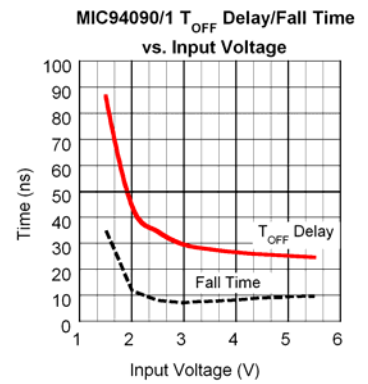
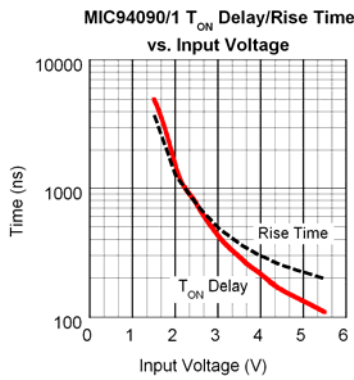
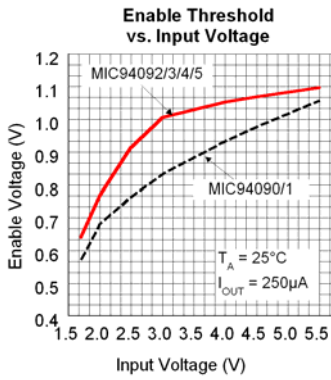
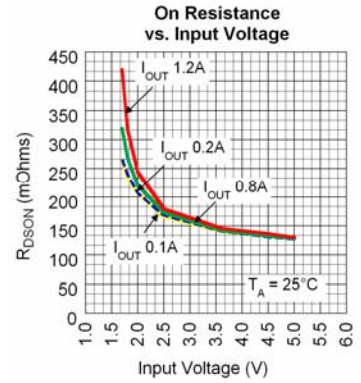
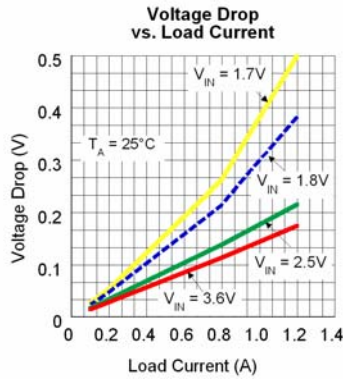
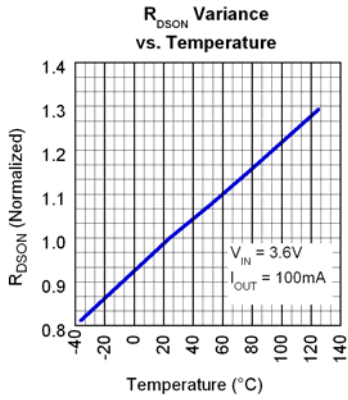

Typical Characteristics

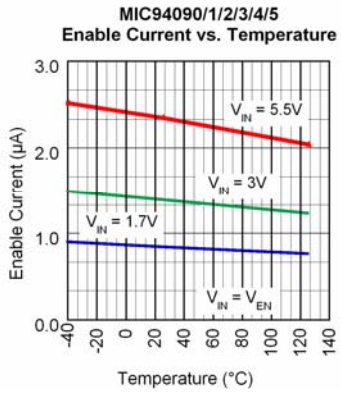

Functional Characteristics

MIC94090

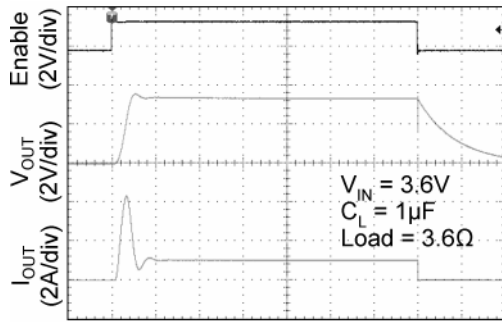

TIME (4µs/div)

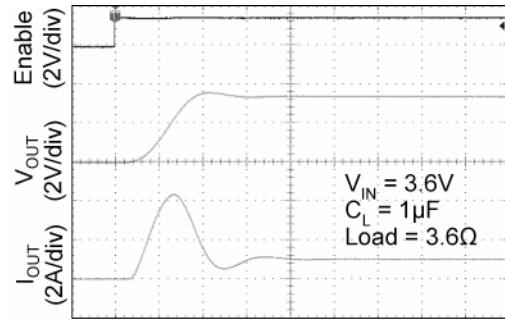

TIME (1µs/div)

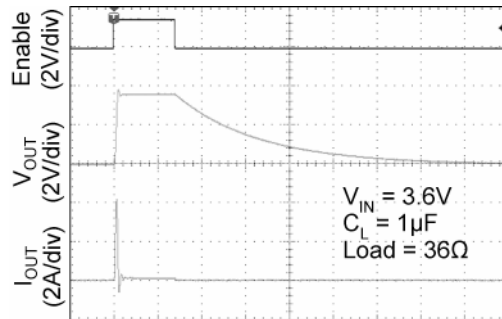

TIME (20µs/div)

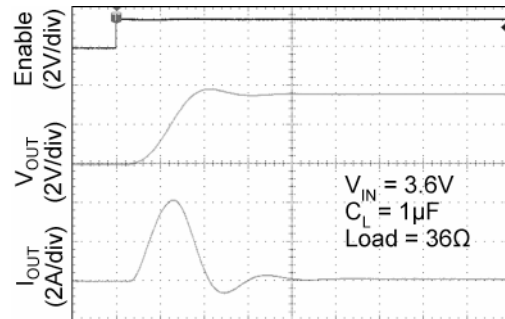

TIME (1µs/div)

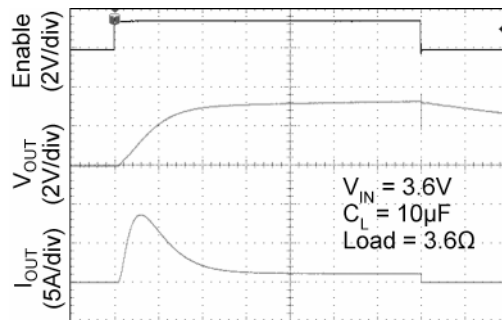

TIME (4µs/div)

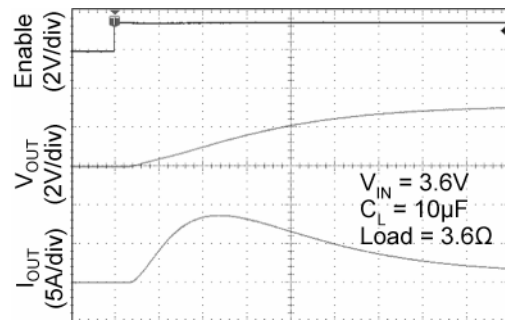

TIME (1µs/div)

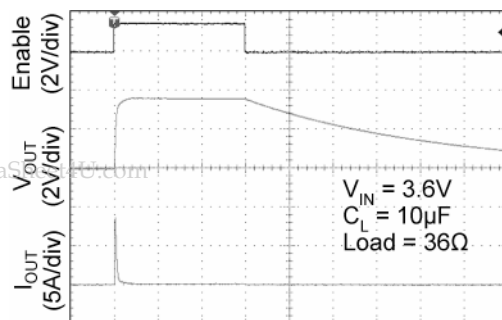

TIME (100µs/div)

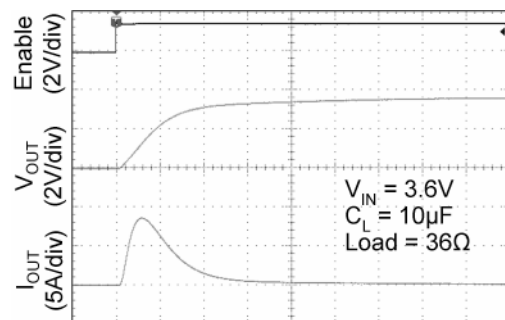

TIME (4µs/div)

www.DataSheet4U.com

MIC94091

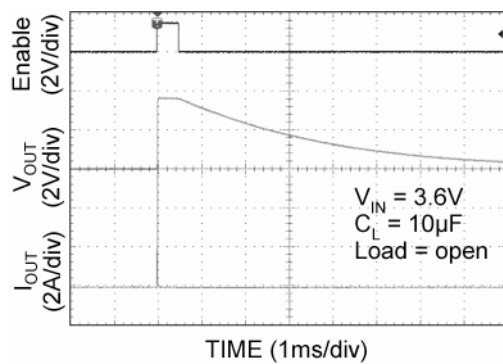
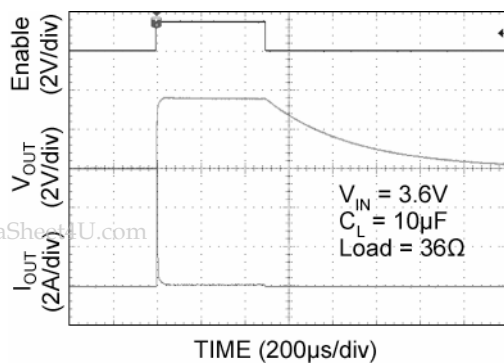
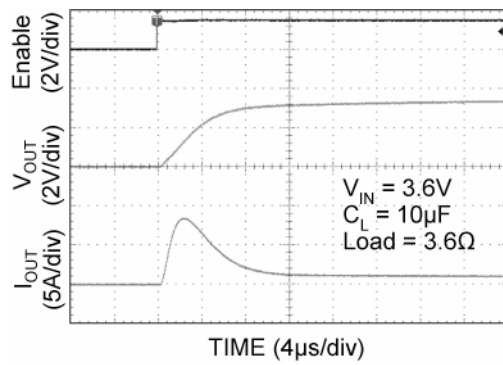
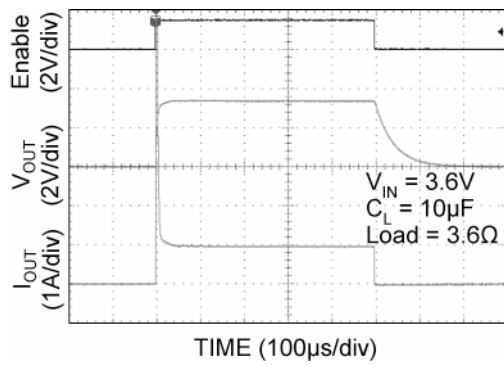
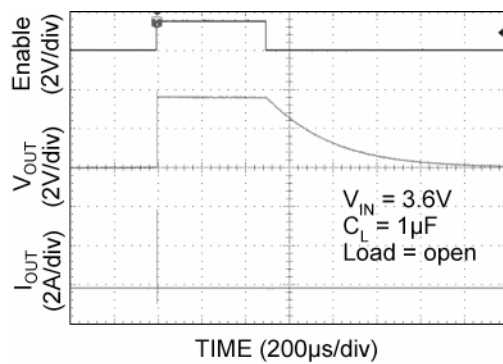
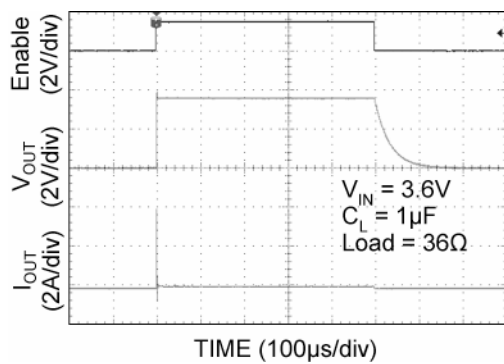
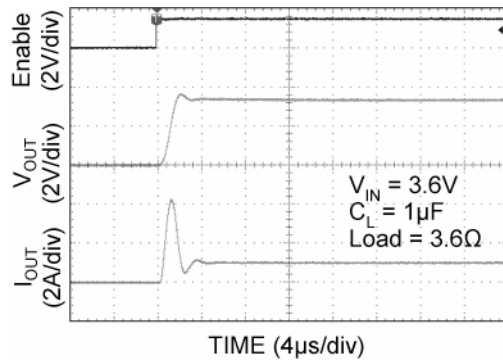
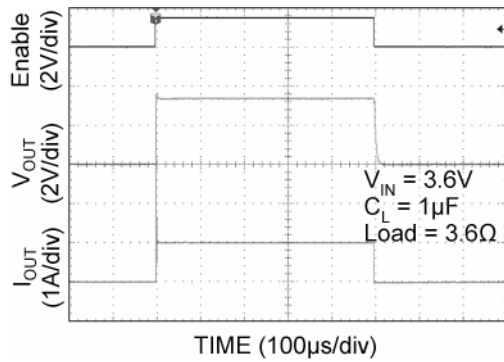

www.DataSheet4U.com

MIC94092

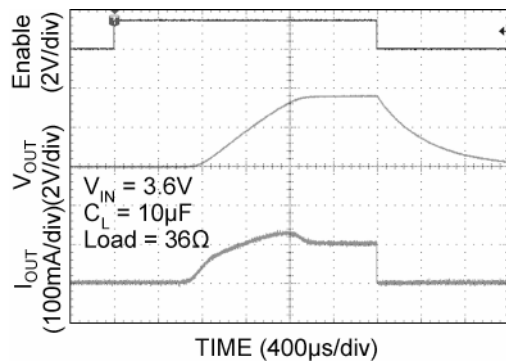
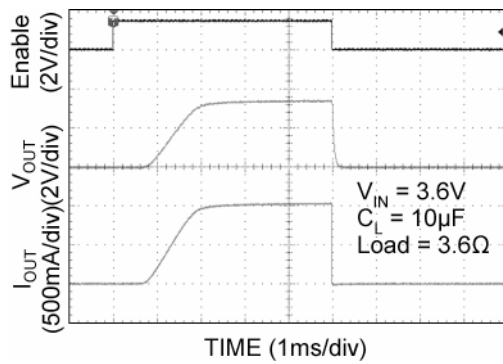
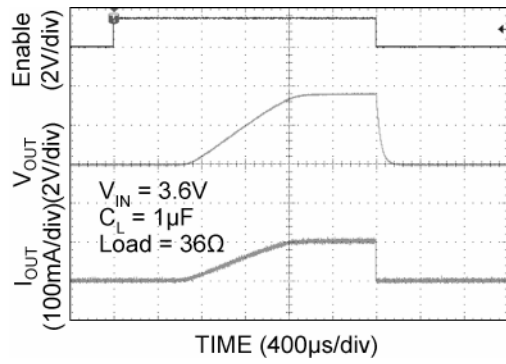
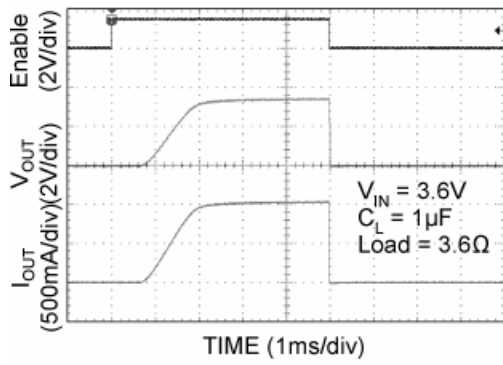

MIC94093

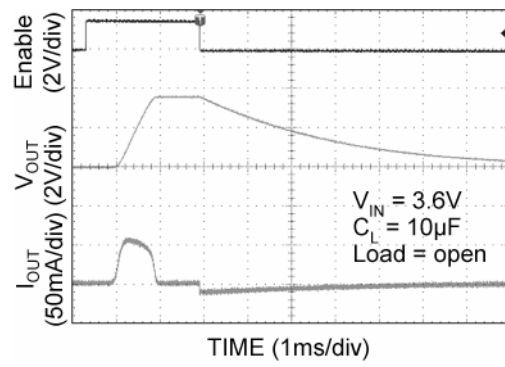
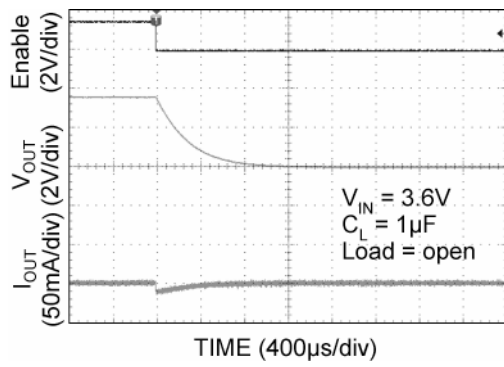
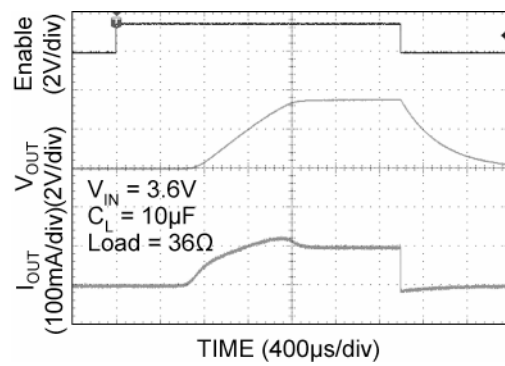
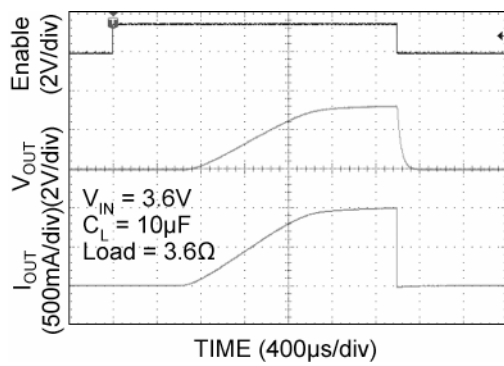
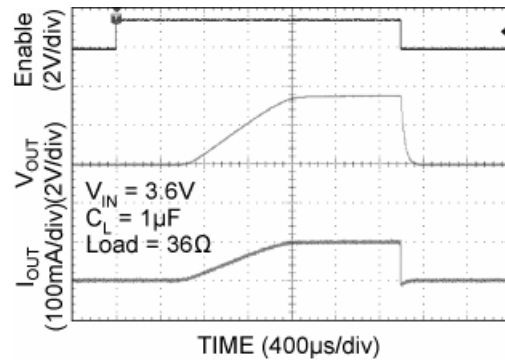
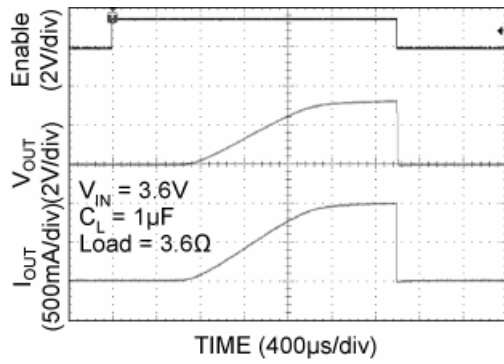

MIC94094

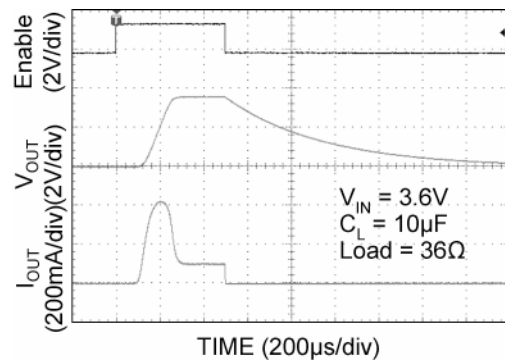
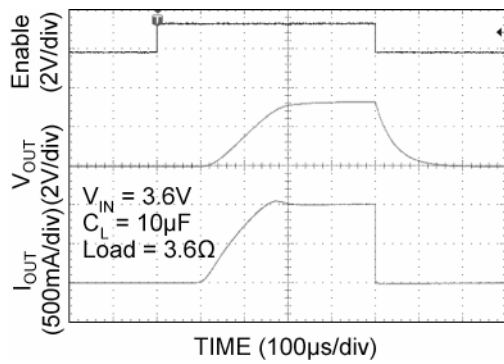
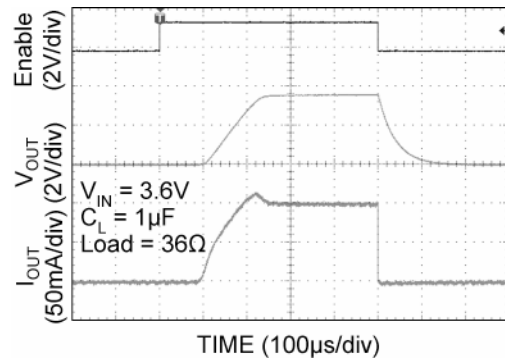
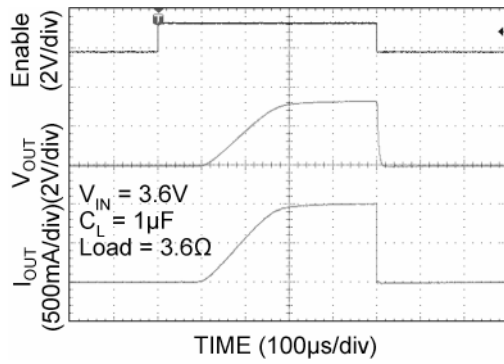

MIC94095

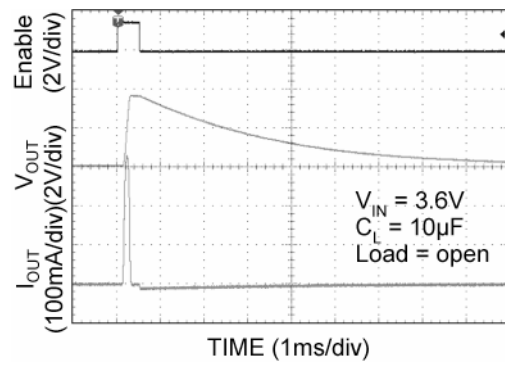
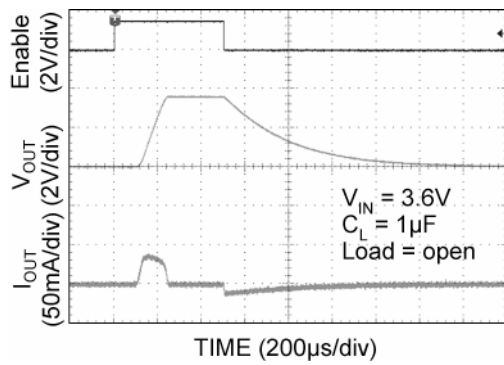
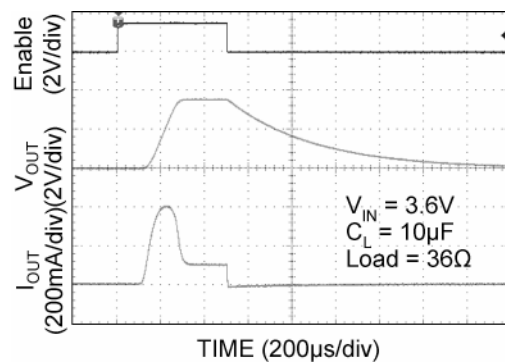
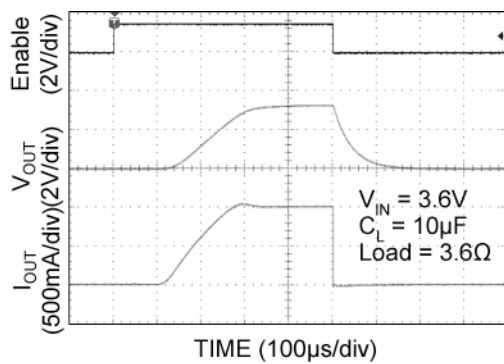
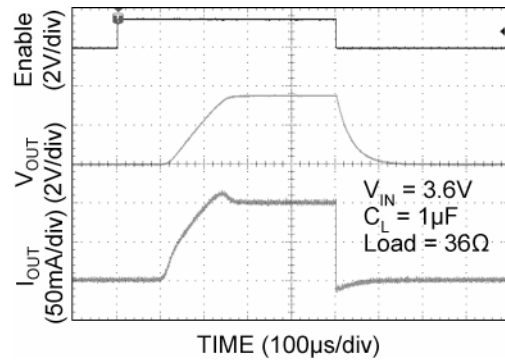
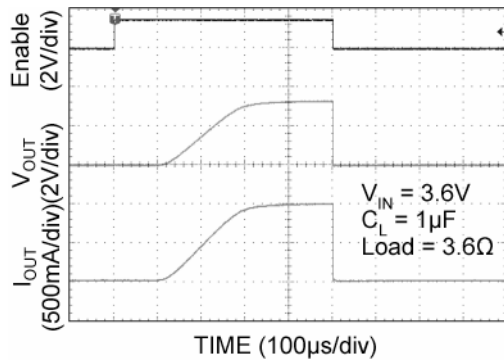

Application Information

Power Dissipation Considerations

As with all power switches, the ultimate current rating of the switch is limited by the thermal properties of the package and the PCB it is mounted on. There is a simple, ohms law type relationship between thermal resistance, power dissipation and temperature which are analogous to an electrical circuit:

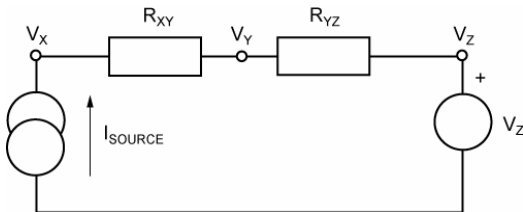

Figure 1. Electrical Circuit

From this simple circuit we can calculate V_X if we know I_{SOURCE} , V_Z and the resistor values, R_{XY} and R_{YZ} using the equation:

$$V_X = I_{SOURCE} \cdot (R_{XY} + R_{YZ}) + V_Z$$

Thermal circuits can be considered using these same rules and can be drawn similarly replacing current sources with Power dissipation (in Watts), Resistance with Thermal Resistance (in $^{\circ}C/W$) and Voltage sources with temperature (in $^{\circ}C$).

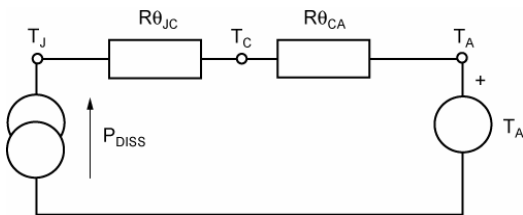

Figure 2. Thermal Equivalent Circuit

Now replacing the variables in the equation for V_X , we can find the junction temperature (T_J) from power dissipation, ambient temperature and the known thermal resistance of the PCB ($R_{\theta_{CA}}$) and the package ($R_{\theta_{JA}}$).

$$T_J = P_{DISS} \cdot (R_{\theta_{JC}} + R_{\theta_{CA}}) + T_{AMB} \quad (1)$$

It is this equation that is used to determine the graphs on page 7. P_{DISS} is calculated as $(I_{SWITCH}^2 \times R_{SWmax})$. $R_{\theta_{JC}}$ is found in the operating ratings section of the datasheet and $R_{\theta_{CA}}$ (the PCB thermal resistance) values for various PCB copper areas can be taken from 'Designing with Low Dropout Voltage Regulators'⁽¹⁾ available from the Micrel website (LDO Application Hints).

Example:

A switch is intended to drive a 500mA load and is placed on a printed circuit board which has a ground plane area of at least 25mm square. The Voltage source is a Li-ion battery with a lower operating threshold of 3V and the ambient temperature of the assembly can be up to 50 $^{\circ}C$.

Summary of variables:

$$I_{SW} = 0.5A$$

$$V_{IN} = 3V \text{ to } 4.2V$$

$$T_{amb} = 50^{\circ}C$$

$$R_{\theta_{JC}} = 60^{\circ}C/W \text{ from Datasheet (P. 3)}$$

$$R_{\theta_{CA}} = 53^{\circ}C/W \text{ Read from Graph in Fig. 3}$$

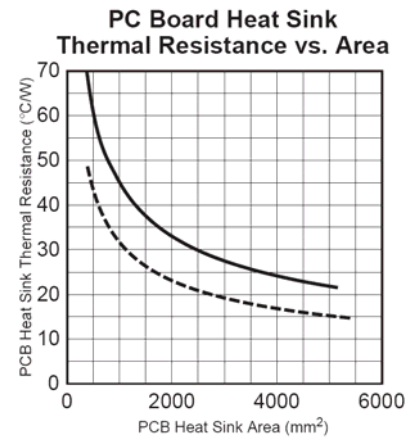

Figure 3. Excerpt from the LDO Book⁽¹⁾

$$P_{DISS} = I_{SW}^2 \times R_{SWmax}$$

The worst case switch resistance (R_{SWmax}) at the lowest V_{IN} of 3V is not available in the datasheet, so the next lower value of V_{IN} is used.

$$R_{SWmax} @ 2.5v = 315m\Omega$$

If this were a figure for worst case R_{SWmax} for 25 $^{\circ}C$, an additional consideration is to allow for the maximum junction temperature of 125 $^{\circ}C$, the actual worst case resistance in this case will be 30% higher (See $R_{DS(on)}$ variance vs. temperature graph).

$$R_{SWmax} @ 2.5v (@ 125^{\circ}C) = 315 \times 1.3 = 410m\Omega$$

Therefore junction temperature (T_J):

$$T_J = 0.5^2 \times 0.41 \times (60+53) + 50 \quad \text{from (Eqn. 1)}$$

$$T_J = 62^{\circ}C$$

This is well below the maximum 125 $^{\circ}C$.

Package Information

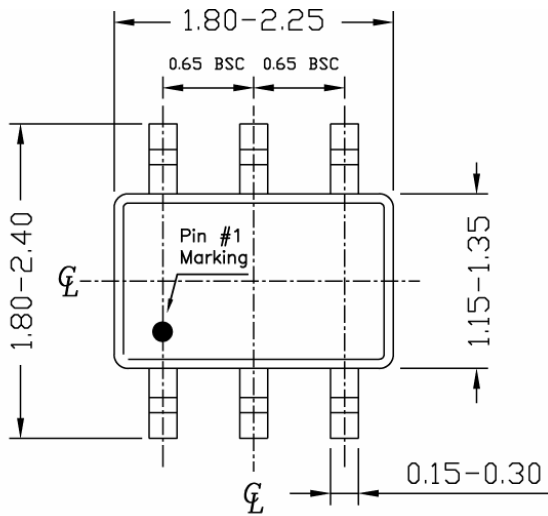

TOP VIEW

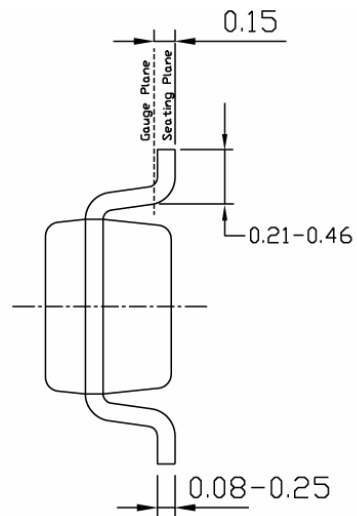

END VIEW

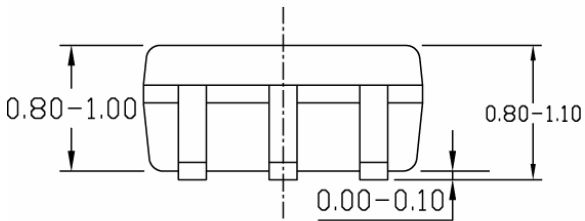

SIDE VIEW

NOTE:

1. ALL DIMENSIONS ARE IN MILLIMETERS.
2. DIMENSIONS ARE INCLUSIVE OF PLATING.
3. DIMENSIONS ARE EXCLUSIVE OF MOLD FLASH & METAL BURR.

6-Pin SC-70 (C6)

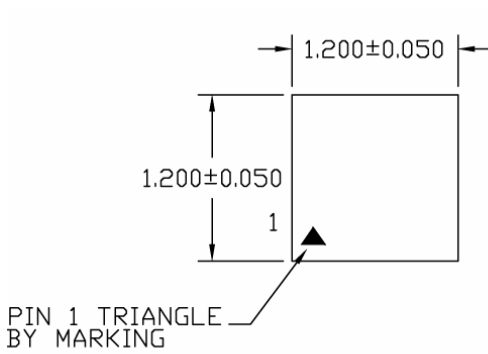

TOP VIEW

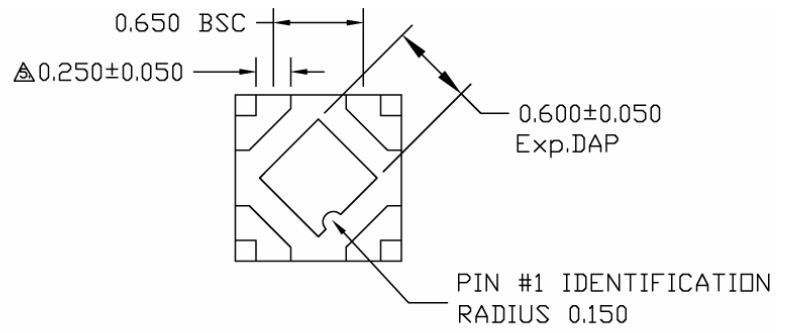

BOTTOM VIEW

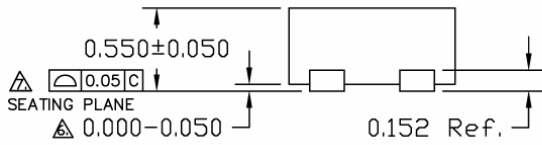

SIDE VIEW

- NOTES :
1. ALL DIMENSIONS ARE IN MILLIMETERS.
 2. MAX. PACKAGE WARPAGE IS 0.05 mm.
 3. MAXIMUM ALLOWABLE BURRS IS 0.076 mm IN ALL DIRECTIONS.
 4. PIN #1 ID ON TOP WILL BE LASER/INK MARKED.
- ⚠ DIMENSION APPLIES TO METALIZED TERMINAL AND IS MEASURED BETWEEN 0.20 AND 0.25 mm FROM TERMINAL TIP.
- ⚠ APPLIED ONLY FOR TERMINALS.
- ⚠ APPLIED FOR EXPOSED PAD AND TERMINALS.

4-Pin Thin MLF® (MT)

Landing Pattern

All units are in mm
Tolerance ± 0.05 if not noted

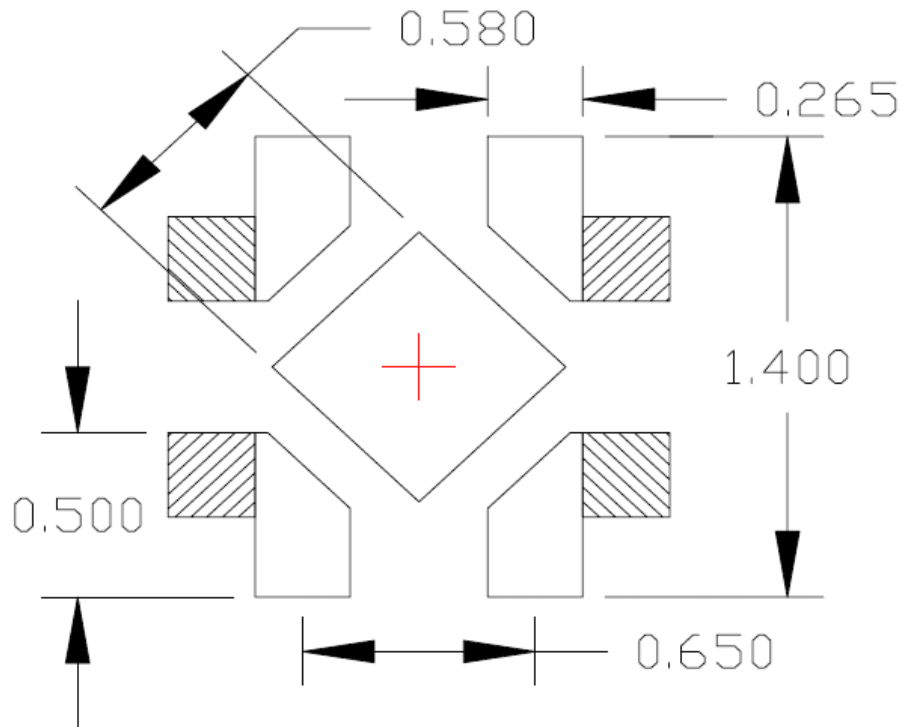

Disclaimer: This is only a recommendation based on information available to Micrel from its suppliers. Actual land pattern may have to be significantly different due to various materials and processes used in PCB assembly. Micrel makes no representation or warranty of performance based on the recommended land pattern."

Optional for maximum thermal performance. Heatsink should be connected to GND plane of PCB for maximum thermal performance.

Suggested Land Pattern 4-Pin Thin MLF[®] (MT)

MICREL, INC. 2180 FORTUNE DRIVE SAN JOSE, CA 95131 USA
TEL +1 (408) 944-0800 FAX +1 (408) 474-1000 WEB <http://www.micrel.com>

The information furnished by Micrel in this data sheet is believed to be accurate and reliable. However, no responsibility is assumed by Micrel for its use. Micrel reserves the right to change circuitry and specifications at any time without notification to the customer.

Micrel Products are not designed or authorized for use as components in life support appliances, devices or systems where malfunction of a product can reasonably be expected to result in personal injury. Life support devices or systems are devices or systems that (a) are intended for surgical implant into the body or (b) support or sustain life, and whose failure to perform can be reasonably expected to result in a significant injury to the user. A Purchaser's use or sale of Micrel Products for use in life support appliances, devices or systems is a Purchaser's own risk and Purchaser agrees to fully indemnify Micrel for any damages resulting from such use or sale.

© 2009 Micrel, Incorporated.

Вы скачали этот файл с сайта «Сайт радиолюбителей»



Другие разделы сайта

Раздел БИБЛИОТЕКА

Книги для и журналы радиолюбителям

<http://radio-uchebnik.ru/library/>

Раздел РАДИОСХЕМЫ

Различные схемы как для начинающих так и для профессионалов:

Схемы бытовой техники, телевизоров, мониторов, автомагнитол, музыкальных центров, и для самостоятельной сборки

<http://radio-uchebnik.ru/shem/>

Раздел ФАЙЛОВОЕ ХРАНИЛИЩЕ

Различные файлы: Даташиты, схемы, прошивки и так далее

<http://radio-uchebnik.ru/downfiles/>

Раздел РАДИОКОМПАС

Если Вы занимаетесь ремонтом электроники на профессиональном уровне- то Вы можете сообщить о себе.

<http://radio-uchebnik.ru/radiomap/>

Раздел ДОСКА ОБЪЯВЛЕНИЙ

Здесь Вы можете разместить бесплатное объявление сроком до 120 дней (только радиотематика!!)

<http://radio-uchebnik.ru/ads/>

Раздел СПРАВОЧНИК ПО МИКРОСХЕМАМ

Справочные данные на микросхемы импортного и отечественного производства

<http://radio-uchebnik.ru/microbase/>

Раздел СТАТЬИ

Различные статьи радиолюбительской (и не только) тематики: секреты телемастера, практическая электроника, альтернативная энергия, расчеты по электронике, электронные устройства и так далее

<http://radio-uchebnik.ru/txt/>

ФОРУМ НАШЕГО САЙТА

<http://radio-uchebnik.ru/forum/>