

User Programmable Micro-Power Voltage Detectors

General Description

The RT9801 is a micro-power voltage detector supervising the power supply voltage level for microprocessors (μP) or digital systems. It provides user programmable threshold levels with 0.1V step ranging from 1.5V to 5V, which covers most digital applications. It features low supply current of $3\mu\text{A}$. Selection of V_{TH} is easily achieved through 3 pins connected to GND, VDD or floating for different threshold voltage settings. Two versions of threshold voltages, 1.5V ~ 4V and 2.5V ~ 5V, which are programmed in factory are offered by customer demands.

The RT9801 performs supervisory function by sending out a reset signal whenever the VDD voltage falls below a preset threshold level. This reset signal will last the whole period before VDD recovering. Reset signal will release after VDD is recovered and lasts for the whole period of Reset Active Time-out period.

RT9801 is N-channel, open-drain output and provided in SOT-26 package.

Ordering Information

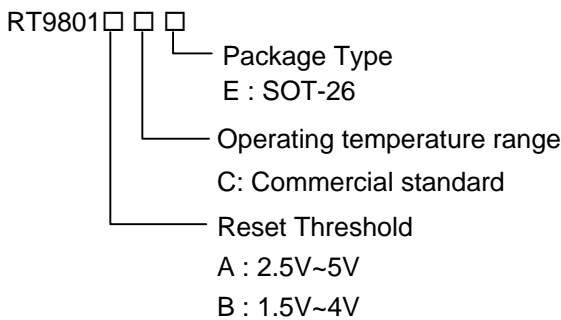

Marking Information

Part Number	Marking
RT9801ACE	1J
RT9801BCE	1K

Features

- User Programmable Threshold 1.5V to 5V in 0.1V Step with $\pm 3\%$ Accuracy
- Low Supply Current $3\mu\text{A}$
- Quick Reset within $20\mu\text{s}$
- Built-in Recovery Delay 200mS
- Low Functional Supply Voltage 0.9V
- Small SOT-26 Package

Applications

- Computers
- Controllers
- Intelligent Instruments
- Critical μP and μC Power Monitoring
- Portable/Battery-Powered Equipment

Pin Configurations

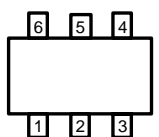
Part Number	Pin Configurations
RT9801□CE (Plastic SOT-26)	<div style="display: flex; align-items: center;">  <div style="margin-left: 20px;"> <p>TOP VIEW</p> <ol style="list-style-type: none"> 1. VSET0 2. GND 3. RESET 4. VDD 5. VSET2 6. VSET1 </div> </div>

Typical Application Circuit

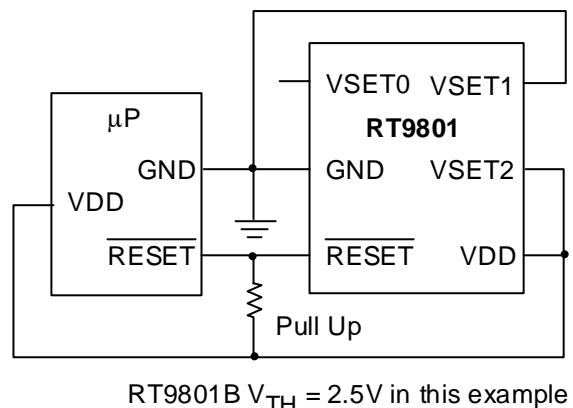

Pin Description

Pin Name	Pin Function
VSET0	Threshold Voltage Selection Pin 1
GND	Ground Pin
$\overline{\text{RESET}}$	Reset Pulse Output, Negative Pulse
VDD	Power Pin
VSET1	Threshold Voltage Selection Pin 2
VSET2	Threshold Voltage Selection Pin 3

Function Block Diagram

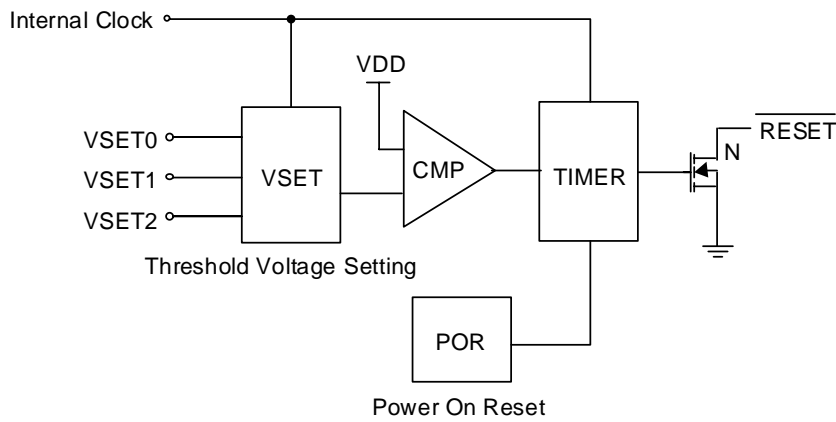

Absolute Maximum Ratings

- Terminal Voltage (with Respect to GND)
 - VDD ----- -0.3V to 6.0V
 - All Other Inputs ----- -0.3V to VDD+0.3V
- Input Current, VDD ----- 20mA
- Continuous Power Dissipation, P_D @ T_A = 25°C
 - SOT-26 ----- 0.25W
- Operating Junction Temperature Range ----- -40°C ~ 125°C
- Storage Temperature Range ----- -65°C ~ 125°C
- Package Thermal Resistance
 - SOT-26, θ_{JA} ----- 250°C /W
- Lead Temperature (Soldering, 5sec.) ----- 260°C

Electrical Characteristics

(VDD = 3V, unless specified)

Parameter	Symbol	Test Conditions	Min	Typ	Max	Units
Operating VDD (V _{OUT}) Range	V _{DD}		0.9	--	6	V
Supply Current	I _{DD}	V _{DD} = 1.5V ~ 3.5V, I _{OUT} = 0	--	--	3	μA
		V _{DD} = 3.5V ~ 5V, I _{OUT} = 0	--	--	3.3	
Reset Threshold	V _{TH}	T _A = 27°C	--	Note1	--	V
Threshold Voltage Accuracy	ΔV _{TH}	T _A = 27°C	--	--	3	%
V _{CC} Drop to Reset Delay	t _{RD}	Drop = -125mV	--	--	20	μS
Reset Active Time Out Period	t _{RP}	V _{DD} ≥ 1.02×V _{TH} , Programmable	--	200	--	mS
VSET Pin Input Threshold	V _{IL}	T _A = 27°C	--	0.15V _{DD}	--	V
	V _{IH}	T _A = 27°C	--	0.85V _{DD}	--	
$\overline{\text{RESET}}$ Output Voltage	V _{OL}	V _{DD} < V _{TH} , I _{SINK} = 3.5mA	--	0.4	--	V

Note 1: Pin Conditions for Programmable Threshold Voltage Setting

RT9801A	RT9801B	Vset0 input	Vset1 input	Vset2 input
5	4	V _{DD}	V _{DD}	V _{DD}
4.9	3.9	V _{DD}	V _{DD}	floating
4.8	3.8	V _{DD}	V _{DD}	GND
4.7	3.7	V _{DD}	floating	V _{DD}
4.6	3.6	V _{DD}	floating	floating
4.5	3.5	V _{DD}	floating	GND
4.4	3.4	V _{DD}	GND	V _{DD}
4.3	3.3	V _{DD}	GND	floating
4.2	3.2	V _{DD}	GND	GND
4.1	3.1	floating	V _{DD}	V _{DD}
4	3	floating	V _{DD}	floating
3.9	2.9	floating	V _{DD}	GND
3.8	2.8	floating	floating	V _{DD}
3.7	2.7	floating	floating	floating
3.6	2.6	floating	floating	GND
3.5	2.5	floating	GND	V _{DD}
3.4	2.4	floating	GND	floating
3.3	2.3	floating	GND	GND
3.2	2.2	GND	V _{DD}	V _{DD}
3.1	2.1	GND	V _{DD}	floating
3	2	GND	V _{DD}	GND
2.9	1.9	GND	floating	V _{DD}
2.8	1.8	GND	floating	floating
2.7	1.7	GND	floating	GND
2.6	1.6	GND	GND	V _{DD}
2.5	1.5	GND	GND	floating

V_{DD}: bond to V_{DD}; 0: bond to GND; f: no bonding

Typical Operating Characteristics

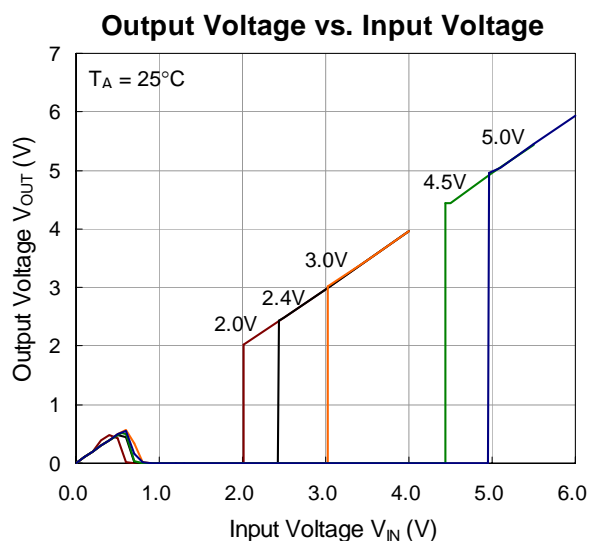
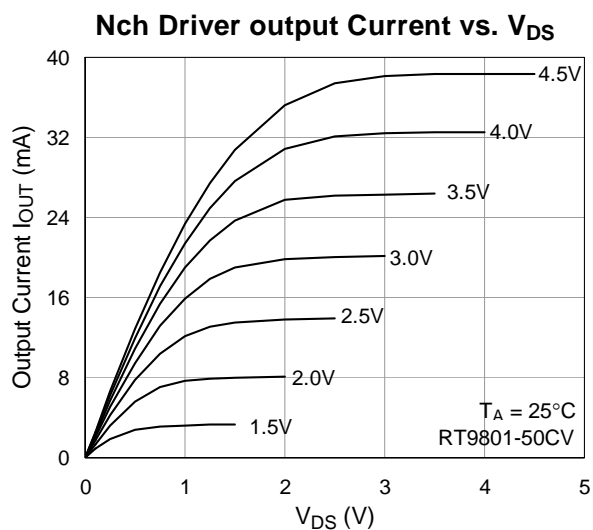
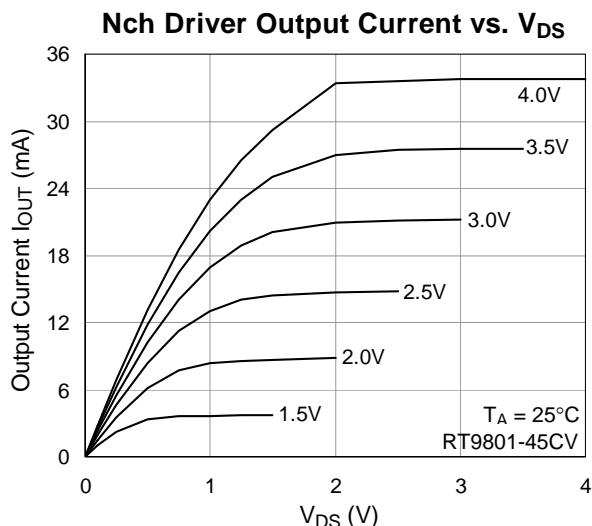
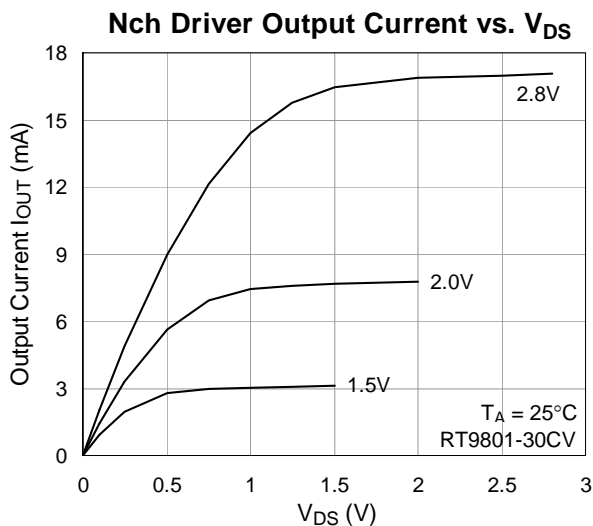
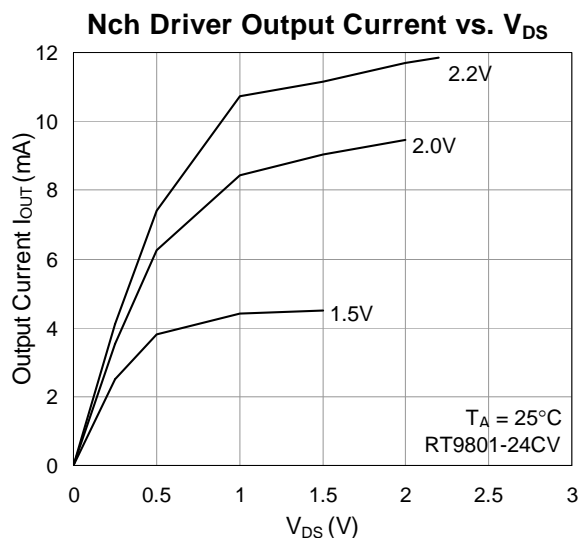
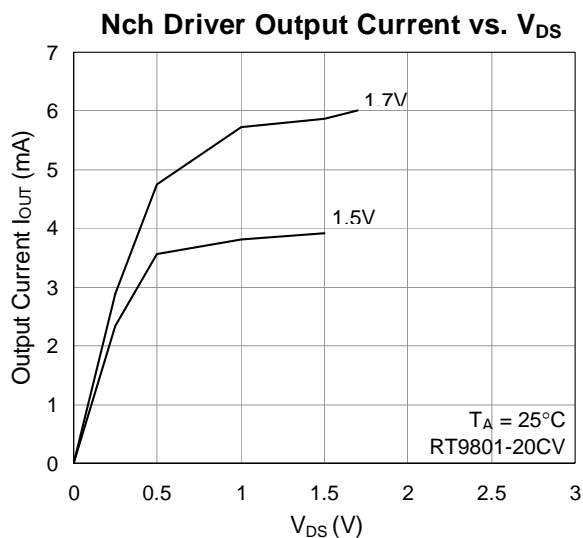

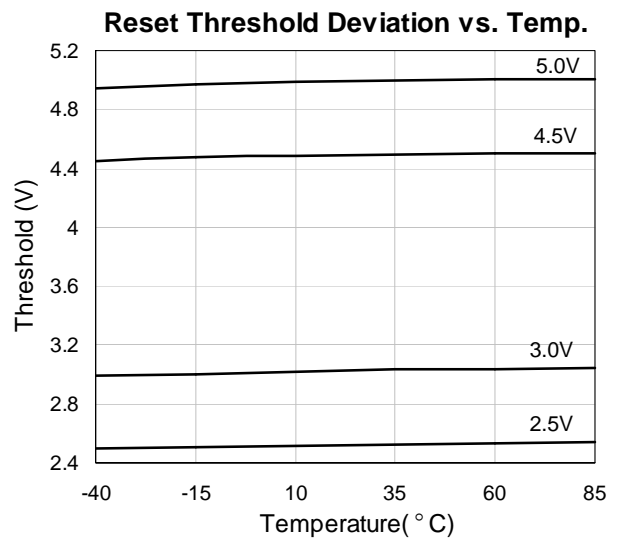
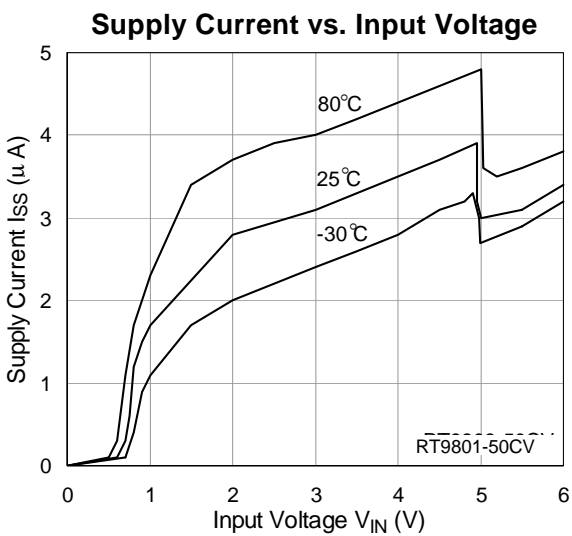
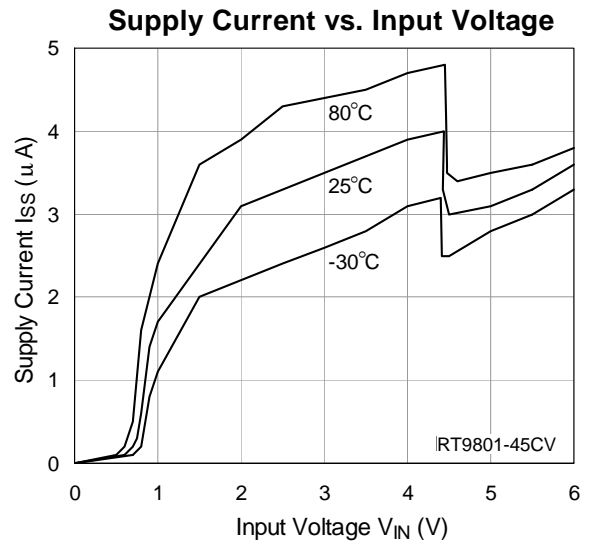
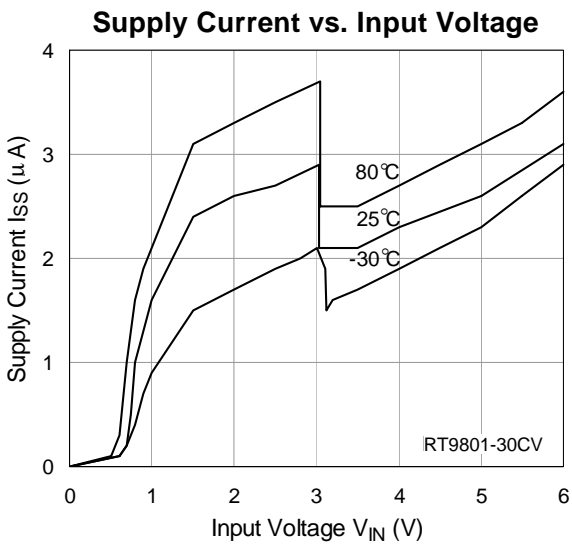
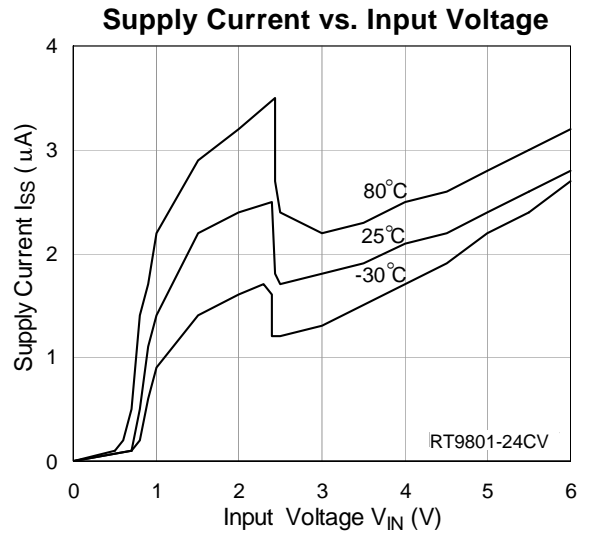
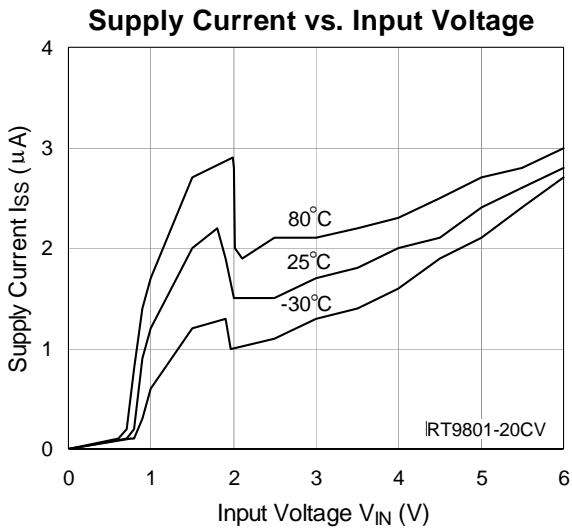

Nch Driver Output Current vs. Input Voltage

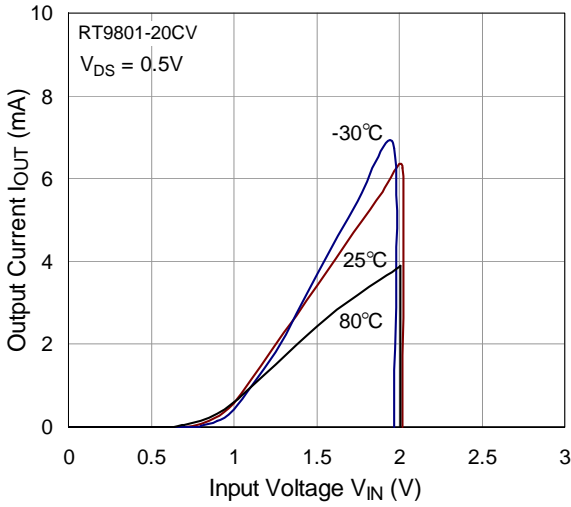

Nch Driver Output Current vs. Input Voltage

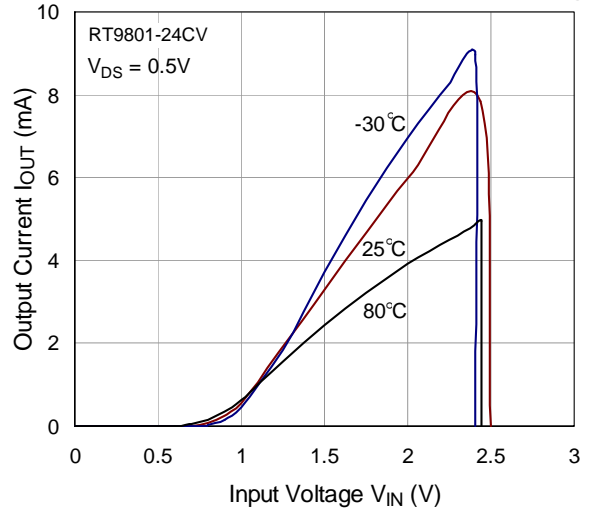

Nch Driver Output Current vs. Input Voltage

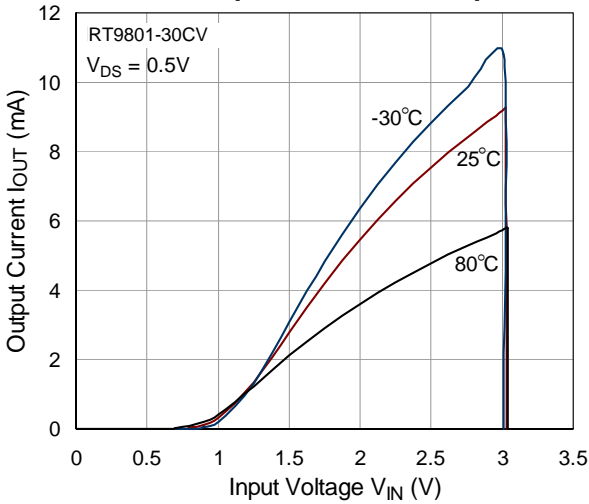

Nch Driver Output Current vs. Input Voltage

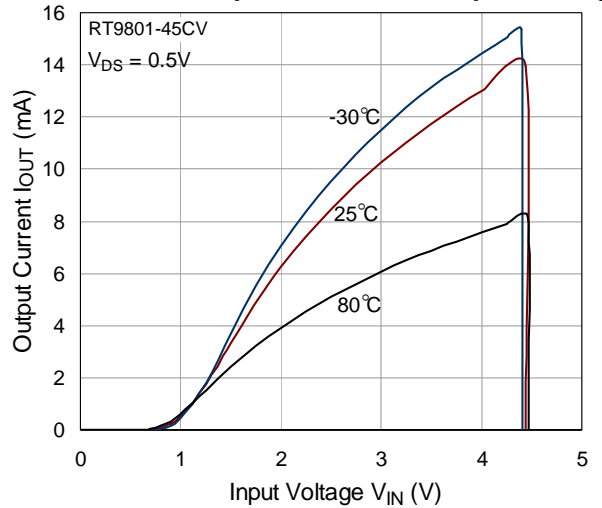

Nch Driver Output Current vs. Input Voltage

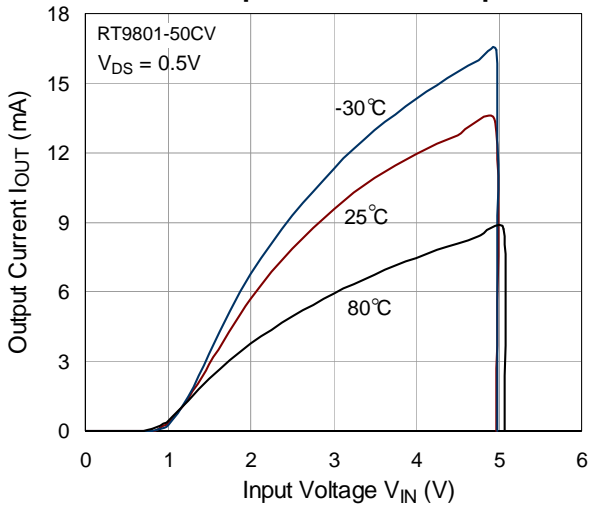

Power-Up reset Timeout vs. Temp.

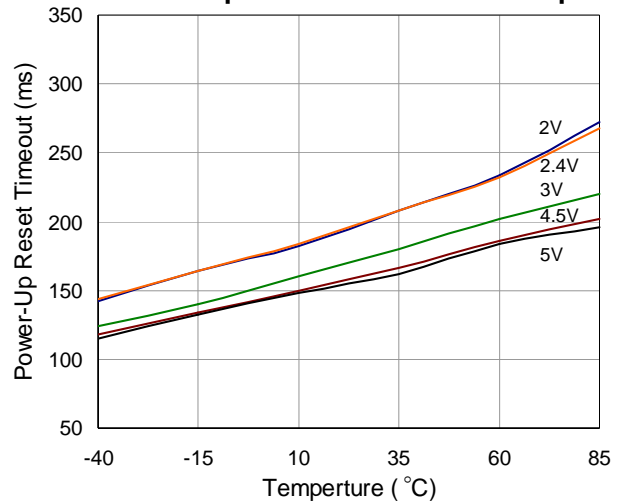

Power-Down Reset Delay vs. Temp.

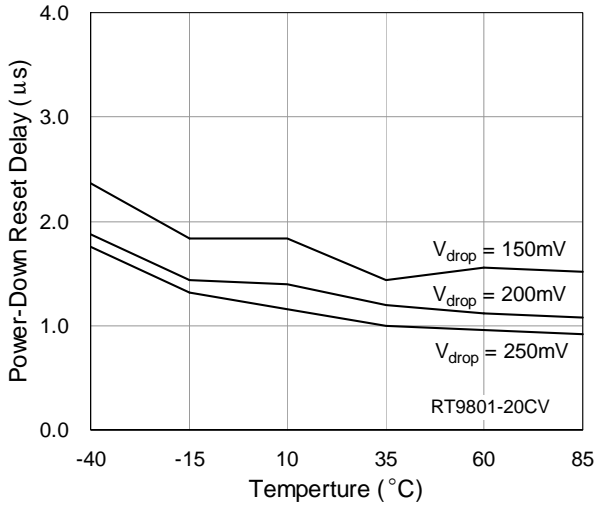

Power-Down Reset Delay vs. Temp.

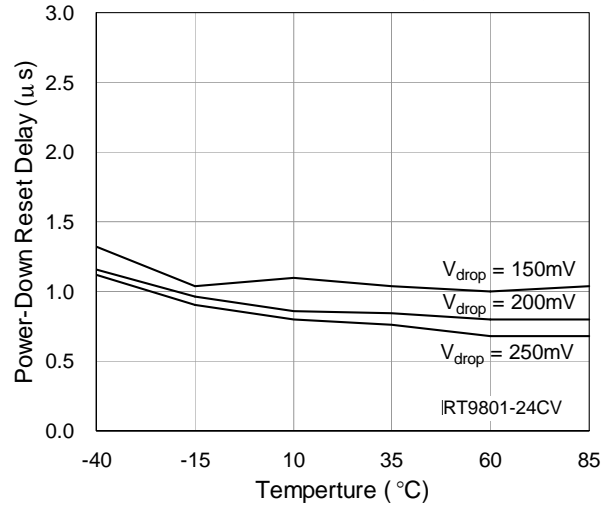

Power-Down Reset Delay vs. Temp.

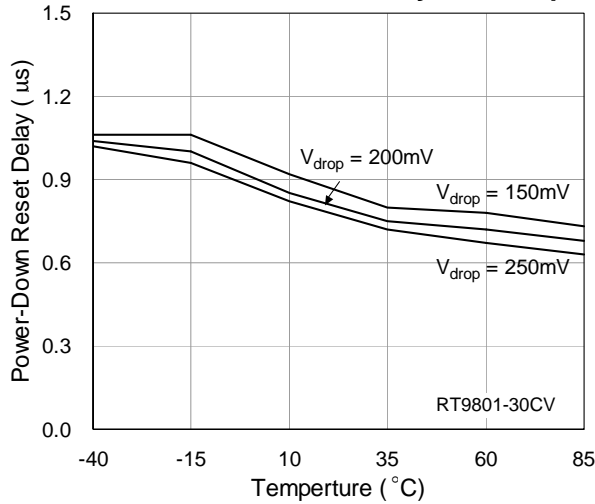

Power-Down Reset Delay vs. Temp.

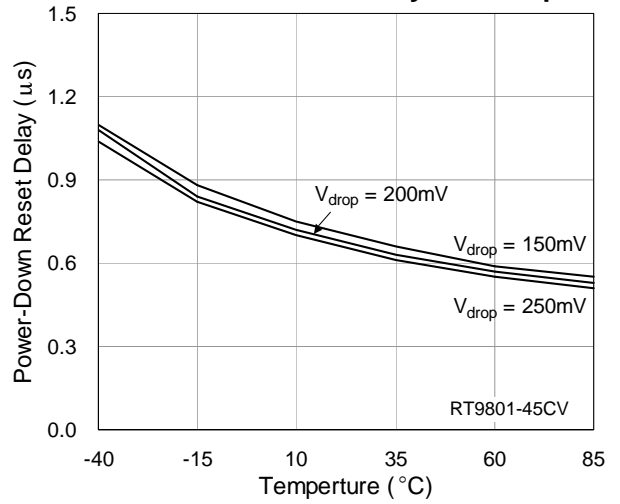

Power-Down Reset Delay vs. Temp.

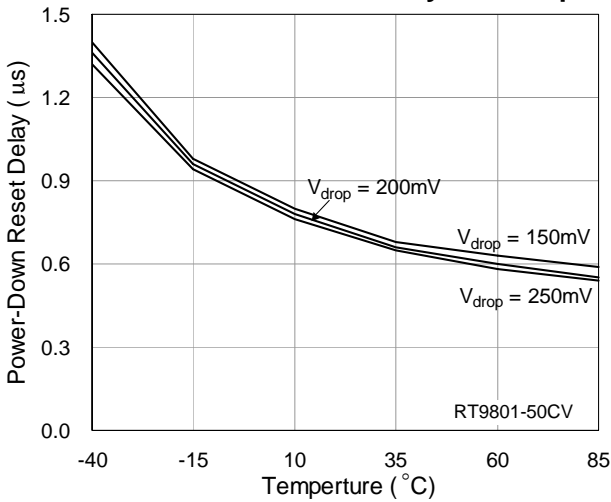

Output Delay Time vs. Load Capacitance

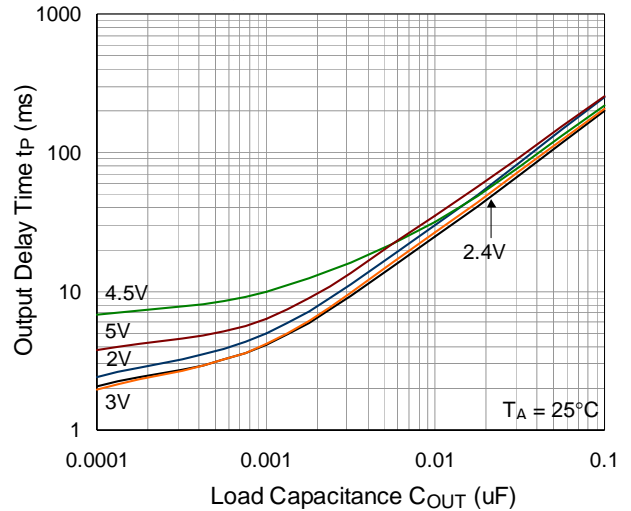

Package Information

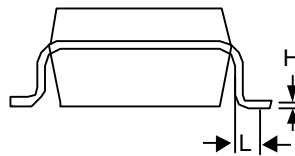
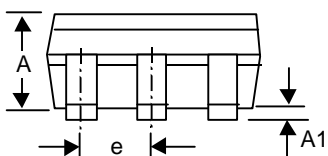
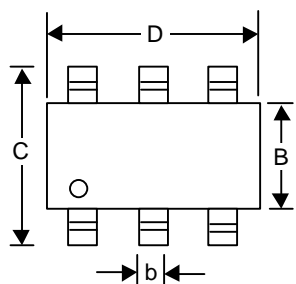

Symbol	Dimensions In Millimeters		Dimensions In Inches	
	Min	Max	Min	Max
A	0.889	1.295	0.035	0.051
A1	--	0.152	--	0.006
B	1.397	1.803	0.055	0.071
b	0.356	0.559	0.014	0.022
C	2.591	2.997	0.102	0.118
D	2.692	3.099	0.106	0.122
e	0.838	1.041	0.033	0.041
H	0.102	0.254	0.004	0.010
L	0.356	0.610	0.014	0.024

SOT- 26 Surface Mount Package