

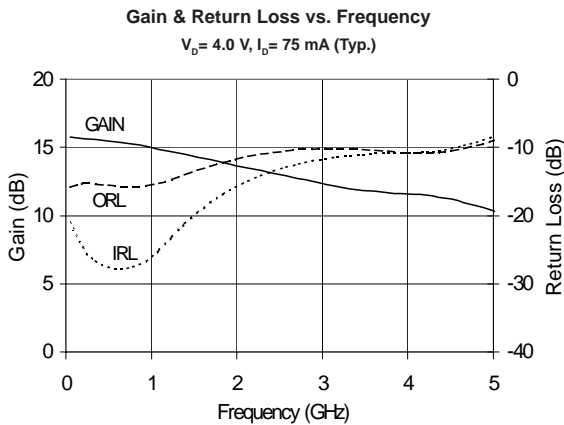

Product Description

The SGA-6389 is a high performance SiGe HBT MMIC Amplifier. A Darlington configuration featuring 1 micron emitters provides high F_T and excellent thermal performance. The heterojunction increases breakdown voltage and minimizes leakage current between junctions. Cancellation of emitter junction non-linearities results in higher suppression of intermodulation products. Only 2 DC-blocking capacitors, a bias resistor and an optional RF choke are required for operation.

The matte tin finish on Sirenza's lead-free package utilizes a post annealing process to mitigate tin whisker formation and is RoHS compliant per EU Directive 2002/95. This package is also manufactured with green molding compounds that contain



SGA-6389

SGA-6389Z RoHS Compliant & Green Package

DC-4500 MHz, Cascadable SiGe HBT MMIC Amplifier



Product Features

- Now available in Lead Free, RoHS Compliant, & Green Packaging
- Broadband Operation: DC-4500 MHz
- Cascadable 50ohm
- Patented SiGe Technology
- Operates From Single Supply
- Low Thermal Resistance Package

Applications

- PA Driver Amplifier
- Cellular, PCS, GSM, UMTS
- IF Amplifier
- Wireless Data, Satellite

| Symbol | Parameter | Units | Frequency | Min. | Typ. | Max. |
|---|---------------------------------------|----------------------|---------------------------------|------|----------------------|------|
| G | Small Signal Gain | dB | 850 MHz 1950 MHz 2400 MHz | 14.1 | 15.5 14.0 13.3 | 17.3 |
| P_{1dB} | Output Power at 1dB Compression | dBm | 850 MHz 1950 MHz | | 20.2 18.9 | |
| OIP_3 | Output Third Order Intercept Point | dBm | 850 MHz 1950 MHz | | 35.2 32.6 | |
| Bandwidth | Determined by Return Loss (>10dB) | MHz | | | 4500 | |
| IRL | Input Return Loss | dB | 1950 MHz | | 16.0 | |
| ORL | Output Return Loss | dB | 1950 MHz | | 11.9 | |
| NF | Noise Figure | dB | 1950 MHz | | 4.2 | |
| V_D | Device Operating Voltage | V | | 4.6 | 4.9 | 5.4 |
| I_D | Device Operating Current | mA | | 72 | 80 | 88 |
| R_{TH} , j-l | Thermal Resistance (junction to lead) | $^{\circ}\text{C/W}$ | | | 97 | |
| Test Conditions: $V_S = 8\text{v}$ $I_D = 80\text{mA Typ.}$ $OIP3$ Tone Spacing = 1 MHz, P_{out} per tone = 0 dBm $R_{BIAS} = 39\text{ ohms}$ $T_L = 25^{\circ}\text{C}$ $Z_S = Z_L = 50\text{ Ohms}$ | | | | | | |

The information provided herein is believed to be reliable at press time. Sirenza Microdevices assumes no responsibility for inaccuracies or omissions. Sirenza Microdevices assumes no responsibility for the use of this information, and all such information shall be entirely at the user's own risk. Prices and specifications are subject to change without notice. No patent rights or licenses to any of the circuits described herein are implied or granted to any third party. Sirenza

Typical RF Performance at Key Operating Frequencies

| Symbol | Parameter | Unit | Frequency (MHz) | | | | | |
|------------------|------------------------------------|------|-----------------|------|------|------|------|-------|
| | | | 100 | 500 | 850 | 1950 | 2400 | 3500 |
| G | Small Signal Gain | dB | 15.7 | 15.6 | 15.5 | 14.0 | 13.3 | 12.0. |
| OIP ₃ | Output Third Order Intercept Point | dBm | 36.6 | 36.0 | 35.2 | 32.6 | 31.2 | 26.8 |
| P _{1dB} | Output Power at 1dB Compression | dBm | 20.1 | 20.4 | 20.2 | 18.9 | 18.1 | 15.5 |
| IRL | Input Return Loss | dB | 22.3 | 27.5 | 27.4 | 16.0 | 13.7 | 11.0 |
| ORL | Output Return Loss | dB | 14.7 | 14.5 | 14.8 | 11.9 | 10.8 | 10.4 |
| S ₁₂ | Reverse Isolation | dB | 20.4 | 20.2 | 20.3 | 20.1 | 19.7 | 18.2 |
| NF | Noise Figure | dB | 4.0 | 3.7 | 3.8 | 4.2 | 4.4 | 4.8 |

Test Conditions: V_S = 8v, I_D = 80mA Typ., OIP3 Tone Spacing = 1 MHz, Pout per tone = 0 dBm
R_{BIAS} = 39 ohms, T_L = 25°C, Z_S = Z_L = 50 Ohms

Noise Figure vs. Frequency
V_D = 4.9 V, I_D = 80 mA

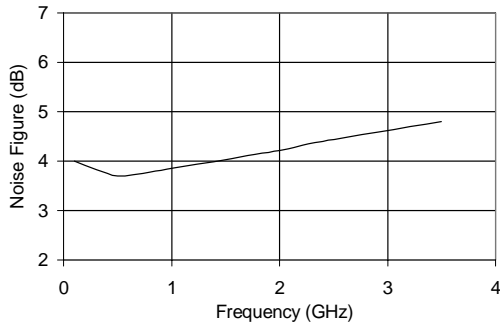

Absolute Maximum Ratings

| Parameter | Absolute Limit |
|---|----------------|
| Max. Device Current (I _D) | 160 mA |
| Max. Device Voltage (V _D) | 7 V |
| Max. RF Input Power | +18 dBm |
| Max. Junction Temp. (T _J) | +150°C |
| Operating Temp. Range (T _L) | -40°C to +85°C |
| Max. Storage Temp. | +150°C |

Operation of this device beyond any one of these limits may cause permanent damage. For reliable continuous operation, the device voltage and current must not exceed the maximum operating values specified in the table on page one.

Bias Conditions should also satisfy the following expression:
 $I_D V_D < (T_J - T_L) / R_{TH} \cdot I$

Take into account out of band VSWR presented by devices such as SAW filters to determine maximum RF input power. Reflected harmonic levels in saturation are significant.

OIP₃ vs. Frequency
V_D = 4.9 V, I_D = 80 mA

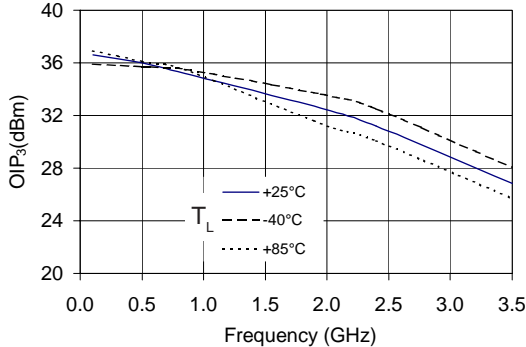

P_{1dB} vs. Frequency
V_D = 4.9 v, I_D = 80 mA

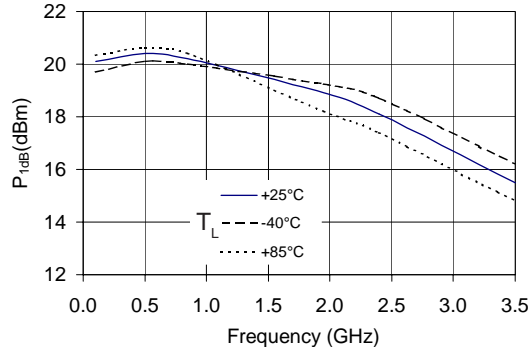

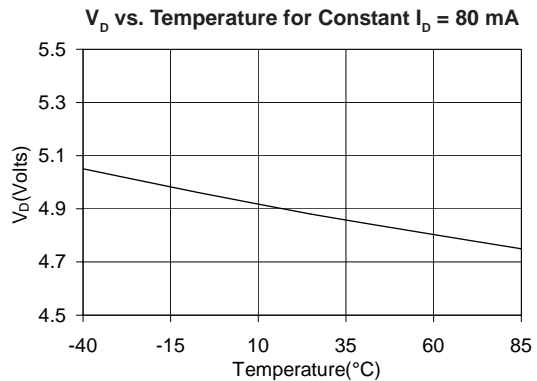
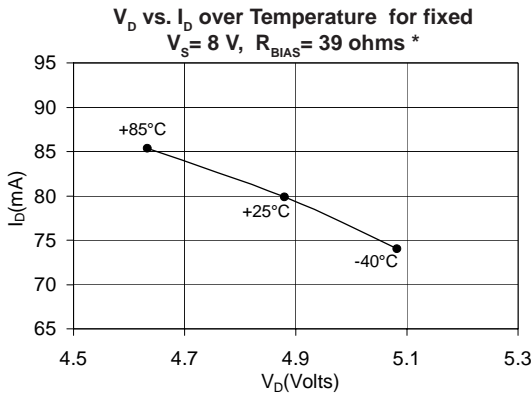
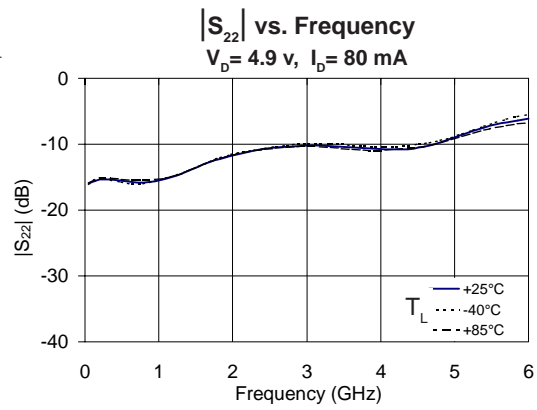
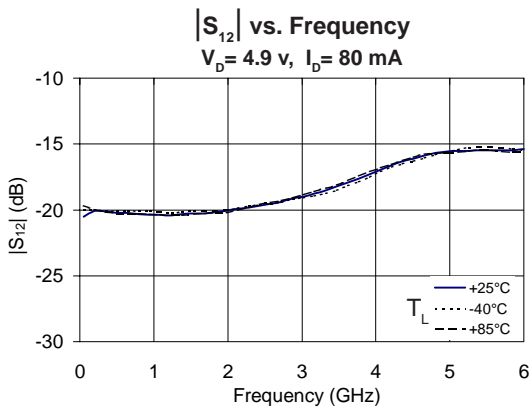
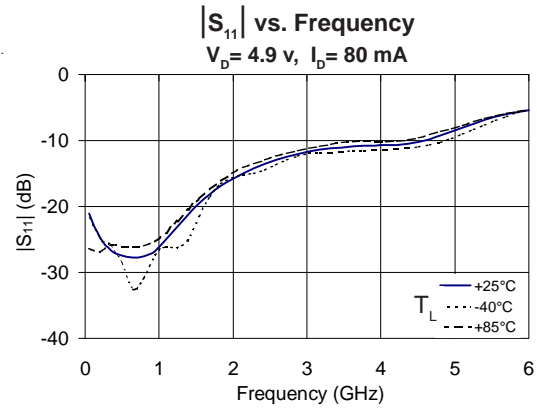
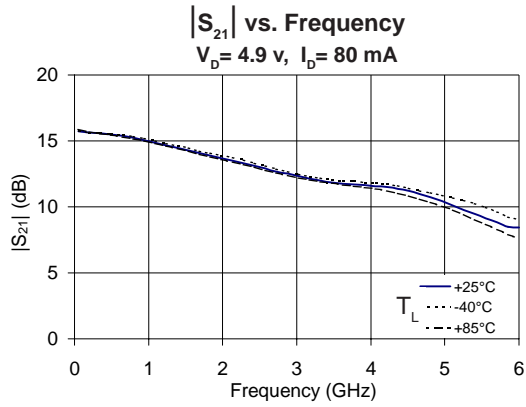

* Note: In the applications circuit on page 4, R_{BIAS} compensates for voltage and current variation over temperature.

Basic Application Circuit

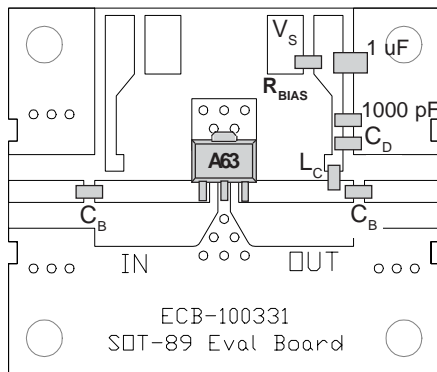
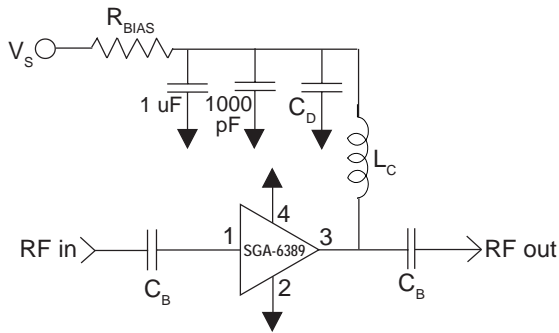

Part Identification Marking

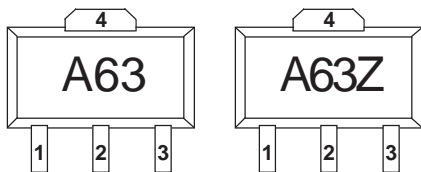

Caution: ESD sensitive
Appropriate precautions in handling, packaging and testing devices must be observed.

**See Application Note AN-075
for Package Outline Drawing**

Application Circuit Element

| Reference Designator | Frequency (Mhz) | | | | |
|----------------------|-----------------|--------|-------|-------|-------|
| | 500 | 850 | 1950 | 2400 | 3500 |
| C _B | 220 pF | 100 pF | 68 pF | 56 pF | 39 pF |
| C _D | 100 pF | 68 pF | 22 pF | 22 pF | 15 pF |
| L _C | 68 nH | 33 nH | 22 nH | 18 nH | 15 nH |

Recommended Bias Resistor Values for I_b=80mA

$$R_{BIAS} = (V_S - V_D) / I_b$$

| Supply Voltage (V _S) | 6 V | 8 V | 10 V | 12 V |
|----------------------------------|------|------|------|------|
| R _{BIAS} | 13 Ω | 39 Ω | 62 Ω | 91 Ω |

Note: R_{BIAS} provides DC bias stability over temperature.

Mounting Instructions

1. Solder the copper pad on the backside of the device package to the ground plane.
2. Use a large ground pad area with many plated through-holes as shown.
3. We recommend 1 or 2 ounce copper. Measurements for this data sheet were made on a 31 mil thick FR-4 board with 1 ounce copper on both sides.

| Pin # | Function | Description |
|-------|-----------------|---|
| 1 | RF IN | RF input pin. This pin requires the use of an external DC blocking capacitor chosen for the frequency of operation. |
| 2, 4 | GND | Connection to ground. For optimum RF performance, use via holes as close to ground leads as possible to reduce lead inductance. |
| 3 | RF OUT/ BIAS | RF output and bias pin. DC voltage is present on this pin, therefore a DC blocking capacitor is necessary for proper operation. |

Part Number Ordering Information

| Part Number | Reel Size | Devices/Reel |
|------------------|------------|--------------|
| SGA-6389 | 13" | 3000 |
| SGA-6389Z | 13" | 3000 |