

TENTATIVE TOSHIBA BIPOLAR LINEAR INTEGRATED CIRCUIT SILICON MONOLITHIC

TA1310AN

NTSC VIDEO, CHROMA, DEFLECTION, AND DISTORTION COMPENSATION IC (WITH YUV INTERFACE AND ACB)

TA1310AN is Video Chroma and deflection signal.
Processing IC for NTSC. On a 56-pin shrink DIP package.
TA1310AN has deflection distortion compensation.
TA1310AN uses an I²C Bus controls for controllings and
settings.

FEATURES

Video Signal Processing

- Built-in Y delay line
- Black stretch
- DC restoration ratio compensation
- Aperture controlled sharpness
- Output for velocity scan modulation (VSM)
- White peak suppression (WPS)

Chroma Signal Processing

- Built-in chroma BPF/TOF
- R-Y and B-Y outputs
- Color/BW situation output by read bus

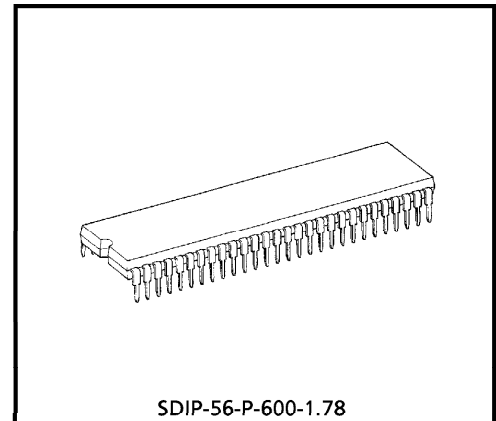

Weight : 5.55 g (Typ.)

980910EBA1

- TOSHIBA is continually working to improve the quality and the reliability of its products. Nevertheless, semiconductor devices in general can malfunction or fail due to their inherent electrical sensitivity and vulnerability to physical stress. It is the responsibility of the buyer, when utilizing TOSHIBA products, to observe standards of safety, and to avoid situations in which a malfunction or failure of a TOSHIBA product could cause loss of human life, bodily injury or damage to property. In developing your designs, please ensure that TOSHIBA products are used within specified operating ranges as set forth in the most recent products specifications. Also, please keep in mind the precautions and conditions set forth in the TOSHIBA Semiconductor Reliability Handbook.
- The products described in this document are subject to the foreign exchange and foreign trade laws.
- The information contained herein is presented only as a guide for the applications of our products. No responsibility is assumed by TOSHIBA CORPORATION for any infringements of intellectual property or other rights of the third parties which may result from its use. No license is granted by implication or otherwise under any intellectual property or other rights of TOSHIBA CORPORATION or others.
- The information contained herein is subject to change without notice.

Sync Signal Processing

- Counts down $32 f_H$
- Dual AFC
- Vertical AGC
- HD and VD outputs
- Vertical frequency fixed mode
- Horizontal and Vertical position alignment
- DC outputs for vertical centering

Text Signal Processing

- Analog RGB inputs
- Digital RGB inputs
- Halftone switch (Y_M)
- Cutoff and drive alignment
- YUV inputs
- ACB

Deflection Correction Function

- Horizontal and Vertical amplitude adjustment
- Vertical linearity correction
- Vertical S correction
- Vertical EHT correction
- E/W parabola correction
- E/W corner correction
- E/W trapezium correction

BLOCK DIAGRAM

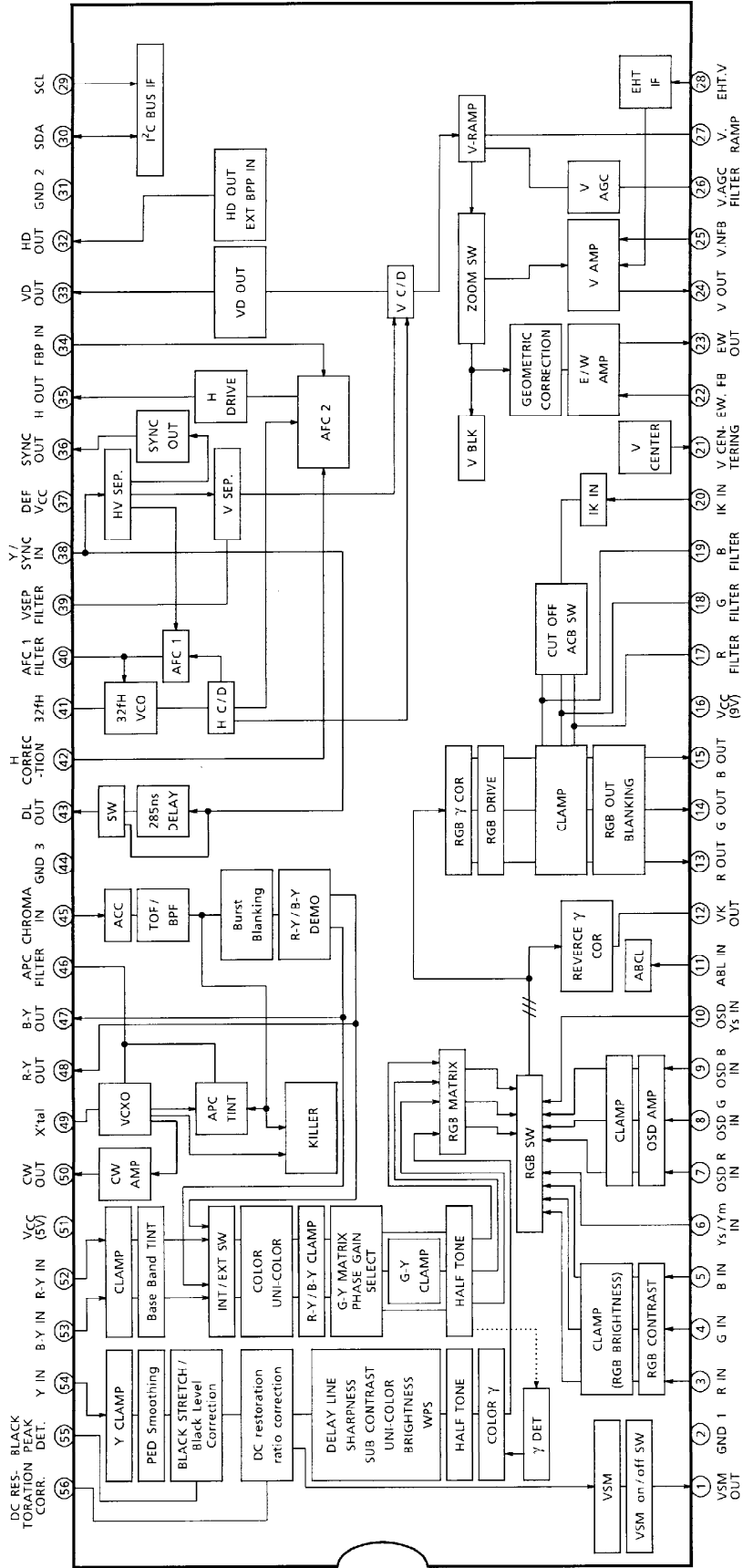

TA1310AN-3

BUS CONTROL MAP

Slave address : 88H (WRITE) / 89H (READ)

	D7	D6	D5	D4	D3	D2	D1	D0
00	ABL POINT		UNI-COLOR					
01	TEST	BRIGHTNESS						
02	Y-MUTE	COLOR						
03	TINT							TOF-SW
04	SHARPNESS						ABL GAIN	
05	RGB BRIGHTNESS				VERTICAL POSITION			UV-SW
06	G DRIVE GAIN							V-AGC
07	B DRIVE GAIN							VSM-G
08	R CUT OFF							
09	G CUT OFF							
0A	B CUT OFF							
0B	HORIZONTAL POSITION					B. S. POINT		
0C	VERTICAL SIZE						ZOOM	SERVICE
0D	HORIZONTAL SIZE						HV-FIX	
0E	E / W PARABOLA					V-S CORRECTION		
0F	V-LIN CORRECTION				SUB CONTRAST			
10	E / W TRAPEZIUM				E / W CORNER			
11	COL- γ	ACB MODE		V-BLK START PHASE				
12	RY / GY PHASE / GAIN		DL- MODE	V-BLK STOP PHASE				
13	VERTICAL CENTERING							RGB- γ
14	V CENTERING DAC SW	BASE BAND TINT						

READ MODE

	PORES	Y-IN	RGB-OUT	H-OUT	V-OUT	EW-OUT	COLOR	ED2
--	-------	------	---------	-------	-------	--------	-------	-----

The preset value for D7 is 1. The preset values for D0 to D6 are 0.

BUS CONTROL CHARACTERISTICS BY FUNCTION

Write mode

ITEM	DATA	No. OF BITS	PRESET VALUE
Unicolor (UNI-COLOR) / RGB Contrast	000000 ; -18dB 111111 ; 0 dB	6	-18 dB (000000)
Brightness (sub-brightness included) (BRIGHTNESS)	0000000 ; -40 (IRE) 1111111 ; +40 (IRE)	7	-40 (IRE) (0000000)
Color (sub-color included) (COLOR)	0000000 ; -∞ 1111111 ; +6 dB	7	-∞ (0000000)
Tint (sub-tint included) (TINT)	0000000 ; -32° 1111111 ; +32°	7	±0° (1000000)
Picture Sharpness (PICTURE-SHARPNESS)	000000 ; -6 dB 111111 ; +12 dB (at 2.4 MHz)	6	+6 dB (100000)
Sub Contrast (SUB-CONTRAST)	0000 ; -3 dB 1111 ; +3 dB	4	-3 dB (0000)
DC Output for Vertical Centering (VERTICAL CENTERING)	0000000 ; 1.0 V 1111111 ; 4.0 V	7	Center (1000000)
External/Internal Color Difference Switching (UV-SW)	0 ; INT 1 ; EXT	1	INT (0)
RGB Brightness (RGB-BRIGHTNESS)	0000 ; -20 (IRE) 1111 ; +20 (IRE)	4	Center (1000)
RGB Cut Off (RGB-CUTOFF)	00000000 ; -0.5 V 11111111 ; +0.5 V - At bus control - 00000000 ; 0.5 V _{p-p} 11111111 ; 1.5 V _{p-p} - IK input amplitude in ACB mode -	8×3	-0.5 V (00000000)
G/B Drive Gain (GB-DRIVE GAIN)	0000000 ; -5 dB 1111111 ; +3 dB	7×2	Center (1000000)
VSM Gain (VSM-G)	0 ; ON 1 ; OFF	1	ON (0)
Zoom Mode Switching (ZOOM)	0 ; Normal 1 ; ZOOM	1	normal (0)
Black Stretching Start Point (B.S. POINT)	000 ; Min/black stretch off (black correction on) 111 ; MAX/50 (IRE)	3	Black stretch OFF (000)
ABL Detection Voltage (ABL POINT)	00 ; MIN 11 ; MAX	2	Center (10)
ABL Sensitivity (ABL GAIN)	00 ; MIN 11 ; MAX	2	MIN (00)
Horizontal Position (HORIZONTAL POSITION)	00000 ; -3 μs (left shift) 11111 ; +3 μs	5	Center (10000)
Horizontal and Vertical Frequency Fixed Mode (HV-FIX)	00/01 ; normal 10 ; AFC OFF (Free run) & V = 263 (H) 11 ; AFC OFF (Free run) & V = 262.5 (H)	2	normal (00)
Vertical Pulse Phase (VERTICAL-PULSE PHASE)	000 ; 0H 111 ; 7H DELAY	3	0 (H) (000)
Service Mode (SERVICE)	0 ; normal 1 ; Service mode (V-Stop)	1	normal (0)
Test Mode (TEST MODE)	1 ; normal 0 ; RGB BLK OFF	1	normal (1)

ITEM	DATA	No. OF BITS	PRESET VALUE
TOF Switching (TOF-SW)	0 ; BPF mode 1 ; TOF mode	1	BPF (0)
V-AGC Time Constant (V-AGC)	0 ; fast 1 ; slow	1	fast (0)
Vertical Amplitude (VERTICAL SIZE)	000000 ; MIN 111111 ; MAX	6	Center (100000)
Vertical Linearity Correction (V-LIN CORRECTION)	0000 ; Lower stretch 1111 ; Upper stretch	4	Center (1000)
Vertical S Correction (V-S CORRECTION)	000 ; Reverse S MAX 111 ; S MAX	3	(000)
Horizontal Amplitude (HORIZONTAL SIZE)	000000 ; MAX 111111 ; MIN	6	Center (100000)
E/W Parabola Correction (E/W PARABOLA)	00000 ; MIN 11111 ; MAX	5	Center (10000)
E/W Corner Correction (E/W CORNER)	0000 ; Vertical expansion 1111 ; Vertical compression	4	(0000)
E/W Trapezium Correction (E/W TRAPEZIUM)	0000 ; Expansion upward 1111 ; Expansion downward	4	Center (1000)
Color γ Correction (COL- γ)	0 ; ON 1 ; OFF	1	OFF (1)
Y Mute (Y MUTE)	0 ; OFF 1 ; ON	1	ON (1)
RGB γ Correction (RGB- γ)	0 ; OFF 1 ; ON	1	OFF (0)
DL Mode Switching (DL-MODE)	0 ; Through 1 ; ON	1	Through (0)
ACB Mode Switching (ACB-MODE)	00 ; ACB OFF & S/H LOW 01 ; ACB OFF (Bus control) 10 ; ACB ON & I-DET normal 11 ; ACB ON & I-DET $\times 3$	2	S/H LOW (00)
Relative Phase Amplitude Switching (RY/GY PHASE/GAIN)	00 ; NTSC STD 01 ; DVD STD 10 ; NTSC (T) 11 ; A-TV STD	2	TSB STD (10)
Vertical Blanking Start Phase (V-BLK START PHASE)	00000 ; Vth (Hi) 11111 ; Vth (Lo)	5	(00000)
Vertical Blanking Stop Phase (V-BLK STOP PHASE)	00000 ; Vth (Lo) 11111 ; Vth (Hi)	5	(00000)
Base Band Tint	0000000 ; +60 deg 1111111 ; -40 deg *1000000 (Center) : +6 deg	7	Center (1000000)
V Centering DAC Output switch (V Centering DAC SW)	0 ; Interlocking E/W trapezium correction (E/W trapezium correction : $\pm 12.5\%$) 1 ; Non-interlocking E/W trapezium correction (E/W trapezium correction : $\pm 4.5\%$)	1	Non-interlocking (1)

READ MODE

Slave address : 89H

D7	D6	D5	D4	D3	D2	D1	D0
PONRES	Y-IN	RGB-OUT	H-OUT	V-OUT	EW-OUT	COLOR	ED2

ITEM	DATA	
Power On Reset (PORES)	0 ; Normal	1 ; Resister preset
Color Mode (COLOR)	0 ; B / W	1 ; NTSC
Self Diagnosis Result Output (RGB-OUT / Y-IN / H-OUT / V-OUT / E-W OUT / UV-IN)	0 ; NG	1 ; OK
ED2 Indentification	0 ; non-ED2	1 ; ED2

I²C BUS COMMUNICATIONS, RECEIVE METHOD

Start and stop condition

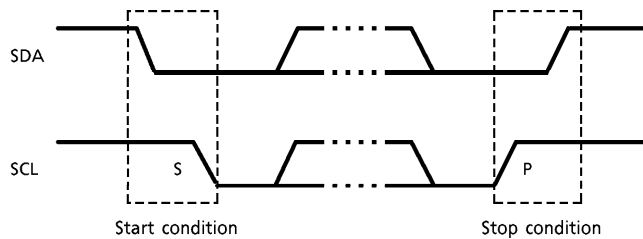

Bit transfer

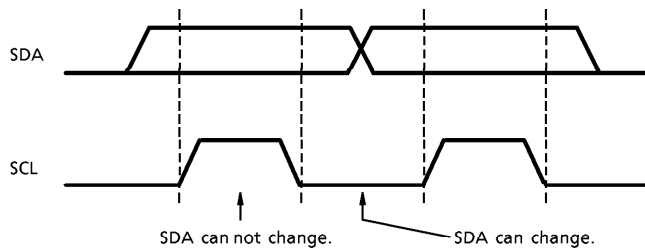

Acknowledgement

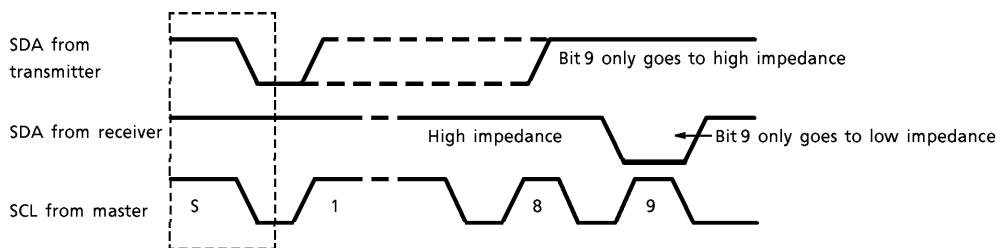

Data receive format

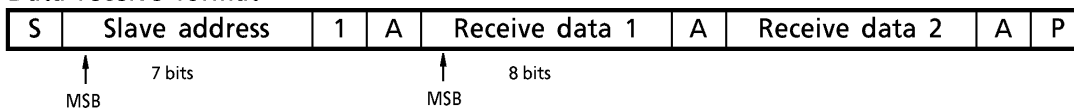

When data are received, the master transmitter changes to a receiver immediately after the first acknowledgement and the slave receiver changes to a transmitter.

The master always creates the stop condition.

Details are provided in the Philips I²C specifications.

Option data transmit format

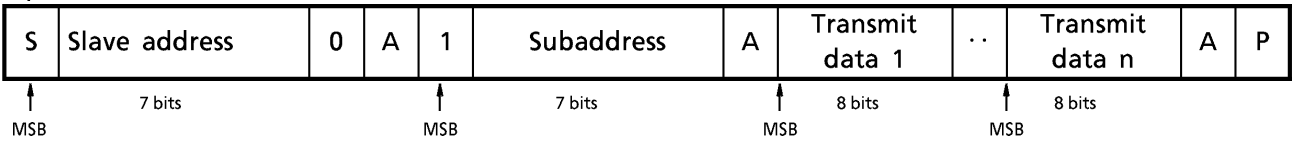

In the above method, the subaddresses are automatically incremented from the specified subaddress and data are set.

Purchase of TOSHIBA I²C components conveys license under the Philips I²C patent Rights to use these components in an I²C system, provided that the system conforms to the I²C standard specification as defined by Philips.

MAXIMUM RATINGS (Ta = 25°C)

CHARACTERISTICS	SYMBOL	RATING	UNIT
Power Supply Voltage (5 V / 9 V)	V _{CCmax}	7 / 12	V
Input Signal Voltage (5 V / 9 V)	e _{inmax}	5 / 9	V _{p-p}
Power Dissipation (Note)	P _D	1920	mW
Power Dissipation Reduction Rate	1 / Q _{ja}	15.4	mW / °C
Operating Temperature	T _{opr}	- 20 ~ 65	°C
Storage Temperature	T _{stg}	- 55 ~ 150	°C

(Note) : See the figure below.

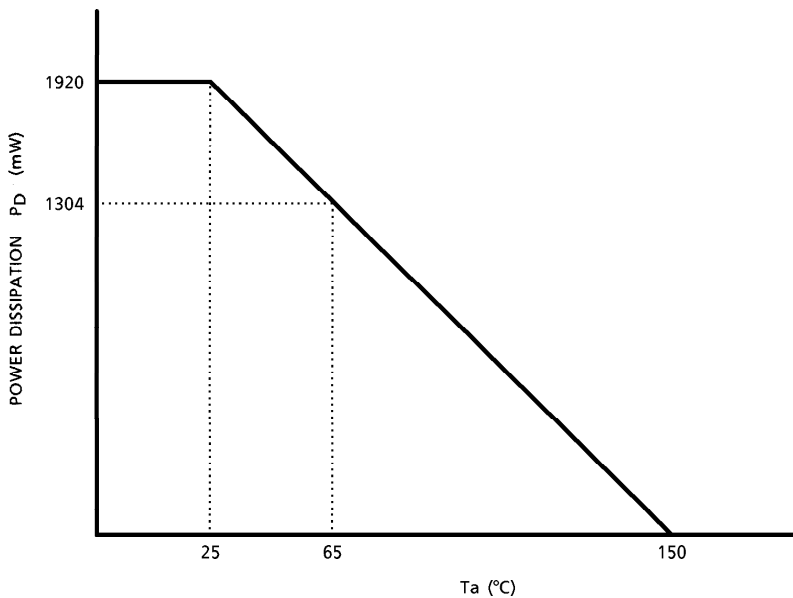

Fig. Temperature reduction curve for power dissipation

RECOMMENDED OPERATING POWER SUPPLY VOLTAGE

ITEM	DATA AND CONDITIONS	MIN	TYP.	MAX	UNIT
Power Supply Voltage	Pin 16, Pin 37	8.7	9.0	9.3	V
	Pin 51	4.8	5.0	5.2	
Pin 54 Y Input Signal Level	100% white, including synchronization	0.9	1.0	1.1	V _{p-p}
Pin 45 Chroma Input Signal Level	TOF : off, burst level	100	300	400	mV _{p-p}
	TOF : on, burst level	100	300	400	
Pin 38 Sync Signal Input Level	100% white, including synchronization	0.9	1.0	1.1	V _{p-p}

(Note) : Be sure to design the power supply so that when the power is Off, DEF V_{CC} is below 1.9 V.

ELECTRICAL CHARACTERISTICS

(V_{CC} = 5 V/9 V, DEF V_{CC} = 9 V, Ta = 25°C ± 3°C, unless otherwise specified)

Current dissipation

PIN NAME	SYMBOL	TEST CIR-CUIT	CURRENT DISSIPATION			UNIT	REMARKS
			MIN	TYP.	MAX		
5 V V _{CC}	I _{CC1}	—	32.50	38.34	45.30	mA	—
9 V V _{CC}	I _{CC2}	—	48.54	57.44	67.78	mA	—
DEF V _{CC}	I _{CC3}	—	19.70	23.31	27.50	mA	—

DC CHARACTERISTICS

Pin voltage

PIN	PIN NAME	SYM-BOL	MIN	TYP.	MAX	UNIT	PIN	PIN NAME	SYM-BOL	MIN	TYP.	MAX	UNIT
1	VSM out	V ₁	4.10	4.30	4.50	V	29	SCL	V ₂₉	4.90	5.00	—	V
2	GND1	V ₂	—	0.00	—		30	SDA	V ₃₀	4.90	5.00	—	
3	R in	V ₃	3.40	3.70	4.00		31	D. GND GND2	V ₃₁	—	0.00	—	
4	G in	V ₄	3.40	3.70	4.00		32	HD out	V ₃₂	0.15	0.20	0.25	
5	B in	V ₅	3.40	3.70	4.00		33	VD out	V ₃₃	4.90	5.00	5.10	
6	Ys/Ym in	V ₆	—	0.00	0.20		34	FBP in	V ₃₄	1.30	1.60	1.90	
7	OSD R in	V ₇	5.00	5.50	6.00		35	H out	V ₃₅	1.50	1.80	2.10	
8	OSD G in	V ₈	5.00	5.50	6.00		36	Sync out	V ₃₆	8.80	9.00	—	
9	OSD B in	V ₉	5.00	5.50	6.00		37	DEF VCC	V ₃₇	—	9.00	—	
10	OSD Ys in	V ₁₀	—	0.00	0.20		38	Sync in	V ₃₈	2.80	3.00	3.20	
11	ABL in	V ₁₁	5.70	6.00	6.30		39	V Sep	V ₃₉	6.00	6.40	6.80	
12	VK out	V ₁₂	4.85	5.00	—		40	AFC1	V ₄₀	7.20	7.50	7.80	
13	R out	V ₁₃	1.20	1.60	2.00		41	32 fh VCO	V ₄₁	5.70	5.90	6.10	
14	G out	V ₁₄	1.20	1.60	2.00		42	Curve correction	V ₄₂	4.60	4.80	5.00	
15	B out	V ₁₅	1.20	1.60	2.00		43	DL out	V ₄₃	0.30	0.80	1.00	
16	VCC (9 V)	V ₁₆	—	9.00	—		44	GND3	V ₄₄	—	0.00	—	
17	R Filter	V ₁₇	2.1	2.5	2.9		45	Chroma in	V ₄₅	1.59	1.77	1.95	
18	G Filter	V ₁₈	2.1	2.5	2.9		46	APC	V ₄₆	1.39	1.72	2.05	
19	B Filter	V ₁₉	2.1	2.5	2.9		47	B-Y out	V ₄₇	1.91	2.22	2.53	
20	IK in	V ₂₀	0.95	1.00	1.05		48	R-Y out	V ₄₈	1.91	2.22	2.53	
21	V Centering	V ₂₁	2.20	2.30	2.40		49	X'tal	V ₄₉	3.80	4.00	4.20	
22	EW FB	V ₂₂	3.90	4.30	4.70		50	CW out	V ₅₀	3.00	3.50	4.00	
23	EW out	V ₂₃	0.60	0.70	0.80		51	VCC (5 V)	V ₅₁	—	5.00	—	
24	V out	V ₂₄	0.60	0.70	0.80		52	R-Y in	V ₅₂	2.85	3.00	3.15	
25	V NFB	V ₂₅	4.60	5.00	5.40		53	B-Y in	V ₅₃	2.85	3.00	3.15	
26	V AGC	V ₂₆	1.80	2.00	2.20		54	Y in	V ₅₄	3.50	3.65	3.90	
27	V RAMP	V ₂₇	4.00	4.20	4.40		55	Black peak detect	V ₅₅	3.20	3.70	3.80	
28	EHT, V in	V ₂₈	4.80	4.90	5.00		56	DC restoration correction	V ₅₆	2.90	3.00	3.10	

AC CHARACTERISTICS

Video stage

CHARACTERISTICS	SYMBOL	TEST CIRCUIT	TEST CONDITIONS	MIN	TYP.	MAX	UNIT
#54 Voltage (Y Input Pedestal Clamp Voltage)	V54	—	(Note P1)	3.5	3.65	3.9	V
#55 Voltage	V55	—	(Note P2)	3.2	3.7	3.8	V
#56 Voltage	V56	—	(Note P3)	2.93	3.03	3.13	V
#1 Voltage	V1	—	(Note P4)	4.1	4.25	4.4	V
Y Input Pedestal Clamp Error Voltage	$\Delta VPC0$	—	(Note P5)	-7	± 0	+7	mV
	$\Delta VPC1$	—					
Y Input Pedestal Clamp Pulse Phase	TCL1	—	(Note P6)	2.8	2.9	3.0	μs
	TCL2	—		4.8	4.9	5.0	
Y Input Dynamic Range	DR54	—	(Note P7)	1.0	1.25	1.4	V _{p-p}
#56 Output Impedance	Z56	—	(Note P8)	4	5	6	k Ω
Black Stretching Amplifier Maximum Gain	GBS	—	(Note P9)	1.3	1.4	1.5	(Times)
Black Level Compensation	BLC	—	(Note P10)	6	7	8	(IRE)
Black Peak Detection Level	ΔVBP	—	(Note P11)	-15	0	+15	mV
Black Stretching Start Point	PB001	—	(Note P12)	34	36	42	(IRE)
	PB111	—		51	54	61	
DC Restoration Rate Compensation Amp. Gain	GDTC	—	(Note P13)	1.45	1.55	1.65	(Times)
	GDTR	—		1.3	1.4	1.5	
Self-Diagnosis Y IN	SCDC	—	(Note P14)	—	OK	—	—
	SCAC	—					
Y Mute	GYM	—	(Note P15)	$-\infty$	-50	-45	dB
Sharpness Peak Frequency	FAP	—	(Note P16)	3.35	4.2	5.05	MHz
Sharpness Control Range	GMAX	—	(Note P17)	8	11	14	dB
	GMIN	—		-12	-7.5	-3	
Sharpness Control Center Characteristics	GCEN	—	(Note P18)	2	5	8	dB
Between Y IN and R OUT Delay Time	TY	—	(Note P19)	120	150	180	ns
VSM Peak Frequency	FVSM	—	(Note P20)	3	4	5	MHz
VSM Gain	GVSM0	—	(Note P21)	9	11	13	dB
	GVSM1	—		$-\infty$	-30	-20	
VSM Muting Threshold Voltage	VVM10	—	(Note P22)	0.7	0.8	0.9	V
	VVM6	—		2.15	2.25	2.35	
VSM High Speed Muting Response Time	THM1	—	(Note P23)	0	+50	+100	ns
	THM2	—					
	THM3	—					
	THM4	—					
VSM Phase	TVM24	—	(Note P24)	64	80	94	ns
	TVMFP	—		59	73	87	
	TVM2T	—		64	80	94	

(Note 1) : For testing, see the picture sharpness test circuit diagrams.

(Note 2) : Ensure the composite signal is always input to pin 38 (SYNC IN).

Chroma stage

CHARACTERISTICS	SYMBOL	TEST CIR-CUIT	TEST CONDITIONS	MIN	TYP.	MAX	UNIT
ACC Characteristic	va10	—	(Note C1)	93.5	110	127	mV _{p-p}
	va30	—		272	320	368	
	va300	—		276	325	374	
	va600	—		276	325	374	
	A	—		0.80	1.00	1.10	—
Color Difference Output Level	vB	—	(Note C2)	276	325	374	mV _{p-p}
	vR	—		276	325	374	
Color Difference Output Relative Amplitude	vRB	—	(Note C3)	0.90	1.00	1.10	—
Color Difference Output Demodulation Angle	θ Bcnt	—	(Note C4)	3.0	6.0	11.0	°
	θ Rcnt	—		91.0	94.0	99.0	
Color Difference Output Relative Phase	θ RB	—	(Note C5)	85.0	89.0	91.0	°
Color Difference Output Tint Adjustment Characteristics	θ Bmax	—	(Note C6)	-35.0	-40.0	-46.5	°
	θ Bmin	—		35.0	38.0	44.0	
	θ Rmax	—		-35.0	-40.0	-46.5	
	θ Rmin	—		35.0	38.0	46.0	
Supply Voltage Dependence of Color Difference Output	BVp	—	(Note C7)	5.00	8.00	11.00	%
	RVp	—		5.00	8.00	11.00	
	BVn	—		-11.00	-8.00	-5.00	
	RVn	—		-11.00	-8.00	-5.00	
Identification Sensitivity	vCB	—	(Note C8)	3.00	4.10	6.00	mV _{p-p}
	vBC	—		3.00	4.40	6.00	
Bus Read Identification	bCB	—	(Note C9)	—	0	—	—
	bBC	—		—	1	—	
Color Difference Output Voltage Difference in 1H Period	vBH	—	(Note C10)	—	0	4.00	mV _{p-p}
	vRH	—		—	0	4.00	
Color Difference Output Voltage Difference Every 1H Period	vBG	—	(Note C11)	—	0	2.00	mV _{p-p}
	vRG	—		—	0	2.00	
Color Difference Output DC Voltage	VB	—	(Note C12)	1.91	2.22	2.53	V
	VR	—		1.91	2.22	2.53	
Difference between DC Voltage Axes of Color Difference Output	VRB	—	(Note C13)	-0.1	0	+0.1	V
X'tal Free-Run Frequency	Xf	—	(Note C14)	3.579345	3.579545	3.579745	MHz
APC Frequency Control Sensitivity	β f	—	(Note C15)	0.45	0.90	1.20	$\frac{\text{Hz}}{\text{mV}}$
APC Pull-In / Hold Range	fh +	—	(Note C16)	+250	+500	+2000	Hz
	fh -	—		-250	-500	-2000	
	fp +	—		+250	+500	+2000	
	fp -	—		-250	-500	-2000	
Residual Carrier Level	vBNo	—	(Note C17)	—	2.0	4.00	mV _{p-p}
	vRNo	—		—	2.0	4.00	
Residual Higher Harmonics Level	vBHn	—	(Note C18)	—	2.0	4.0	mV _{p-p}
	vRHn	—		—	2.0	4.0	

CHARACTERISTICS	SYMBOL	TEST CIR-CUIT	TEST CONDITIONS	MIN	TYP.	MAX	UNIT
TOF-BPF Characteristic	GBL	—	(Note C19)	17.5	21.0	24.5	dB
	GBH	—		21.5	25.0	28.5	
	GTL	—		14.0	17.5	21.0	
	GTH	—		21.5	25.0	28.5	
CW Output Amplitude	vCW	—	(Note C20)	420	700	980	mV _{p-p}

Color difference stage

CHARACTERISTICS	SYMBOL	TEST CIR-CUIT	TEST CONDITIONS	MIN	TYP.	MAX	UNIT
Color Difference Input Clamp Voltage	VRY	—	(Note A1)	2.85	3.00	3.15	V
	VBY	—		2.85	3.00	3.15	
Color Difference Input / Output Delay Time	DLRY	—	(Note A2)	115	150	185	ns
	DLBY	—		115	150	185	
Unicolor Adjustment Characteristics	uR	—	(Note A3)	-17	-19	-21	dB
	uB	—		-17	-19	-21	
Color Adjustment Characteristics	cRmax	—	(Note A4)	6.5	8.0	9.5	dB
	cRmin	—		—	—	-20	
	cBmax	—		6.5	8.0	9.5	
	cBmin	—		—	—	-20	
RGB Output Half-Tone Characteristics	vRHo	—	(Note A5)	-5.5	-6	-6.5	dB
	vGHo	—		-5.5	-6	-6.5	
	vBHo	—		-5.5	-6	-6.5	
RGB Output Amplitude	vRSTD	—	(Note A6)	0.64	1.13	0.87	V _{p-p}
	vGSTD	—		0.39	0.50	0.53	
	vBSTD	—		1.14	1.35	1.56	
	vRDVD	—		0.90	1.07	1.23	
	vGDVD	—		0.51	0.61	0.70	
	vBDVD	—		1.14	1.35	1.56	
	vRTSB	—		0.78	0.92	1.06	
	vGTSB	—		0.34	0.41	0.47	
	vBTSB	—		1.14	1.35	1.56	
	vRDTV	—		0.98	1.13	1.34	
	vGDTV	—		0.34	0.41	0.47	
	vBDTV	—		1.14	1.35	1.56	
RGB Output Relative Amplitude	vRBSTD	—	(Note A7)	0.78	0.87	0.96	—
	vGBSTD	—		0.31	0.35	0.39	
	vRBDVD	—		0.72	0.80	0.88	
	vGBDVD	—		0.37	0.42	0.47	
	vRBTSB	—		0.62	0.69	0.76	
	vGBTSB	—		0.25	0.28	0.31	
	vRBDTV	—		0.78	0.87	0.96	
	vGBDTV	—		0.24	0.27	0.30	

CHARACTERISTICS	SYMBOL	TEST CIR-CUIT	TEST CONDITIONS	MIN	TYP.	MAX	UNIT
RGB Output Demodulation Angle	θ RSTD	—	(Note A8)	86.0	90	94	°
	θ GSTD	—		232.0	236	240.0	
	θ BSTD	—		-4	0	4	
	θ RDVD	—		86.0	90	94.0	
	θ GDVD	—		240	244	248	
	θ BDVD	—		-4	0	4	
	θ RTSB	—		88.0	92	96.0	
	θ GTSB	—		236.0	240	244.0	
	θ BTSB	—		-4	0	4	
	θ RDTV	—		86.0	90	94.0	
	θ GDTV	—		240.0	244	248.0	
θ BDTV	—	-4	0	4			
RGB Output Relative Phase	θ RBSTD	—	(Note A9)	92	96	100	°
	θ GBSTD	—		236	240	244	
	θ RBDVD	—		88	92	96	
	θ GBDVD	—		240	244	248	
	θ RBTSB	—		90	94	98	
	θ GBTSB	—		235	239	243	
	θ RBDTV	—		103	107	111	
θ GBDTV	—	239	243	247			
Color Difference EXT → INT Crosstalk	XEIR	—	(Note A11)	—	-50	-45	dB
	XEIG	—		—	-50	-45	
	XEIB	—		—	-50	-45	
Color Difference INT → EXT Crosstalk	XIER	—	(Note A12)	—	-50	-45	dB
	XIEG	—		—	-50	-45	
	XIEB	—		—	-50	-45	
Color γ Characteristic	C γ sp	—	(Note A13)	1.80	2.07	2.20	V

Y stage

CHARACTERISTICS	SYMBOL	TEST CIR-CUIT	TEST CONDITIONS	MIN	TYP.	MAX	UNIT
Sync Input~DL Output AC Gain	Gyoff	—	(Note Y1)	-0.30	-0.20	0.01	dB
	Gyon	—		-0.45	-0.35	0.01	
Sync Input~DL Output Frequency Gain	Gfyoff	—	(Note Y2)	-0.20	0.00	0.20	dB
	Gfyon			-3.00	-1.60	0.20	
Sync Input~DL Output Dynamic Range	VDoff	—	(Note Y3)	1.30	1.60	—	V _{p-p}
	VDon			1.30	1.60	—	
Sync Input~DL Output Transfer Characteristics	TYDL	—	(Note Y4)	300	350	410	ns

Text stage

CHARACTERISTICS	SYMBOL	TEST CIRCUIT	TEST CONDITIONS	MIN	TYP.	MAX	UNIT
AC Gain	GR	—	(Note T1)	3.2	3.80	4.55	Times
	GG	—		3.2	3.80	4.55	
	GB	—		3.2	3.80	4.55	
Frequency Characteristics	GfR	—	(Note T2)	—	-3.0	-6.0	dB
	GfG	—		—	-3.0	-6.0	
	GfB	—		—	-3.0	-6.0	
Unicolor Adjustment Characteristic	vuMAX	—	(Note T3)	0.59	0.74	0.88	V _{p-p}
	vuCNT	—		0.31	0.39	0.47	
	vuMIN	—		0.06	0.08	0.10	
	Δ vu	—		17	18.5	20	dB
Brightness Adjustment Characteristic	VbrMAX	—	(Note T4)	4.3	4.6	4.9	V
	VbrCNT	—		3.3	3.6	3.9	
	VbrMIN	—		2.3	2.6	2.9	
Brightness Control Sensitivity	Gbr	—	(Note T5)	14.2	16.3	18.7	mV
White Peak Slice Level	VWPS	—	(Note T6)	2.600	2.825	3.100	V _{p-p}
Black Peak Slice Level	VBPSR	—	(Note T7)	1.95	2.15	2.35	V
	VBPSG	—					
	VBPSB	—					
DC Restoration	TDCR	—	(Note T8)	—	0.0	50	mV
	TDCG	—					
	TDCB	—					
RGB Output S/N	N13	—	(Note T9)	—	-50	-45	dB
	N14	—					
	N15	—					
RGB Output Emitter-Follower Drive Current	I#13	—	(Note T10)	1.1	1.5	1.9	mA
	I#14	—					
	I#15	—					
RGB Output Temperature Coefficient	Δ t13	—	(Note T11)	-2.0	0.0	2.0	mV/°C
	Δ t14	—					
	Δ t15	—					
Half-Tone Characteristics	GHT	—	(Note T12)	0.45	0.5	0.55	Times
Half-Tone ON Voltage	VHT	—	(Note T13)	0.6	0.8	1.0	V
V-BLK Pulse Output Level	VVR	—	(Note T14)	0.5	1.0	1.5	V
	VVG	—					
	VVB	—					
H-BLK Pulse Output Level	VHR	—	(Note T15)	0.5	1.0	1.5	V
	VHG	—					
	VHB	—					
Blanking Pulse Delay Time	tdONR	—	(Note T16)	—	0.0	0.3	μ s
	tdONG	—					
	tdONB	—					
	tdOFFR	—		—	0.0	0.3	
	tdOFFG	—					
	tdOFFB	—					

CHARACTERISTICS	SYMBOL	TEST CIRCUIT	TEST CONDITIONS	MIN	TYP.	MAX	UNIT
Sub-Contrast Control Range	$\Delta vsu +$	—	(Note T17)	1.8	2.3	2.8	dB
	$\Delta vsu -$	—		-3.0	-3.5	-4.0	
RGB Output Voltage	V#13	—	(Note T18)	2.35	2.6	2.85	V
	V#14	—					
	V#15	—					
Cut-Off Voltage Control Range	CUT + R	—	(Note T19)	0.45	0.5	0.55	V
	CUT + G	—					
	CUT + B	—					
	CUT - R	—		-0.45	-0.5	-0.55	
	CUT - G	—					
	CUT - B	—					
Drive Adjustment Range	DRG +	—	(Note T20)	2.35	2.85	3.35	dB
	DRG -	—		-4.25	-5.0	-5.75	
	DRB +	—		2.35	2.85	3.35	
	DRB -	—		-4.25	-5.0	-5.75	
#11 Input Impedance	Zin11	—	(Note T21)	24	30	36	k Ω
ACL Characteristic	ACL1	—	(Note T22)	-1.5	-3.5	-5.5	dB
	ACL2	—		-12	-15	-18	
ABL Point	ABLP1	—	(Note T23)	0.04	-0.01	-0.06	V
	ABLP2	—		-0.09	-0.14	-0.19	
	ABLP3	—		-0.24	-0.29	-0.34	
	ABLP4	—		-0.37	-0.42	-0.47	
ABL Gain	ABLG1	—	(Note T24)	-0.119	-0.095	-0.072	V
	ABLG2	—		-0.400	-0.320	-0.240	
	ABLG3	—		-0.750	-0.600	-0.450	
	ABLG4	—		-0.925	-0.740	-0.555	
BLK Off Mode	BLK	—	(Note T25)	—	Operating	—	—
Analog RGB Gain	GTXR	—	(Note T26)	4.2	5.0	6.0	Times
	GTXG	—					
	GTXB	—					
Analog RGB Frequency Characteristics	GfTXR	—	(Note T27)	—	-1.0	-3.0	dB
	GfTXG	—					
	GfTXB	—					
Analog RGB Input Dynamic Range	GR13	—	(Note T28)	0.47	0.55	—	V _{p-p}
	GR14	—					
	GR15	—					
Analog RGB White Peak Slice Level	VTXMAXR	—	(Note T29)	3.5	3.8	4.1	V _{p-p}
	VTXMAXG	—					
	VTXMAXB	—					
Analog RGB Black Peak Limiter Level	VTXMINR	—	(Note T30)	1.9	2.1	2.3	V
	VTXMING	—					
	VTXMINB	—					

CHARACTERISTICS	SYMBOL	TEST CIRCUIT	TEST CONDITIONS	MIN	TYP.	MAX	UNIT
Analog RGB Contrast Adjustment Characteristics	vuTXR1	—	(Note T31)	0.85	1.0	1.2	V _{p-p}
	vuTXG1	—					
	vuTXB1	—					
	vuTXR2	—		0.50	0.59	0.71	
	vuTXG2	—					
	vuTXB2	—					
	vuTXR3	—		0.11	0.13	0.15	
	vuTXG3	—					
	vuTXB3	—					
	Δ vuTXR	—		17.0	18.5	20	dB
	Δ vuTXG	—					
Δ vuTXB	—						
Analog RGB Brightness Adjustment Characteristics	VbrTX1R	—	(Note T32)	3.3	3.6	3.9	V
	VbrTX1G	—					
	VbrTX1B	—		2.8	3.1	3.4	
	VbrTX2R	—					
	VbrTX2G	—					
	VbrTX2B	—		2.2	2.5	2.8	
	VbrTX3R	—					
	VbrTX3G	—					
VbrTX3B	—						
Analog RGB Mode On Voltage	VTXON	—	(Note T33)	2.0	2.25	2.5	V
Analog RGB Mode Transfer Characteristics	τ RYSR	—	(Note T34)	—	25	100	ns
	τ RYSG	—					
	τ RYSB	—					
	tPRYSR	—		—	30	100	
	tPRYSG	—					
	tPRYSB	—					
	Δ tPRYS	—		—	0	20	
	τ FYSR	—					
	τ FYSG	—					
	τ FYSB	—		—	10	100	
	tpFYSR	—					
	tpFYSG	—					
	tpFYSB	—		—	25	100	
	Δ tPFYS	—					
Crosstalk from Video to Analog RGB	V _v →aR	—	(Note T35)	—	- 50	- 45	dB
	V _v →aG	—					
	V _v →aB	—					
Crosstalk from Analog RGB to Video	V _a →vR	—	(Note T36)	—	- 55	- 50	dB
	V _a →vG	—					
	V _a →vB	—					

CHARACTERISTICS	SYMBOL	TEST CIRCUIT	TEST CONDITIONS	MIN	TYP.	MAX	UNIT
Analog OSD Gain	GOSDR	—	(Note T37)	1.8	2.0	2.2	(Times)
	GOSDG	—					
	GOSDB	—					
Analog OSD Frequency Characteristics	GfOSDR	—	(Note T38)	—	- 1.0	- 3.0	dB
	GfOSDG	—					
	GfOSDB	—					
Analog OSD Output Level	VOSD1R	—	(Note T39)	2.25	2.5	2.75	V
	VOSD1G	—					
	VOSD1B	—					
	VOSD2R	—					
	VOSD2G	—		1.98	2.20	2.42	
	VOSD2B	—					
	VOSD3R	—					
	VOSD3G	—		5.0	5.5	6.0	
VOSD3B	—						
Analog OSD Mode On Voltage	VOSDON	—	(Note T40)	2.00	2.25	2.50	V
Analog OSD Mode Transfer Characteristic	τ ROSDYSR	—	(Note T41)	—	20	100	ns
	τ ROSDYSG	—					
	τ ROSDYSB	—					
	tPROSDYSR	—		—	30	100	
	tPROSDYSG	—					
	tPROSDYSB	—					
	Δ tPROSDYS	—		—	0	20	
	τ FOSDYSR	—		—	15	100	
	τ FOSDYSG	—					
	τ FOSDYSB	—					
	tPFOSDYSR	—		—	30	100	
	tPFOSDYSG	—					
	tPFOSDYSB	—					
	Δ tPFOSDYS	—		—	0	20	
RGB Output Self-Diagnosis	SCRGB	—	(Note T42)	—	Operating	—	—
ACB Input Pulse Phase, Amplitude	θ ACBR	—	(Note T43)	—	1	—	(H)
	θ ACBG	—		—	2	—	
	θ ACBB	—		—	3	—	
	VACBR	—		0.200	0.250	0.300	V _{p-p}
	VACBG	—		0.200	0.250	0.300	
	VACBB	—		0.200	0.250	0.300	

CHARACTERISTICS	SYMBOL	TEST CIRCUIT	TEST CONDITIONS	MIN	TYP.	MAX	UNIT
ACB Clamp Current	I17a	—	(Note T44)	0.08	0.1	0.125	mA
	I17b	—		0.08	0.1	0.125	
	I17c	—		0.8	1.0	1.3	
	I17d	—		2.0	2.5	3.2	
	I18a	—		0.08	0.1	0.125	
	I18b	—		0.08	0.1	0.125	
	I18c	—		0.8	1.0	1.3	
	I18d	—		2.0	2.5	3.2	
	I19a	—		0.08	0.1	0.125	
	I19b	—		0.08	0.1	0.125	
	I19c	—		0.8	1.0	1.3	
	I19d	—		2.0	2.5	3.2	
IK Input Amplitude	IKR	—	(Note T45)	0.8	1.0	1.2	V _{p-p}
	IKG	—		0.8	1.0	1.2	
	IKB	—		0.8	1.0	1.2	
RGB γ Correction Characteristics	γ 1R	—	(Note T46)	40	50	60	(IRE)
	γ 2R	—		60	70	80	
	Δ 1R	—		0.75	1.5	2.25	dB
	Δ 2R	—		-0.75	0.0	0.75	
	Δ 3R	—		-2.55	-3.3	-4.05	
	γ 1G	—		40	50	60	(IRE)
	γ 2G	—		60	70	80	
	Δ 1G	—		0.75	1.5	2.25	dB
	Δ 2G	—		-0.75	0.0	0.75	
	Δ 3G	—		-2.55	-3.3	-4.05	
	γ 1B	—		40	50	60	(IRE)
	γ 2B	—		60	70	80	
	Δ 1B	—		0.75	1.5	2.25	dB
	Δ 2B	—		-0.75	0.0	0.75	
Δ 3B	—	-2.55	-3.3	-4.05			
VK Output Characteristic	VKA	—	(Note T47)	1.90	2.00	2.10	V _{p-p}
	VK1	—		25.0	35.00	45.0	
	VK2	—		60.0	70.00	80.0	
ACB Protector Circuit Operation Check 1	ACBPR	—	(Note T48)	—	—	—	—
	ACBPG	—		—	—	—	
ACB Protector Circuit Operation Check 2	ACBBRAR	—	(Note T49)	—	—	—	—
	ACBBRAG	—		—	—	—	
ACB Protector Circuit Operation Check 3	ACBBRLO	—	(Note T50)	—	—	—	—

CHARACTERISTICS	SYMBOL	TEST CIRCUIT	TEST CONDITIONS	MIN	TYP.	MAX	UNIT
Base Band TINT Adjustment Characteristics	ANG RMIN	—	(Note T51)	47.0	53.0	59.0	°
	ANG BMIN	—		47.0	53.0	59.0	
	ANG RMAX	—		- 51.0	- 45.0	- 39.0	
	ANG BMAX	—		- 51.0	- 45.0	- 39.0	
Base Band TINT Adjustment Position	BUS BO	—	(Note T52)	C2	C6	CA	HEX

Deflection stage

CHARACTERISTICS	SYMBOL	TEST CIR-CUIT	TEST CONDITIONS	MIN	TYP.	MAX	UNIT
Sync. Separation Input Sensitivity Current	I _{IN38}	—	(Note D1)	12	20	30	μA
V Separation Filter Pin Source Current	I _{OUT39}	—	(Note D2)	3.2	4.2	5.2	μA
V Separation Level	V _{SEP}	—	(Note D3)	5.0	5.5	6.0	V
H AFC Phase Detection Current Ratio	I _{DET}	—	(Note D4)	210	300	420	μA
	ΔI _{DET}	—		-5	0	+5	%
Phase Detection Stop Period	T _{CO40}	—	(Note D5)	—	262 5 10	—	(H)
32* f _H VCO Oscillation Start Voltage	V _{VCO}	—	(Note D6)	3.7	4.0	4.3	V
Horizontal Output Start Voltage	V _{HON35}	—	(Note D7)	4.7	5.0	5.3	V
	V _{BUS HON}	—		—	1	—	—
	V _{BUS HOFF}	—		—	0	—	—
Horizontal Output Pulse Duty	T _{H35}	—	(Note D8)	38.5	40.5	42.5	%
Phase Detection Stop Mode	f _{FR}	—	(Note D9)	15585	15734	15885	Hz
Horizontal Output Free-Run Frequency	f _{HO}	—	(Note D10)	15585	15734	15885	Hz
Horizontal Oscillation Frequency Range	f _{HMIN}	—	(Note D11)	14700	15000	15300	Hz
	f _{HMAX}	—		16500	16700	16900	
Horizontal Oscillation Control Sensitivity	β _H	—	(Note D12)	250	300	350	Hz / 0.1V
Horizontal Output Voltage	V _{H35}	—	(Note D13)	4.2	4.6	5.0	V
	V _{L35}	—		—	0.15	0.3	
Power Supply Voltage Dependence of Horizontal Oscillation Frequency	Δf _{HV}	—	(Note D14)	-20	0	+20	Hz / V
Temperature Dependence of Horizontal Oscillation Frequency	Δf _{HT}	—	(Note D15)	—	60	70	Hz
Horizontal Sync. Phase	S _{PH1}	—	(Note D16)	2.3	2.5	2.7	μs
	S _{PH2}	—		0.2	0.3	0.4	
Horizontal Picture Phase Adjustment Range	ΔH _{SFT}	—	(Note D17)	5.5	6.0	6.5	μs
Horizontal Blanking Pulse Threshold	V _{HBLK1}	—	(Note D18)	4.7	5.0	5.3	V
	V _{HBLK2}	—		0.8	1.1	1.4	
Curve Correction Characteristic	ΔH ₄₂	—	(Note D19)	2.3	2.5	2.7	μs
H Cycle Black Peak Detection Disable Pulse	HBP _S	—	(Note D20)	7.5	8.0	8.5	μs
	HBP _W	—		13.0	13.5	14.0	
External Black Peak Detection Disable Pulse Threshold	BPV ₃₂	—	(Note D21)	0.9	1.1	1.3	V

CHARACTERISTICS	SYMBOL	TEST CIRCUIT	TEST CONDITIONS	MIN	TYP.	MAX	UNIT
Clamp Pulse Start Phase	CP _S	—	(Note D22)	2.8	3.0	3.2	μs
Clamp Pulse Width	CP _W	—	(Note D22)	5.6	5.8	6.0	μs
HD Output Start Phase	HD _S	—	(Note D23)	0.7	0.9	1.1	μs
HD Output Pulse Width	HD _W	—	(Note D23)	0.7	0.9	1.1	μs
HD Output Amplitude	V _{HD}	—	(Note D23)	4.7	5.0	5.3	V
Gate Pulse Start Phase	GP _S	—	(Note D24)	2.7	2.9	3.1	μs
Gate Pulse Width	GP _W	—	(Note D24)	1.8	2.0	2.2	μs
Gate Pulse V Mask Period	T _{CO34}	—	(Note D25)	—	261 ∫ 10	—	(H)
Sync. Out Low Level	V _{SY}	—	(Note D26)	0.0	0.3	0.5	V
Vertical Output Oscillation Start Voltage	V _{ON}	—	(Note D27)	4.1	4.4	4.7	V
Vertical Free-Run Frequency	f _{VO}	—	(Note D28)	—	53	—	Hz
Vertical Output Voltage	V _{VH}	—	(Note D29)	4.9	5.2	5.5	V
	V _{VL}	—		—	0	0.3	
Service Mode Switching	VD _{NO}	—	(Note D30)	3.1	3.4	3.7	V
Vertical Pull-In Range	f _{PL}	—	(Note D31)	—	225	—	(H)
	f _{PH}	—		—	297	—	
Vertical Frequency Forced 263H	f _{V1}	—	(Note D32)	—	263	—	(H)
Vertical Frequency Forced 262.5H	f _{V2}	—	(Note D32)	—	262.5	—	(H)
Vertical Blanking Off Mode	V _{OFF}	—	(Note D33)	—	Check	—	—
Vertical Output Pulse Width	T _D	—	(Note D34)	44	46	48	μs
	T _W	—		—	8	—	
RGB Output Vertical Blanking Pulse Start Phase	VR _{S1}	—	(Note D35)	44	46	48	μs
	VG _{S1}	—					
	VB _{S1}	—					
RGB Output Vertical Blanking Pulse Stop Phase	VR _{S2}	—	(Note D35)	—	22	—	(H)
	VG _{S2}	—		—	22	—	
	VB _{S2}	—		—	22	—	
V Cycle Black Peak Detection Disable Pulse (Normal)	VBP _{NORMAL}	—	(Note D36)	—	257 ∫ 28	—	(H)
V Cycle Black Peak Detection Disable Pulse (Zoom)	VBP _{ZOOM}	—	(Note D37)	—	229 ∫ 56	—	(H)

Deflection correction stage

CHARACTERISTICS	SYMBOL	TEST CIRCUIT	TEST CONDITIONS	MIN	TYP.	MAX	UNIT
Vertical Ramp Amplitude	V _{P27}	—	(Note G1)	1.50	1.67	1.83	V _{p-p}
Vertical Amplification	G _V	—	(Note G2)	22	25	28	dB
Vertical Amp Maximum Output Voltage	V _{H24}	—	(Note G3)	2.5	3.0	3.5	V
Vertical Amp Minimum Output Voltage	V _{L24}	—	(Note G4)	—	0.0	0.3	V
Vertical Amp Maximum Output Current	I _{MAX1}	—	(Note G5)	11	14	17	mA
Vertical NF Sawtooth Wave Amplitude	V _{P25}	—	(Note G6)	1.50	1.67	1.83	V _{p-p}
Vertical Amplitude Range	V _{PH}	—	(Note G7)	± 36	± 40	± 44	%
Vertical Linearity Correction Maximum Value	V _ℓ	—	(Note G8)	± 12	± 15	± 18	%
Vertical S Correction Maximum Value	V _S	—	(Note G9)	20	25	30	%
Vertical NF Center Voltage	V _C	—	(Note G10)	4.8	5.0	5.2	V
Vertical NF DC Change	V _{DC}	—	(Note G11)	± 100	± 120	± 140	mV
Vertical Amplitude EHT Correction	V _{EHT}	—	(Note G12)	8	9	10	%
E-W NF Maximum DC Value (Picture Width)	V _{H22}	—	(Note G13)	5.3	5.8	6.3	V
E-W NF Minimum DC Value (Picture Width)	V _{L22}	—	(Note G14)	1.75	1.90	2.05	V
E-W NF Parabola Maximum Value (Parabola)	V _{PB}	—	(Note G15)	2.1	2.5	2.9	V _{p-p}
E-W NF Corner Correction (Corner)	V _{CR}	—	(Note G16)	1.0	1.2	1.4	V _{p-p}
Parabola Symmetry Correction	V _{TR}	—	(Note G17)	± 4.5	± 5.5	± 6.5	%
E-W Amp Maximum Output Current	I _{MAX2}	—	(Note G18)	0.14	0.20	0.28	mA
AGC Operating Current 1	V _{AGC0}	—	(Note G19)	470	590	710	μA
AGC Operating Current 2	V _{AGC1}	—	(Note G20)	100	130	160	μA
Vertical Guard Voltage	V _{VG}	—	(Note G21)	1.80	2.00	2.20	V
E / W Output Self-Diagnosis	V _{BUS EW_{OFF}}	—	(Note G22)	—	0	—	—
	V _{BUS EW_{ON}}	—		—	1	—	
V-Out Output Self-Diagnosis	V _{BUS V_{OFF}}	—	(Note G23)	—	0	—	—
	V _{BUS V_{ON}}	—		—	1	—	
Vertical Blanking Check	V _{BLK1} V _{BLK2}	—	(Note G24)	—	Check	—	—
V Centering DAC Output	V _{21L}	—	(Note G25)	0.20	0.25	0.30	V
	V _{21M}	—		2.20	2.30	2.35	
	V _{21H}	—		4.20	4.30	4.35	
V NFB Pin Input Current	I ₂₀	—	(Note G26)	—	10	900	nA

TEST CONDITIONS
Video stage

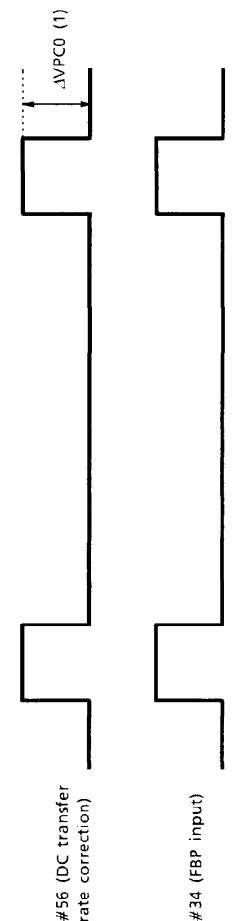
NOTE	ITEM	SW MODE		MEASUREMENT METHOD
		SW54	SW55 SW56	
P1	#54 Voltage (Y Input Pedestal Clamp Voltage)	C	OPEN OPEN	<ol style="list-style-type: none"> Set the bus control data to the preset value. Measure the #54 DC voltage V54.
P2	#55 Voltage	C	OPEN OPEN	<ol style="list-style-type: none"> Set the bus control data to the preset value. Measure the #55 DC voltage V55.
P3	#56 Voltage	C	OPEN OPEN	<ol style="list-style-type: none"> Set the bus control data to the preset value. Measure the #56 DC voltage V56.
P4	#1 Voltage	C	OPEN ON	<ol style="list-style-type: none"> Set the bus control data to the preset value. Measure the #1 DC voltage V1.
P5	Y Input Pedestal Clamp Error Voltage	C	OPEN OPEN	<ol style="list-style-type: none"> Set the bus control data to the preset value. Set SW54 to C (connect the Y input to AC-GND). Measure #56 with an oscilloscope as shown in the diagram and calculate ΔVPC. Calculate the voltage differences $\Delta VPC1$ and $\Delta VPC0$ when the Y mute is on (1) and off (0). 

(Note 1) : When testing, see the picture sharpness test circuit diagram. First turn ACB mode off (bus control).
 (Note 2) : Ensure the composite signal is always input to pin 38 (SYNC IN).

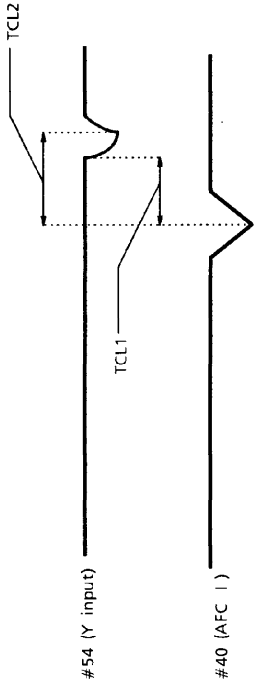
		(TEST CONDITIONS $V_{CC} = 9V/5V, T_a = 25 \pm 3^{\circ}C$)		MEASUREMENT METHOD
NOTE	ITEM	SW MODE	SW MODE	
		SW54	SW55 SW56	<ol style="list-style-type: none"> Set the bus control data to the preset value. Set SW54 to B (connect V_{CC} (5V) to the Y input via a 20-kΩ resistor). Measure #54 and #40 with an oscilloscope as shown in the diagram. Calculate TCL1 and TCL2.
P6	Y Input Pedestal Clamp Pulse Phase	B	B OPEN	
P7	Y Input Dynamic Range	C	B OPEN	<ol style="list-style-type: none"> Set the bus control data to the preset value. Set SW54 to C (connect the Y input to AC-GND). Set the unicolor to the center (100000), the brightness to the center (1000000), RGB cutoff to the center (1000000), the Y mute to OFF (0), and connect an external power supply to #54. Increase the supply voltage from V54 and measure #13 (ROUT). When the #13 voltage stops changing, substitute the supply voltage (V) in the formula below and calculate DR54. $DR54 = V - V54$

(Note 1) : When testing, see the picture sharpness test circuit diagram. First turn ACB mode off (bus control).

(Note 2) : Ensure the composite signal is always input to pin 38 (SYNC IN).

(TEST CONDITIONS $V_{CC} = 9V/5V, T_a = 25 \pm 3^\circ C$)			
NOTE	ITEM	MEASUREMENT METHOD	
		SW MODE SW ₅₄ SW ₅₅ SW ₅₆	
P8	#56 Output Impedance	C	<p>OPEN</p>
P9	Black Stretching Amplifier Maximum Gain	A ↓ B	<p>OPEN</p>

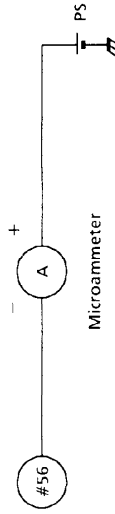

(Note 1) : When testing, see the picture sharpness test circuit diagram. First turn ACB mode off (bus control).
 (Note 2) : Ensure the composite signal is always input to pin 38 (SYNC IN).

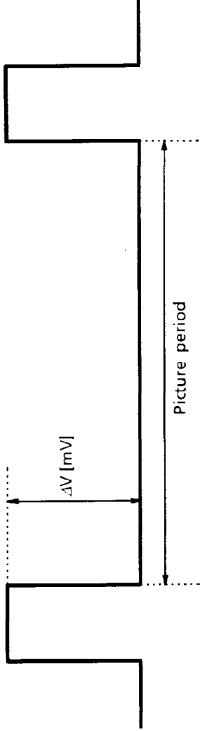
(TEST CONDITIONS $V_{CC} = 9V/5V$, $T_a = 25 \pm 3^{\circ}C$)		
NOTE	ITEM	MEASUREMENT METHOD
		SW MODE SW ₅₄ SW ₅₅ SW ₅₆
P10	Black Level Compensation	<p>① Set the bus control data to the preset value.</p> <p>② Set SW₅₄ to C (connect the Y input to AC-GND), set SW₅₅ to A (maximum gain), turn the Y mute off (0), and turn the black level compensation on (set the black stretch start point to 000).</p> <p>③ Observe #56, measure ΔV, and calculate the following formula.</p> $BLC [(IRE)] = (\Delta V [mV] \div (0.7 \times 10^3) [mV]) \times 100 [(IRE)]$ 
P11	Black Peak Detection Level	<p>① Set the bus control data to the preset value.</p> <p>② Turn the Y mute off (0) and connect #54 to an external power supply (PS).</p> <p>③ Turn the black level correction on (set the black stretch start point to 000).</p> <p>④ Increase the PS from 3V and measure the voltage VBP of #56 where the DC level of the picture period of #55 shifts from high to low.</p> <p>⑤ Calculate ΔVBP from the following formula.</p> $\Delta VBP = VBP - V56$

(Note 1) : When testing, see the picture sharpness test circuit diagram. First turn ACB mode off (bus control).
 (Note 2) : Ensure the composite signal is always input to pin 38 (SYNC IN).

NOTE		ITEM		SW MODE		MEASUREMENT METHOD	
				SW54	SW55	SW56	
P12	Black Stretching Start Point	C	B ↓ A			OPEN	<p>(TEST CONDITIONS $V_{CC} = 9V/5V$, $T_a = 25 \pm 3^\circ C$)</p> <ol style="list-style-type: none"> Set the bus control data to the preset value. Set SW54 to C (connect the Y input to AC-GND), set SW55 to B (minimum gain), turn the Y mute off (0), and set the black stretch start point to 001. Connect #54 to an external power supply (PS), increase the voltage from V54, and plot the resulting change in voltage S1 of #56. Next, set SW55 to A (maximum gain). Then, increase the voltage from V54 as in ③ above and plot the resulting change in voltage S2 of #56. Now set the black stretch point to 111 and plot S3 as in ③ above. Use the diagram below to calculate the intersection V_{B001} of S1 and S2, and the intersection V_{B111} of S1 and S3. Use the following formulas to calculate PB001 and PB111, and calculate PB001 [(IRE)] = $(V_{B001} [V] - V_{56} [V]) \div 0.7 [V] \times 100 [(IRE)]$ PB111 [(IRE)] = $(V_{B111} [V] - V_{56} [V]) \div 0.7 [V] \times 100 [(IRE)]$

(Note 1) : When testing, see the picture sharpness test circuit diagram. First turn ACB mode off (bus control).
 (Note 2) : Ensure the composite signal is always input to pin 38 (SYNC IN).

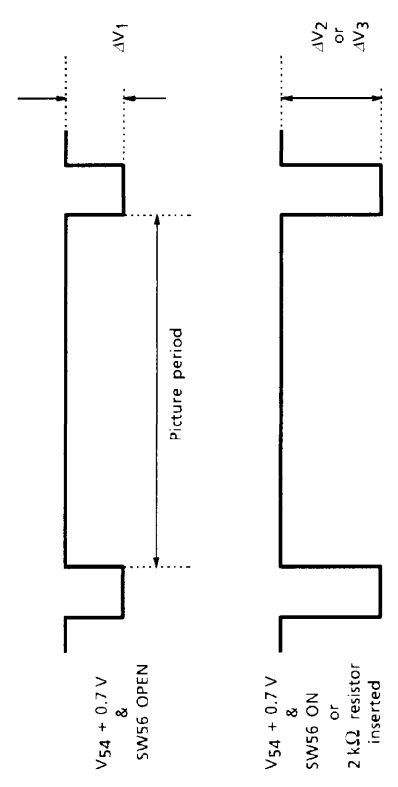
NOTE		ITEM		SW MODE		(TEST CONDITIONS $V_{CC} = 9\text{ V}/5\text{ V}$, $T_a = 25 \pm 3^\circ\text{C}$)	
						MEASUREMENT METHOD	
P13	DC Restoration Rate Compensation Amp Gain	C	B	SW54	SW55	SW56	<p>① Set the bus control data to the preset value.</p> <p>② Connect #54 to an external power supply (PS).</p> <p>③ Turn the Y mute off (0), set the unicolor to the center (100000), set the brightness to the center (1000000), set RGB cutoff to the center (10000000), and observe #13 (ROUT).</p> <p>④ Use unicolor to adjust the difference in the #13 picture period DC level to 0.7 V when the power supply is set to V_{54} and $V_{54} + 0.7\text{ V}$.</p> <p>⑤ Applying $V_{54} + 0.7\text{ V}$ to #54 as shown in the diagram below, calculate ΔV_1 of #13, then calculate ΔV_2 of #13 when SW56 is on.</p> <p>⑥ Connect a 2-kΩ resistor between #56 and C56 (1 μF) and calculate ΔV_3 of #13.</p> <p>⑦ Calculate GDTC and GDTR from the following formula.</p> <p style="text-align: center;">$\text{GDTC} = ((\Delta V_2 [\text{V}] - \Delta V_1 [\text{V}] + 0.7 [\text{V}]) \div 0.7 [\text{V}])$</p> <p style="text-align: center;">$\text{GDTR} = ((\Delta V_3 [\text{V}] - \Delta V_1 [\text{V}] + 0.7 [\text{V}]) \div 0.7 [\text{V}])$</p> 

(Note 1) : When testing, see the picture sharpness test circuit diagram. First turn ACB mode off (bus control).
 (Note 2) : Ensure the composite signal is always input to pin 38 (SYNC IN).

		(TEST CONDITIONS $V_{CC} = 9V/5V, T_a = 25 \pm 3^\circ C$)	
NOTE	ITEM	MEASUREMENT METHOD	
		SW MODE	
		SW54 SW55 SW56	
P14	Self-Diagnosis Y-IN	C ↓ A	OPEN
P15	Y Mute	A	B OPEN

① Set the bus control data to the preset value.

② Set SW54 to C (connect the Y input to AC-GND), connect #54 to an external power supply (PS), and turn read mode on.

③ When the power supply is increased from V54 to V54 + 0.7 V, check that in read mode Y-IN changes from error to OK to error. SCDC

④ Next, set SW54 to A and input a sine wave from TG-7 to TP54. Apply a signal on #54 as shown in the diagram. Check that there is no problem with the Y IN in read mode. SCAC

① Set the bus control data to the preset value.

② Input a 100-kHz sine wave to TP54 and adjust #54 to 0.7 V_{p-p}.

③ Turn the Y mute on (1) and measure the #56 amplitude VYM1.

④ Turn the Y mute off (0) and measure the #56 amplitude VYM0.

⑤ Calculate the following formula.

$GYM [dB] = 20 \times \log(VYM1 / VYM0)$

(Note 1) : When testing, see the picture sharpness test circuit diagram. First turn ACB mode off (bus control).
 (Note 2) : Ensure the composite signal is always input to pin 38 (SYNC IN).

NOTE		ITEM		(TEST CONDITIONS $V_{CC} = 9V/5V$, $T_a = 25 \pm 3^\circ C$)	
				SW MODE	MEASUREMENT METHOD
P16	Sharpness Peak Frequency	A	B	OPEN	<ol style="list-style-type: none"> ① Set the bus control data to the preset value. ② Set SW54 to A and input a sweep signal to TP54. ③ Set the amplitude of #54 to 20 mV_{p-p}. ④ Set the unicolor to the maximum (111111), set the brightness to the center (1000000), set the RGB cutoff to the center (1000000), turn the Y mute off (0), turn test mode on (0), and set the picture sharpness to the maximum (111111). ⑤ Connect an emitter-follower to TP13 (R OUT) and use a spectrum analyzer to observe TP13 (R OUT). ⑥ Seek the peak point frequency FAP as shown in the diagram.

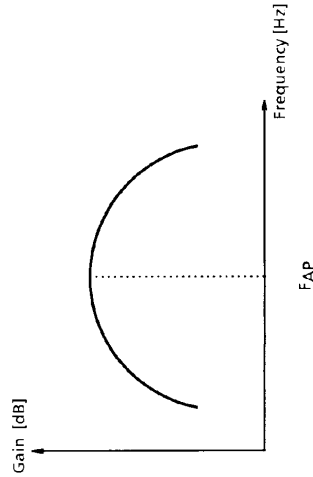

(Note 1) : When testing, see the picture sharpness test circuit diagram. First turn ACB mode off (bus control).
 (Note 2) : Ensure the composite signal is always input to pin 38 (SYNC IN).

(TEST CONDITIONS $V_{CC} = 9V/5V$, $T_a = 25 \pm 3^{\circ}C$)		
NOTE	ITEM	MEASUREMENT METHOD
		SW MODE
P17	Sharpness Control Range	SW54 SW55 SW56
		<p>① Set the bus control data to the preset value.</p> <p>② Set SW54 to A and input a sine wave to TP54A.</p> <p>③ Set the amplitude of #54 to 20 mV_{p-p}.</p> <p>④ Set the unicolor to the maximum (111111), the brightness to the center (1000000), RGB cutoff to the center (1000000), and turn the Y mute off (0).</p> <p>⑤ Set the picture sharpness to the maximum (111111). Connect an emitter-follower to TP13 (R OUT). When the frequencies are 100 kHz and 2.4 MHz, measure the respective V100 and V24 amplitudes.</p> <p>⑥ Next, set the picture sharpness to the minimum (000000). As in ⑤, when the frequencies are 100 kHz and 2.4 MHz, measure the V100 and V24 amplitudes respectively.</p> <p>⑦ Calculate GMAX and GMIN from the following formula. $G_{MAX} \cdot G_{MIN} [dB] = 20 \times \log (V_{24} \div V_{100})$</p>
P18	Sharpness Control Center Characteristics	<p>① Repeat steps ① to ④ of P17.</p> <p>② Set the picture sharpness to the center (100000)</p> <p>③ Connect an emitter-follower to TP13 (R OUT). When the frequencies are 100 kHz and 2.4 MHz, measure the V100 and V24 amplitudes respectively.</p> <p>④ Calculate GCEN from the following formula. $GCEN [dB] = 20 \times \log (V_{24} \div V_{100})$</p>

(Note 1) : When testing, see the picture sharpness test circuit diagram. First turn ACB mode off (bus control).

(Note 2) : Ensure the composite signal is always input to pin 38 (SYNC IN).

NOTE		ITEM		SW MODE		MEASUREMENT METHOD
				SW ₅₄	SW ₅₅	
P19	Between Y IN and R OUT Delay Time	A	B	OPEN	<p>(TEST CONDITIONS $V_{CC} = 9V/5V$, $T_a = 25 \pm 3^{\circ}C$)</p> <ol style="list-style-type: none"> Set the bus control data to the preset value. Set SW₅₄ to A and input a 2T pulse (STD) signal from TG-7 to TP54A. Set the unicolor to the maximum (111111), the brightness to the center (1000000), the RGB cutoff to the center (1000000), turn the Y mute off (0), and set the picture sharpness to the center (100000). Connect an emitter-follower to TP13 (R OUT) to observe TP13 (R OUT). Calculate T_y from the following diagram. 	

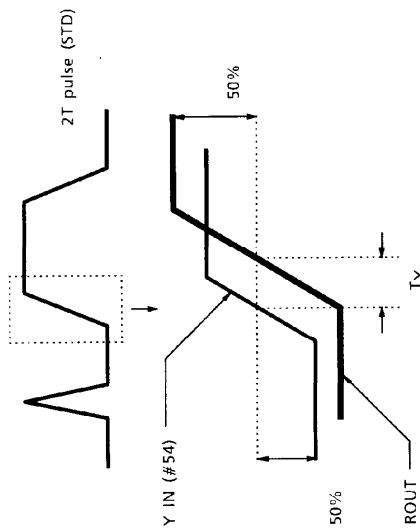

(Note 1) : When testing, see the picture sharpness test circuit diagram. First turn ACB mode off (bus control).
 (Note 2) : Ensure the composite signal is always input to pin 38 (SYNC IN).

		(TEST CONDITIONS $V_{CC} = 9V/5V$, $T_a = 25 \pm 3^\circ C$)		
NOTE	ITEM	SW MODE		MEASUREMENT METHOD
		SW54	SW55 SW56	
P20	VSM Peak Frequency	A	B OPEN	<ol style="list-style-type: none"> ① Set the bus control data to the preset value. ② Set SW54 to A, turn the Y mute off, and input a sweep signal to TP54. ③ Set the #54 amplitude to 100 mV_{p-p}. ④ Observe TP1 (VSMOUT) with a spectrum analyzer and seek the peak point frequency FVSM.
P21	VSM Gain	A	B OPEN	<ol style="list-style-type: none"> ① Set the bus control data to the preset value. ② Set SW54 to A, turn the Y mute off (0), and input the FVSM sine wave (see P20 above) to TP54. ③ Set the amplitude of #54 to 100 mV_{p-p}. ④ When the VSM gain is on (0), measure the TP1 (VSMOUT) amplitude V_{VSM0} (V_{p-p}). ⑤ Next, measure the TP1 (VSMOUT) amplitude V_{VSM1} (V_{p-p}) when the VSM gain is off (1). ⑥ Calculate G_{VSM0} and G_{VSM1} by the following formulas. $G_{VSM0} [dB] = 20 \times \log (V_{VSM0} \div 0.1)$ $G_{VSM1} [dB] = 20 \times \log (V_{VSM1} \div 0.1)$
P22	VSM Muting Threshold Voltage	A	B OPEN	<ol style="list-style-type: none"> ① Repeat steps ① to ③ of P21. ② Connect the external power supply (PS) to #10 and increase the voltage from 0.5 V. Read the PS voltage V_{VM10} when the TP1 (VSMOUT) amplitude disappears, as shown in the following diagram. ③ Set SW6 to open, connect #6 to an external power supply, increase the voltage from 1.5 V. When the TP1 (VSMOUT) amplitude disappears as shown in the following diagram, read the PS voltage V_{VM6}. <div style="text-align: center;"> <p style="text-align: center;">VSMOUT waveform →</p> <p style="text-align: center;">VSMOUT waveform →</p> </div>

(Note 1) : When testing, see the picture sharpness test circuit diagram. First turn ACB mode off (bus control).

(Note 2) : Ensure the composite signal is always input to pin 38 (SYNC IN).

NOTE		ITEM	SW MODE		MEASUREMENT METHOD
			SW54	SW55 SW56	
P23		VSM High Speed Muting Response Time	A	B OPEN	<p>(TEST CONDITIONS $V_{CC} = 9V/5V$, $T_a = 25 \pm 3^{\circ}C$)</p> <ol style="list-style-type: none"> Repeat steps ① to ③ of P21 above. Set SW₆ to open, input a pulse as shown below to #6 (Ys/Ym IN), and measure the response times THM1 and THM2 at that input. Similarly, input the pulse to #10 (OSD Ys IN) and measure the response times THM3 and THM4 at that input.

(Note 1) : When testing, see the picture sharpness test circuit diagram. First turn ACB mode off (bus control).
 (Note 2) : Ensure the composite signal is always input to pin 38 (SYNC IN).

NOTE		ITEM		SW MODE		MEASUREMENT METHOD
		SW54	SW55	SW56		
(TEST CONDITIONS $V_{CC} = 9\text{ V}/5\text{ V}$, $T_a = 25 \pm 3^\circ\text{C}$)						
P24	VSM Phase	A	B	OPEN		<p>① Set the bus control data to the preset value.</p> <p>② Input a signal like that shown in the diagram below to TP54, turn the Y mute off (0), and adjust the amplitude of #54 to 0.7 V_{p-p}.</p> <p>③ Set the unicolor to the maximum (11111), increase the picture sharpness from the minimum to a level where the R OUT waveform is not distorted.</p> <p>④ Measure the phase differences T_{VM24}, T_{VMFP}, and T_{VM2T} between TP1 (VSMOUT) and TP13 (R OUT) when the signal is an FVSM sine wave, a 2T pulse, and a 2.4-MHz signal, as shown in the diagram below. (To make a waveform at TP1, reverse the waveform at TP13 using an oscilloscope.)</p>

(Note 1) : When testing, see the picture sharpness test circuit diagram. First turn ACB mode off (bus control).

(Note 2) : Ensure the composite signal is always input to pin 38 (SYNC IN).

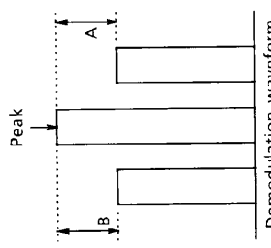
Chroma stage				MEASUREMENT METHOD	
NOTE	ITEM	SW MODE		(#16 V _{CC} = 9 V, #37 V _{CC} = 9 V, #51 V _{CC} = 5 V, Ta = 25 ± 3°C)	
		SW45	SW46		
C1	ACC Characteristics	B	ON	① Input a rainbow signal (signal C-1) to the chroma input pin (TP45). Burst : chroma = 1 : 1 ② When the chroma input amplitude levels are set to 10, 30, 300, and 600 mV _{p-p} , measure the output amplitudes va10, va30, va300, and va600 of the R-Y output pin (TP48). ③ Calculate A = va30 / va600.	
C2	Color Difference Output Level	B	ON	① Input a rainbow signal (signal C-1) to the chroma input pin (TP45). Burst : chroma = 300 mV _{p-p} : 300 mV _{p-p} ② Change the burst phase so that bar 2 of the B-Y output pin (TP47) output waveform is the bottom peak and bar 7 is the top peak. ③ Measure the amplitude (v _B) of the B-Y output pin (TP47). ④ Set the burst phase to 180°.	
C3	Color Difference Output Relative Amplitude	B	ON	⑤ Measure the amplitude (v _R) of the R-Y output pin (TP48). ① Calculate the relative amplitude v _{RB} from the following formula using the values obtained in steps ③ and ⑤ of C02 above. $v_{RB} = v_R / v_B$	
C4	Color Difference Output Demodulation Angle	B	ON	① Input a rainbow signal (C-1) to the chroma input pin (TP45). Burst : chroma = 200 mV _{p-p} : 200 mV _{p-p} ② Calculate the demodulation angles θ _{Bcnt} and θ _{Rcnt} of the B-Y output pin (TP47) and the R-Y output pin (TP48) using the formulas and diagram below. <div style="text-align: center;">  $\theta_{Bcnt} = 0^\circ - \tan^{-1} \left[\frac{1}{\frac{2A}{B} + \sqrt{3}} \right] - 15^\circ$ <p style="text-align: center;">(Bar 6 is the peak at B-Y)</p> $\theta_{Rcnt} = 90^\circ - \tan^{-1} \left[\frac{1}{\frac{2A}{B} + \sqrt{3}} \right] - 15^\circ$ <p style="text-align: center;">(Bar 3 is the peak at R-Y)</p> </div>	
C5	Color Difference Output Relative Phase	B	ON	① Calculate the relative phase θ _{RB} from the following formula using the values obtained in C04 above. $\theta_{RB} = \theta_{Rcnt} - \theta_{Bcnt}$	

(Note 1) : Where the bus data are not specified, set the preset values.

(Note 2) : Ensure the sync signal is always input to TP38 (SYNC IN).

NOTE	ITEM	SW MODE		MEASUREMENT METHOD
		SW45	SW46	
				(#16 V _{CC} = 9 V, #37 V _{CC} = 9 V, #51 V _{CC} = 5 V, T _a = 25 ± 3°C)
C6	Color Difference Output Tint Adjustment Characteristics	B	ON	<p>① Input a rainbow signal (signal C-1) to the chroma input pin (TP45). Burst : chroma = 300 mV_{p-p} : 300 mV_{p-p}</p> <p>② Measure the demodulation angles $\theta_{B'}$ and $\theta_{R'}$ in the outputs with the tint set to the maximum (subaddress (03H), data (FE)). Calculate θ_{Bmax} and θ_{Rmax} by the following formulas. $\theta_{Bmax} = \theta_{B'} - \theta_{Bcnt}$ $\theta_{Rmax} = \theta_{R'} - \theta_{Rcnt}$</p> <p>③ Measure the demodulation angles $\theta_{B''}$ and $\theta_{R''}$ in the outputs with the tint set to the minimum (subaddress (03H), data (00)). Calculate θ_{Bmin} and θ_{Rmin} by the following formulas. $\theta_{Bmin} = \theta_{B''} - \theta_{Bcnt}$ $\theta_{Rmin} = \theta_{R''} - \theta_{Rcnt}$</p>
C7	Supply Voltage Dependence of Color Difference Output	B	ON	<p>① Input a rainbow signal (signal C-1) to the chroma input pin (TP45). Burst : chroma = 300 mV_{p-p} : 300 mV_{p-p}</p> <p>② As in C02, measure the amplitudes ΔVBp and ΔVRp of the B-Y output pin (TP47) and R-Y output pin (TP48) when the 5-V V_{CC} is set to 5 V + 0.3 V. Calculate the amplitude ratios BVp and RVp when the 5-V V_{CC} is set to 5 V. $BVp = \frac{\Delta VBp - vB}{vB} \times 100 \quad RVp = \frac{\Delta VRp - vR}{vR} \times 100$</p> <p>③ Using the same tests as above, calculate BVn and RVn when the 5-V V_{CC} is set to 5V-0.3 V $BVn = \frac{\Delta VBn - vB}{vB} \times 100 \quad RVn = \frac{\Delta VRn - vR}{vR} \times 100$</p>
C8	Identification Sensitivity	B	ON	<p>① Input a rainbow signal (signal C-1) to the chroma input pin (TP45). Burst : chroma = 1 : 1</p> <p>② Gradually reduce the input signal amplitude from 100 mV_{p-p}. When the B-Y output pin (TP47) signal disappears (when the current is DC), measure the input signal amplitude vCB.</p> <p>③ Gradually increase the input signal amplitude from 0 mV_{p-p}. When a demodulation signal appears on the B-Y output pin (TP47), measure the input signal amplitude vBC.</p>
C9	Bus Read Identification	B	ON	<p>① Perform the same tests as above while observing the bus read : When the input signal amplitude is vCB, check that the first bit is set to 0 (bCB). When the input signal amplitude is vBC, check that the first bit is set to 1 (bBC).</p>

(Note 1) : Where the bus data are not specified, set the preset values.

(Note 2) : Ensure the sync signal is always input to TP38 (SYNC IN).

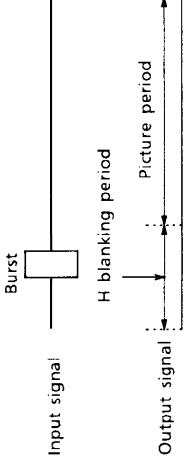
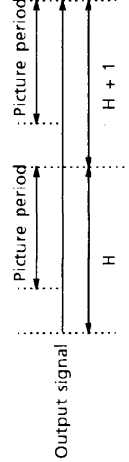
NOTE	ITEM	SW MODE		MEASUREMENT METHOD
		SW45	SW46	
(#16 $V_{CC} = 9V$, #37 $V_{CC} = 9V$, #51 $V_{CC} = 5V$, $T_a = 25 \pm 3^\circ C$)				
C10	Color Difference Output Voltage Difference in 1H Period	B	ON	<p>① Input no more than 300-mV_{p-p} as a burst signal to chroma input pin (TP45).</p> <p>② Measure the DC voltage difference (vBH) between the H blanking period and picture period of the B-Y output pin (TP47).</p> <p>③ Measure the DC voltage difference (vRH) between the H blanking period and picture period of the R-Y output pin (TP48).</p> 
C11	Color Difference Output Voltage Difference Every 1H Period	B	ON	<p>① Input no more than 300-mV_{p-p} as a burst signal to chroma input pin (TP45).</p> <p>② Measure the DC voltage difference (vBG) between the H picture period and H + 1 picture period of the B-Y output pin (TP47).</p> <p>③ Measure the DC voltage difference (vRG) between the H picture period and H + 1 picture period of the R-Y output pin (TP48).</p> 
C12	Color Difference Output DC Voltage	B	ON	<p>① Input no more than 300-mV_{p-p} as a burst signal to chroma input pin (TP45).</p> <p>② Measure the picture period DC voltage V_B of the B-Y output pin (TP47).</p> <p>③ Measure the picture period DC voltage V_R of the R-Y output pin (TP48).</p>
C13	Difference between DC Voltage Axes of Color Difference Output	B	ON	<p>① Use the following formula to calculate the difference (V_{RB}) between the voltage axes from the following formula using the values obtained in C12 above.</p> $V_{RB} = V_R - V_B$
C14	X'tal Free-Run Frequency	A	ON	<p>① No signal input to the chroma input pin (TP45) (set SW45 to A).</p> <p>② Observe the CW output pin (TP50) and measure the output frequency X_f.</p>

(Note 1) : Where the bus data are not specified, set the preset values.

(Note 2) : Ensure the sync signal is always input to TP38 (SYNC IN).

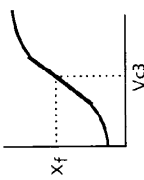
NOTE	ITEM	SW MODE		MEASUREMENT METHOD
		SW45	SW46	
(#16 V _{CC} = 9 V, #37 V _{CC} = 9 V, #51 V _{CC} = 5 V, T _a = 25 ± 3°C)				
C15	APC Frequency Control Sensitivity	A	OFF	<p>① No signal input to the chroma input pin (TP45) (set SW45 to A).</p> <p>② Set SW46 to open and connect an external power supply to the APC filter pin (#46).</p> <p>③ Change the voltage of external power supply to a value regarded as V_{c3}, where the output frequency of the CW output pin (TP50) is 3.579545 MHz (X_f).</p> <p>④ Measure the CW output frequencies X_f (+100) and X_f (-100) for V_{c3} + ΔV_{c3} (±100 mV). Calculate the free-run sensitivity β_f from the following formula.</p> <div style="text-align: center;">  $\beta_f = \frac{X_f(+100) - X_f(-100)}{200}$ </div>
C16	APC Pull-In / Hold Range	B	ON	<p>① Input a 3.579545-MHz sine wave (300 mV_{p-p}) to the chroma input pin (TP45).</p> <p>② Vary the input sine wave frequency in ±10-Hz steps from 3.579545 MHz. When the B-Y output pin (TP47) picture period amplitude changes, measure the difference between 3.579545 MHz and the varied sine wave frequencies : on the plus side, f_{h+}, and on the minus side, f_{h-}(hold).</p> <p>③ Increase and decrease the above measured values by 1 kHz : (f_{h+}) + 1 kHz and (f_{h-}) - 1 kHz. Adjust to approximately 3.579545 MHz in ±10-Hz steps. When the B-Y output pin (TP47) picture period amplitude changes, measure the difference from 3.579545 MHz : on the plus side, f_{p+}, and on the minus side, f_{p-} (pull-in).</p>
C17	Residual Carrier Level	B	ON	<p>① Input a rainbow signal (signal C-1) to the chroma input pin (TP45). Burst : chroma = 300 mV_{p-p} : 300 mV_{p-p}</p> <p>② Measure the color subcarrier leak levels v_{BNo} and v_{RNo} of the B-Y output pin (TP47) and the R-Y output pin (TP48).</p>
C18	Residual Higher Harmonic Level	B	ON	<p>① Input a rainbow signal (signal C-1) to the chroma input pin (TP45). Burst : chroma = 300 mV_{p-p} : 300 mV_{p-p}</p> <p>② Measure the higher harmonic levels v_{BHN} and v_{RHN} of the B-Y output pin (TP47) and the R-Y output pin (TP48).</p>

(Note 1) : Where the bus data are not specified, set the preset values.

(Note 2) : Ensure the sync signal is always input to TP38 (SYNC IN).

NOTE	ITEM	SW MODE		MEASUREMENT METHOD
		SW45	SW46	
(#16 V _{CC} = 9 V, #37 V _{CC} = 9 V, #51 V _{CC} = 5 V, Ta = 25 ± 3°C)				
C19	TOF-BPF Characteristics	B	ON	<ol style="list-style-type: none"> ① Connect the V_{CC} (5 V) via a 750 Ω resistor to the R-Y output pin (TP48). ② Input a 3.579545-MHz sine wave (50 mV_{p-p}) to the chroma input pin (TP45). ③ Set to BPF mode (subaddress (03H), data (80)). ④ Set f₀ of the sine wave to (3.579545 M – 1 M) Hz, measure the output amplitude of TP48, and calculate the gain from the input (GB_L). ⑤ Set f₀ of the sine wave to (3.579545 M + 1 M) Hz, measure the output amplitude of TP48, and calculate the gain from the input (GB_H). ⑥ Set to TOF mode (subaddress (03H), data (81)). ⑦ Set f₀ of the sine wave to (3.579545 M – 1 M) Hz, measure the output amplitude of TP48, and calculate the gain from the input (GT_L). ⑧ Set f₀ of the sine wave to (3.579545 M + 1 M) Hz, measure the output amplitude of TP48, and calculate the gain from the input (GT_H).
C20	CW Output Amplitude	B	ON	<ol style="list-style-type: none"> ① Input a rainbow signal (signal C-1) to the chroma input pin (TP45). Burst : chroma = 300 mV_{p-p} : 300 mV_{p-p} ② Measure the amplitude v_{CW} of the CW output pin.

(Note 1) : Where the bus data are not specified, set the preset value.

(Note 2) : Ensure the sync signal is always input to TP38 (SYNC IN).

Color difference stage

NOTE	ITEM	SW MODE			MEASUREMENT METHOD
		SW6	SW45	SW52 SW53	
(#16 V _{CC} = 9 V, #37 V _{CC} = 9 V, #51 V _{CC} = 5 V, T _a = 25 ± 3°C)					
A1	Color Difference Input Clamp Voltage	C	A	A	<ol style="list-style-type: none"> Connect the color difference input pin to AC-GND. (Set SW52A and SW53A to A.) Measure the voltage V_{RY} of the R-Y input pin (#52) and the voltage V_{BY} of the B-Y input pin (#53).
A2	Color Difference Input / Output Delay Time	C	A	B	<ol style="list-style-type: none"> Set to external color difference input mode (subaddress (05H), data (81)). Now set as follows : Unicolor : maximum (subaddress (00H), data (3F)) Brightness : maximum (subaddress (01H), data (7F)) Color : center (subaddress (02H), data (40)). Set SW52A and SW53A to B. Input signal C-2 to the R-Y input pin (TP52) and the B-Y input pin (TP53). f₀ = 100 kHz, picture period amplitude = 0.2 V_{p-p} Measure the signal delay time (DLRY) from the R-Y input pin (TP52) to the R output (TP13). Measure the signal delay time (DLBY) from the B-Y input pin (TP53) to the B output (TP15).
A3	Unicolor Adjustment Characteristics	C	A	B	<ol style="list-style-type: none"> Set to external color difference input mode (subaddress (05H), data (81)) Now set as follows : Brightness : maximum (subaddress (01H), data (7F)) Color : center (subaddress (02H), data (40)) Relative phase amplitude : standard (subaddress (12H), data (00)). Set SW52A and SW53A to B. Input signal C-2 to the R-Y input pin (TP52) and the B-Y input pin (TP53). f₀ = 100 kHz, picture period amplitude = 0.2 V_{p-p} Set unicolor to the maximum (subaddress (00H), data (3F)). Measure the R_{Umax}, the amplitude of the R output (TP13), and B_{Umax}, the amplitude of B output (TP15). Set unicolor to the minimum (subaddress (00H), data (00)). Measure the R_{Umin}, the amplitude of the R output (TP13), and B_{Umin}, the amplitude of B output (TP15). Calculate the unicolor adjustment characteristics u_R and u_B by the following formulas. $u_R = 20 \text{ Log } \frac{R_{Umin}}{R_{Umax}} \quad u_B = 20 \text{ Log } \frac{B_{Umin}}{B_{Umax}}$

(Note 1) : Where the bus data are not specified, set the preset value.

(Note 2) : Ensure the sync signal is always input to TP38 (SYNC IN).

NOTE	ITEM	SW MODE			MEASUREMENT METHOD
		SW ₆	SW ₄₅	SW ₅₂ SW ₅₃	
A4	Color Adjustment Characteristics	C	A B	B	<p>(#16 V_{CC} = 9V, #37 V_{CC} = 9V, #51 V_{CC} = 5V, T_a = 25 ± 3°C)</p> <p>① Set to external color difference input mode (subaddress (05H), data (81))</p> <p>② Now set as follows :</p> <p>Unicolor : maximum (subaddress (00H), data (3F))</p> <p>Brightness : maximum (subaddress (01H), data (7F))</p> <p>Relative phase amplitude : standard (subaddress (12H), data (00)).</p> <p>③ Set SW_{52A} and SW_{53A} to B. Input signal C-2 to the R-Y input pin (TP52) and the B-Y input pin (TP53).</p> <p>$f_0 = 100$ kHz, picture period amplitude = $0.2 V_{p-p}$</p> <p>④ Set the color to the maximum (subaddress (02H), data (7F)). Measure RC_{max}, the amplitude of the R output (TP13), and BC_{max}, and the amplitude of the B output (TP15).</p> <p>⑤ Set the color to the center (subaddress (02H), data (40)). Measure RC_{cnt}, the amplitude of the R output (TP13), and BC_{cnt}, the amplitude of the B output (TP15).</p> <p>⑥ Set the color to the minimum (subaddress (02H), data (00)). Measure RC_{min}, the amplitude of the R output (TP13), and BC_{min}, the amplitude of the B output (TP15).</p> <p>⑦ Calculate the color adjustment characteristics cR_{max}, cR_{min}, cB_{max}, and cB_{min} by the following formulas.</p> $cR_{max} = 20 \text{ Log } \frac{RC_{MAX}}{RC_{CNT}} \quad cR_{min} = 20 \text{ Log } \frac{RC_{MIN}}{RC_{CNT}}$ $cB_{max} = 20 \text{ Log } \frac{BC_{MAX}}{BC_{CNT}} \quad cB_{min} = 20 \text{ Log } \frac{BC_{MIN}}{BC_{CNT}}$

(Note 1) : Where the bus data are not specified, set the preset value.

(Note 2) : Ensure the sync signal is always input to TP38 (SYNC IN).

NOTE	ITEM	SW MODE			MEASUREMENT METHOD																				
		SW ₆	SW ₄₅	SW ₅₂ SW ₅₃																					
					(#16 V _{CC} = 9 V, #37 V _{CC} = 9 V, #51 V _{CC} = 5 V, T _a = 25 ± 3°C)																				
A5	RGB Output Half-Tone Characteristics	C or B	A B	A	<p>① Input a rainbow signal (signal C-1) to the chroma input pin (TP45). Burst : chroma = 200 mV_{p-p} : 200 mV_{p-p}</p> <p>② Now set as follows :</p> <p>Unicolor : maximum (subaddress (00H), data (3F)) Brightness : maximum (subaddress (01H), data (7F)) Color : center (subaddress (02H), data (40))</p> <p>Relative phase amplitude : standard (subaddress (12H), data (00)).</p> <p>③ Measure the amplitudes v_{Ro}, v_{Go}, and v_{Bo} of the R output pin (TP13), the G output pin (TP14), and the B output pin (TP15).</p> <p>④ Set SW₆ to B and repeat the test in ③ above. Measure the amplitudes v_{RH}, v_{GH}, and v_{BH}.</p> <p>⑤ Calculate the half-tone characteristics v_{RHo}, v_{GHo}, and v_{BHo} by the following formulas.</p> $v_{RHo} = 20 \text{ Log } \frac{v_{RH}}{v_{Ro}} \quad v_{GHo} = 20 \text{ Log } \frac{v_{GH}}{v_{Go}} \quad v_{BHo} = 20 \text{ Log } \frac{v_{BH}}{v_{Bo}}$																				
A6	RGB Output Amplitude	C	A B	A	<p>① Input a rainbow signal (signal C-1) to the chroma input pin (TP45). Burst : chroma = 200 mV_{p-p} : 200 mV_{p-p}</p> <p>② Now set as follows :</p> <p>Unicolor : maximum (subaddress (00H), data (3F)) Brightness : maximum (subaddress (01H), data (7F)) Color : center (subaddress (02H), data (40)).</p> <p>③ Switch the relative phase amplitude (subaddress (12H)) and measure the amplitudes (peak values) of the RGB outputs (TP13, TP14, TP15) according to the table below.</p> <table border="1" style="width: 100%; border-collapse: collapse;"> <tr> <td>Subaddress (12H) data</td> <td>TP13</td> <td>TP14</td> <td>TP15</td> </tr> <tr> <td>STD (00)</td> <td>vRSTD</td> <td>vGSTD</td> <td>vBSTD</td> </tr> <tr> <td>DVD (40)</td> <td>vRDVD</td> <td>vGDVD</td> <td>vBDVD</td> </tr> <tr> <td>TSB (80)</td> <td>vRTSB</td> <td>vGTSB</td> <td>vBTSB</td> </tr> <tr> <td>DTV (C0)</td> <td>vRDTV</td> <td>vGDTV</td> <td>vBDTV</td> </tr> </table>	Subaddress (12H) data	TP13	TP14	TP15	STD (00)	vRSTD	vGSTD	vBSTD	DVD (40)	vRDVD	vGDVD	vBDVD	TSB (80)	vRTSB	vGTSB	vBTSB	DTV (C0)	vRDTV	vGDTV	vBDTV
Subaddress (12H) data	TP13	TP14	TP15																						
STD (00)	vRSTD	vGSTD	vBSTD																						
DVD (40)	vRDVD	vGDVD	vBDVD																						
TSB (80)	vRTSB	vGTSB	vBTSB																						
DTV (C0)	vRDTV	vGDTV	vBDTV																						
A7	RGB Output Relative Amplitude	C	A B	A	<p>① Using the values obtained in A₆ above, calculate the relative amplitudes by the following formulas.</p> $v_{RB***} = \frac{v_{R***}}{v_{B***}} \quad v_{GB} = \frac{v_{G***}}{v_{B***}}$																				

(Note 1) : Where the bus data are not specified, set the preset value.
(Note 2) : Ensure the sync signal is always input to TP38 (SYNC IN).

NOTE	ITEM	SW MODE			MEASUREMENT METHOD																				
		SW6	SW45	SW52 SW53																					
					(#16 V _{CC} = 9 V, #37 V _{CC} = 9 V, #51 V _{CC} = 5 V, Ta = 25 ± 3°C)																				
A8	RGB Output Demodulation Angle	C	B	A	<p>① Input a rainbow signal (signal C-1) to the chroma input pin (TP45). Burst : chroma = 200 mV_{p-p} : 200 mV_{p-p}</p> <p>② Now set as follows :</p> <p>Unicolor : maximum (subaddress (00H), data (3F)) Brightness : maximum (subaddress (01H), data (7F)) Color : center (subaddress (02H), data (40)).</p> <p>Adjust the tint so that the waveform angle of the B-Y output pin (TP47) is 0°.</p> <p>③ Switch the relative phase amplitude (subaddress (12H)) and measure the phase of the RGB outputs (TP13, TP14, TP15) according to the table below.</p> <table border="1" style="margin-left: 20px;"> <thead> <tr> <th>Subaddress (12H) data</th> <th>TP13</th> <th>TP14</th> <th>TP15</th> </tr> </thead> <tbody> <tr> <td>STD (00)</td> <td>θRSTD</td> <td>θGSTD</td> <td>θBSTD</td> </tr> <tr> <td>DVD (40)</td> <td>θRDVD</td> <td>θGDVD</td> <td>θBDVD</td> </tr> <tr> <td>TSB (80)</td> <td>θRTSB</td> <td>θGTSB</td> <td>θBTSB</td> </tr> <tr> <td>DTV (C0)</td> <td>θRDTV</td> <td>θGDTV</td> <td>θBDTV</td> </tr> </tbody> </table> <p>(*) The test method is the same as those for C04 in Chroma stage. (Measure bar 2 of the G axis.)</p>	Subaddress (12H) data	TP13	TP14	TP15	STD (00)	θRSTD	θGSTD	θBSTD	DVD (40)	θRDVD	θGDVD	θBDVD	TSB (80)	θRTSB	θGTSB	θBTSB	DTV (C0)	θRDTV	θGDTV	θBDTV
Subaddress (12H) data	TP13	TP14	TP15																						
STD (00)	θRSTD	θGSTD	θBSTD																						
DVD (40)	θRDVD	θGDVD	θBDVD																						
TSB (80)	θRTSB	θGTSB	θBTSB																						
DTV (C0)	θRDTV	θGDTV	θBDTV																						
A9	RGB Output Relative Phase	C	B	A	<p>① Using the values obtained in A8 above, calculate the relative amplitudes by the following formulas.</p> $\theta_{RB^{***}} = \theta_R^{***} - \theta_B^{***} \quad \theta_{GB^{***}} = \theta_G^{***} - \theta_B^{***}$																				

(Note 1) : Where the bus data are not specified, set the preset value.

(Note 2) : Ensure the sync signal is always input to TP38 (SYNC IN).

NOTE	ITEM	SW MODE			MEASUREMENT METHOD
		SW6	SW45	SW52 SW53	
A11	Color Difference EXT → INT Crosstalk	C	A	B	<p>(#16 V_{CC} = 9 V, #37 V_{CC} = 9 V, #51 V_{CC} = 5 V, T_a = 25 ± 3°C)</p> <p>① No signal input to the chroma input pin (TP45) (set SW45 to A).</p> <p>② Now set as follows :</p> <p>Unicolor : maximum (subaddress 00H), data (3F)</p> <p>Brightness : maximum (subaddress 01H), data (7F)</p> <p>Relative phase amplitude : standard (subaddress 12H), data (00).</p> <p>③ Set SW52A and SW53A to B. Input signal C-2 to the R-Y input pin (TP52) and the B-Y input pin (TP53).</p> <p>f₀ = 4 MHz, picture period amplitude = 0.2 V_{p-p}</p> <p>④ Set to external color difference input mode (subaddress 05H), data (81).</p> <p>⑤ Adjust the color data so that the amplitude of the R output pin (TP13) is 2 V_{p-p}.</p> <p>⑥ Set to internal color difference input mode (subaddress 05H), data (80).</p> <p>⑦ Measure the amplitude VXER of the R output pin (TP13) and calculate the amount of crosstalk.</p> <p style="text-align: center;">$XEIR = 20 \text{ Log } \frac{VXER}{2}$</p> <p>⑧ Repeat steps ④ to ⑦ above for the G and B axes and calculate the amount of crosstalk on those axes.</p> <p style="text-align: center;">$XEIG = 20 \text{ Log } \frac{VXEG}{2}$ $XEIB = 20 \text{ Log } \frac{VXEB}{2}$</p>

(Note 1) : WWhere the bus data are not specified, set the preset value.
 (Note 2) : WEnsure the sync signal is always input to TP38 (SYNC IN).

NOTE	ITEM	SW MODE			MEASUREMENT METHOD
		SW6	SW45	SW52	
A12	Color Difference INT→EXT Crosstalk	C	B	A	A

(#16 V_{CC} = 9 V, #37 V_{CC} = 9 V, #51 V_{CC} = 5 V, T_a = 25 ± 3°C)

- ① Input a rainbow signal (signal C-1) to the chroma input pin (TP45).
Burst : chroma = 200 mV_{p-p} : 200 mV_{p-p}
- ② Now set as follows :
Unicolor : maximum (subaddress (00H), data (3F))
Brightness : maximum (subaddress (01H), data (7F))
Relative phase amplitude : standard (subaddress (12H), data (00)).
- ③ Set SW52A and SW53A to A.
- ④ Set to internal color difference input mode (subaddress (05H), data (80)).
- ⑤ Adjust the color data so that the amplitude of the R output pin (TP13) is 2 V_{p-p}.
- ⑥ Set to external color difference input mode (subaddress (05H), data (81)).
- ⑦ Measure the amplitude V_{XIR} of the R output pin (TP13) and calculate the amount of crosstalk.
$$XIER = 20 \text{ Log } \frac{V_{XIR}}{2}$$
- ⑧ Repeat steps ④ to ⑦ above for the G and B axes and calculate the amount of crosstalk on those axes.
$$XIEG = 20 \text{ Log } \frac{V_{XIG}}{2} \quad XIEB = 20 \text{ Log } \frac{V_{XIB}}{2}$$

(Note 1) : Where the bus data are not specified, set the preset value.
(Note 2) : Ensure the sync signal is always input to TP38 (SYNC IN).

NOTE	ITEM	SW MODE			MEASUREMENT METHOD
		SW ₆	SW ₄₅	SW ₅₂ SW ₅₃	
					<p>(#16 V_{CC} = 9 V, #37 V_{CC} = 9 V, #51 V_{CC} = 5 V, Ta = 25 ± 3°C)</p> <p>① Set to external color difference input mode (subaddress (05H), data (81)).</p> <p>② Now set as follows :</p> <ul style="list-style-type: none"> Unicolor : maximum (subaddress (00H), data (3F)) Brightness : maximum (subaddress (01H), data (7F)) Relative phase amplitude : standard (subaddress (12H), data (00)) Y mute : on (set D7 of subaddress (02H) to 1). <p>③ Set SW_{52a} to a, set SW_{53a} to b, and input the signal shown in Fig.① below to the B-Y input pin (TP53).</p> <p>④ Set the color to the minimum and measure the picture period DC voltage v_{Bγ0} of the B output pin (TP15).</p> <p>⑤ Increase the color from the minimum. When the picture period DC voltage of the R output pin (TP13) changes, measure the picture period DC voltage v_{Bγ1} of the B output pin (TP15).</p> <p>⑥ Using the values obtained above, calculate the color γ start point C_{γsp} by the following formula.</p> $C_{\gamma sp} = v_{B\gamma 1} - v_{B\gamma 0}$
A13	Color γ Characteristics	C	B	A	

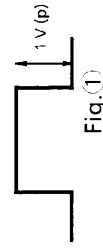

(Note 1) : Where the bus data are not specified, set the preset value.
 (Note 2) : Ensure the sync signal is always input to TP38 (SYNC IN).

Y stage

NOTE	ITEM	MEASUREMENT METHOD	
		SW MODE	
		SW45	(#16 V _{CC} = 9 V, #37 V _{CC} = 9 V, #51 V _{CC} = 5 V, T _a = 25 ± 3°C)
Y1	Sync Input~DL Output AC Gain	A	<p>① Input signal C-2 to the Sync Input pin (TP38). f₀ = 100 kHz, picture period amplitude = 0.2 V_{p-p}</p> <p>② Turn DL mode off (subaddress (12), data (80)) and measure the picture period amplitude v_{43off} of the DL output (TP43). Calculate the gain from the input (GYoff) by the formula shown below.</p> <p>③ Turn DL mode on (subaddress (12), data (A0)) and measure the picture period amplitude v_{43on} of the DL output (TP43). Calculate the gain from the input (GYon) by the formula shown below.</p> $GYoff = 20 \text{ Log } \frac{v_{43off}}{0.2} \quad GYon = 20 \text{ Log } \frac{v_{43on}}{0.2}$
Y2	Sync Input~DL Output Frequency Gain	A	<p>① Input signal C-2 to the Sync Input pin (TP38). f₀ = 8 MHz, picture period amplitude = 0.2 V_{p-p}</p> <p>② Turn DL mode off (subaddress (12), data (80)) and measure the picture period amplitude v_{438Moff} of the DL output (TP43). Calculate the gain from the input (GfYoff) by the formula shown below.</p> <p>③ Turn DL mode on (subaddress (12), data (A0)) and measure the picture period amplitude v_{438Mon} of the DL output (TP43). Calculate the gain from the input (GfYon) by the formula shown below.</p> $GfYoff = 20 \text{ Log } \frac{v_{438Moff}}{v_{43off}} \quad GfYon = 20 \text{ Log } \frac{v_{438Mon}}{v_{43on}}$
Y3	Sync Input~DL Output Dynamic Range	A	<p>① Input signal C-3 to the Sync Input pin (TP38).</p> <p>② When the amplitude A of signal C-3 is increased from 0, observe the change in the picture period amplitude of the DL output (TP43). With DL mode turned on and off, when the output amplitude stops changing in a linear direction, measure the input signal amplitude A.</p>
Y4	Sync Input~DL Output Transfer Characteristics	A	<p>① Input signal C-2 to the Sync Input pin (TP38). f₀ = 100 kHz, picture period amplitude = 0.2 V_{p-p}</p> <p>② Turn DL mode on (subaddress (12H), data (20)) and measure the amount of delay TYLD from the Sync Input (#38) to the DL output (TP43).</p>

(Note 1) : Where the bus data are not specified, set the preset value.

(Note 2) : Ensure the sync signal is always input to TP38 (SYNC IN).

Text stage

NOTE	ITEM	(TEST CONDITIONS VCC = 5V and 9V, Ta = 25 ± 3°C)										MEASUREMENT METHOD
		SW MODE & SUB ADDRESS & DATA										
		S03	S04	S05	S06	S07	S08	S09	S10	S14	S54	
T1	AC Gain	A	A	A	OFF	A	A	A	OFF			<ol style="list-style-type: none"> Input signal 1 (f = 100 kHz, picture period amplitude = 0.2 V_{p-p}) to pin 54. Measure the picture period amplitudes of pins 13, 14, and 15. (v13, v14, v15) GR = v13/0.2 GG = v14/0.2 GB = v15/0.2
T2	Frequency Characteristics	A	A	A	OFF	A	A	A	OFF			<ol style="list-style-type: none"> Input signal 1 (f = 8 MHz, picture period amplitude = 0.2 V_{p-p}) to pin 54. Measure the picture period amplitudes of pins 13, 14, and 15. (v13 8 MHz, v14 8 MHz, and v15 8 MHz). Using the values obtained in T01 above, calculate the frequency characteristics from the following formulas. GfR = 20 × fog (v13 8 MHz / v13) GfG = 20 × fog (v14 8 MHz / v14) GfB = 20 × fog (v15 8 MHz / v15)
T3	Unicolor Adjustment Characteristics	A	A	A	OFF	A	A	A	OFF			<ol style="list-style-type: none"> Input signal 1 (f = 100 kHz, picture period amplitude = 0.2 V_{p-p}) to pin 54. When the subaddress (00, unicolor) data are changed to the maximum (3F), the center (20), and the minimum (00), measure the picture period amplitude of pin 13. (V_U^{MAX}, V_U^{CNT}, V_U^{MIN}) Calculate the maximum, minimum amplitude ratio for unicolor in decibels. (ΔV_U)
T4	Brightness Adjustment Characteristics	A	A	A	OFF	A	A	A	OFF			<ol style="list-style-type: none"> Input signal 2 to pin 54 and adjust the picture period amplitude input of pin 13 to 1 V_{p-p}. When the subaddress (01, brightness) data are changed to the maximum (FF), the center (C0), and the minimum (80), measure the picture period DC voltage of pin 13. (V_{Br}^{MAX}, V_{Br}^{CNT}, V_{Br}^{MIN})
T5	Brightness Control Sensitivity	A	A	A	OFF	A	A	A	OFF			<ol style="list-style-type: none"> Using the values obtained in T04 above, calculate the brightness sensitivity from the following formula. Gbr = (V_{Br}^{MAX} - V_{Br}^{MIN}) / 128

TA1310AN-59

NOTE	ITEM	(TEST CONDITIONS $V_{CC} = 5V$ and $9V$, $T_a = 25 \pm 3^\circ C$)										MEASUREMENT METHOD	
		SW MODE & SUB ADDRESS & DATA											
		S03	S04	S05	S06	S07	S08	S09	S10	S14	S54		
T6	White Peak Slice Level	A	A	A	OFF	A	A	A	A	OFF	A	A	<ol style="list-style-type: none"> Change the bus data and set the sub-contrast to the maximum. Input signal 2 to pin 54 and gradually increase the amplitude. When pin 13's picture period is clipped, measure the picture period amplitude of pin 13.
T7	Black Peak Slice Level	A	A	A	OFF	A	A	A	A	OFF	A	C	<ol style="list-style-type: none"> Apply an external power supply to pin 54 and gradually decrease the voltage from 3.7 V. When their picture periods are clipped, measure the picture period amplitudes of pins 13, 14, and 15.
T8	DC Restoration	A	A	A	OFF	A	A	A	A	OFF	A	A	<ol style="list-style-type: none"> Input the TG7 stair-step signal to pin 54. Adjust the unicolor data so that the pin 13 stair-step output signal is $1.25 V_{p-p}$. When the stair-step signal APL is changed from 10% to 90%, measure the voltage change at point A in the diagram below. Repeat steps ① to ③ above on pins 14 and 15.

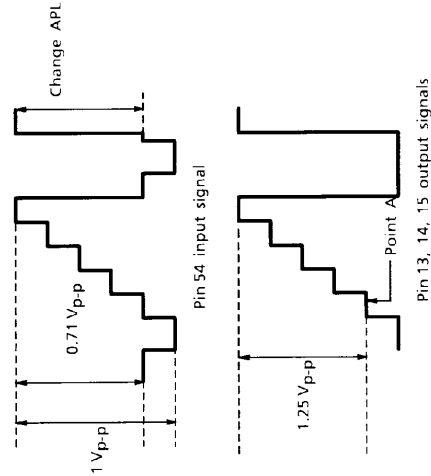

NOTE	ITEM	(TEST CONDITIONS V _{CC} = 5V and 9V, T _a = 25 ± 3°C)											MEASUREMENT METHOD
		SW MODE & SUB ADDRESS & DATA											
		S03	S04	S05	S06	S07	S08	S09	S10	S11	S54		
T ₉	RGB Output S/N	A	A	A	OFF	A	A	A	OFF	A	OFF	C	<ol style="list-style-type: none"> Measure the picture period noise levels of pins 13, 14, and 15 with an oscilloscope. Calculate the S/N for each pin. $N_{13} = -20 \times \text{Log}(2.5 / (0.2 \times n_{13}))$ $N_{14} = -20 \times \text{Log}(2.5 / (0.2 \times n_{14}))$ $N_{15} = -20 \times \text{Log}(2.5 / (0.2 \times n_{15}))$
T ₁₀	RGB Output Emitter-Follower Drive Current	A	A	A	OFF	A	A	A	OFF	A	OFF	C	<ol style="list-style-type: none"> Connect a 3.5-V external power supply to pin 13 via a 100-Ω resistor (#13) and measure the sink current on pin 13. Perform the same test on pins 14 and 15. (#14, #15)
T ₁₁	RGB Output Temperature Coefficient	A	A	A	OFF	A	A	A	OFF	A	OFF	C	<ol style="list-style-type: none"> When the temperature changes through the range -20°C to +65°C, measure the changes in the picture period amplitudes of pins 13, 14, and 15. Calculate the voltage changes per degree of temperature. (Δt_{13}, Δt_{14}, Δt_{15})
T ₁₂	Half-Tone Characteristics	A	A	A	OFF	A	A	A	OFF	A	OFF	A	<ol style="list-style-type: none"> Input signal 1 (f = 100 kHz, picture period amplitude = 0.2 V_{p-p}) to pin 54. Measure the picture period amplitude of pin 13. (V_{13A}) Apply 1.5V DC to pin 6. Measure the picture period amplitude of pin 13. (V_{13B}) GHT = V_{13B}/V_{13A}
T ₁₃	Half-Tone ON Voltage	A	A	A	OFF	A	A	A	OFF	A	OFF	A	<ol style="list-style-type: none"> Input signal 1 (f = 100 kHz, picture period amplitude = 0.2 V_{p-p} to pin 54. Connect an external power supply to pin 6 and gradually increase the voltage from 0 V. When the picture period amplitude of pin 13 changes, measure the pin 3 voltage. (V_{HT})
T ₁₄	V-BLK Pulse Output Level	A	A	A	OFF	A	A	A	OFF	A	OFF	C	<ol style="list-style-type: none"> Measure the voltages of pins 13, 14, and 15 during the vertical blanking period. (V_{VR}, V_{VG}, V_{VB})
T ₁₅	H-BLK Pulse Output Level	A	A	A	OFF	A	A	A	OFF	A	OFF	C	<ol style="list-style-type: none"> Measure the voltages of pins 13, 14, and 15 during the horizontal blanking period. (V_{HR}, V_{HG}, V_{HB})

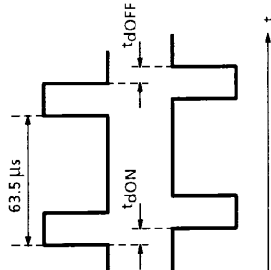
NOTE		(TEST CONDITIONS $V_{CC} = 5V$ and $9V$, $T_a = 25 \pm 3^\circ C$)										MEASUREMENT METHOD
		SW MODE & SUB ADDRESS & DATA										
ITEM		S03	S04	S05	S06	S07	S08	S09	S10	S14	S54	
T16	Blanking Pulse Delay Time	A	A	A	OFF	A	A	A	OFF	A	C	<p>① Measure t_{dON} and t_{dOFF} using the signal input to pin 34 (FBN-IN) (A below) and the signals output from pins 13, 14, and 15 (B below).</p> <p>(A) Signal input to pin 34</p>  <p>(B) Signals output from pins 13, 14, and 15</p>
T17	Sub-Contrast Control Range	A	A	A	OFF	A	A	A	OFF	A	A	<p>① Input signal 1 ($f = 100\text{ kHz}$, picture period amplitude = $0.2 V_{p-p}$) to pin 54.</p> <p>② When the subaddress (0F, sub-contrast) data are changed to the maximum (8F), the center (88), and the minimum (80), measure the picture period amplitude of pin 13.</p> <p>③ Calculate the maximum and minimum amplitude ratios in relation to the sub-contrast center in decibels. ($\Delta V_{SU+}, \Delta V_{SU-}$)</p>
T18	RGB Output Voltage	A	A	A	OFF	A	A	A	OFF	A	C	<p>① Measure the picture period amplitudes of pins 13, 14, and 15.</p>
T19	Cut-Off Voltage Control Range	A	A	A	OFF	A	A	A	OFF	A	C	<p>① When the R cutoff (subaddress (08)) data are changed to the maximum (FF), the center (80), and the minimum (00), measure the picture period amplitude of pin 13 and calculate the change in maximum and minimum from the center. (CUT+, CUT-)</p> <p>② Make the following changes in steps (1) and (2) above and measure : Change the subaddress (09) data and measure pin 14. Change the subaddress (0A) data and measure pin 15.</p>

TA1310AN-62

(TEST CONDITIONS V _{CC} = 5V and 9V, T _a = 25 ± 3°C)											
NOTE	ITEM	SW MODE & SUB ADDRESS & DATA								MEASUREMENT METHOD	
		S03	S04	S05	S06	S07	S08	S09	S10		S54
T20	Drive Adjustment Range	A	A	A	OFF	A	A	A	OFF	A	① Input signal 1 (f = 100 kHz, picture period amplitude = 0.2 V _{p-p}) to pin 54. ② When the G drive subaddress (06) data are changed to the maximum (FE), the center (80), and the minimum (00), measure the picture period amplitude of pin 14. ③ Calculate the maximum and minimum amplitude ratios in relation to the drive center in decibels. (DRG+, DRG-) ④ Repeat steps ① to ③ above with the subaddress (07) data and pin 15 instead of 14. (DRB+, DRB-)
T21	#11 Input Impedance	A	A	A	OFF	A	A	A	OFF	C	① Adjust the external power supply voltage until the ammeter reads 0. ② When the pin 11 voltage is increased by 0.2 V, measure the ammeter current. (i) $Z_{in11} (\Omega) = 0.2 (V) \div i (A)$
T22	ACL Characteristics	A	A	A	OFF	A	A	A	OFF	A	① Input signal 1 (f = 100 kHz, picture period amplitude = 0.2 V _{p-p}) to pin 54. ② Measure the picture period amplitude of pin 13 (V _{ACL1}). ③ Apply -0.5 V DC to pin 11 from an external power supply and measure the picture period amplitude of pin 13. (V _{ACL2}) ④ Apply -1 V DC to pin 11 from an external power supply and measure the picture period amplitude of pin 13. (V _{ACL3}) ⑤ $ACL1 = -20 \times \log (V_{ACL2} / V_{ACL1})$ $ACL2 = -20 \times \log (V_{ACL3} / V_{ACL1})$

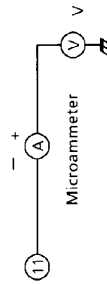

NOTE		(TEST CONDITIONS $V_{CC} = 5V$ and $9V$, $T_a = 25 \pm 3^\circ C$)											MEASUREMENT METHOD
		SW MODE & SUB ADDRESS & DATA											
		S03	S04	S05	S06	S07	S08	S09	S10	S54			
T23	ABL Point	A	A	A	OFF	A	A	A	OFF	A	C	<ol style="list-style-type: none"> ① Measure the DC voltage of pin 11 (VABL1) ② Set the subaddress (04) data to (83). ③ Set the subaddress (00) data to (3F). Apply external voltage to pin 11, decrease the pin voltage from 6.5 V. When the voltage of pin 13 starts to change, measure the voltage of pin 11. (VABL2) ④ Change the subaddress (00) data to (7F), (BF), and (FF), and repeat step ③ for each of these data. (VABL3, VABL4, VABL5) ⑤ ABLP1 = VABL2 - VABL1 ABLP2 = VABL3 - VABL1 ABLP3 = VABL4 - VABL1 ABLP4 = VABL5 - VABL1 	
T24	ABL Gain	A	A	A	OFF	A	A	A	OFF	A	C	<ol style="list-style-type: none"> ① Apply 6.5 V from an external power supply to pin 11. ② Set the subaddress (00) data to (3F). ③ Set the brightness to the maximum. ④ Measure the voltage of pin 13 (VABL6) ⑤ Apply 5 V from the external power supply to pin 11. ⑥ Change the subaddress (04) data to (80), (81), (82), and (83), and repeat step 4 for each of these data. (VABL7, VABL8, VABL9, VABL10) ⑦ ABLG1 = VABL7 - VABL6 ABLG2 = VABL8 - VABL6 ABLG3 = VABL9 - VABL6 ABLG4 = VABL10 - VABL6 	
T25	BLK Off Mode	A	A	A	OFF	A	A	A	OFF	A	C	<ol style="list-style-type: none"> ① Set the subaddress (01) data to (40) and check that the blanking of pins 13, 14, and 15 is turned off. 	

NOTE		(TEST CONDITIONS V _{CC} = 5V and 9V, T _a = 25 ± 3°C)											MEASUREMENT METHOD	
		SW MODE & SUB ADDRESS & DATA												
		S03	S04	S05	S06	S07	S08	S09	S10	S14	S15	S54		
T26	Analog RGB Gain	B	B	B	ON	A	A	A	A	A	A	OFF	C	<p>① Input signal 1 (f = 100 kHz, picture period amplitude = 0.2 V_{p-p}) to pin 3.</p> <p>② Measure the picture period amplitude of pin 13 (v13R).</p> <p>③ As in steps ① and ② above, input to pin 4 and measure pin 14 (v14G), then input to pin 5 and measure pin 15 (v15B).</p> <p>④ GTXR = v13R / 0.2 GTXG = v14G / 0.2 GTXB = v15B / 0.2</p>
T27	Analog RGB Frequency Characteristics	B	B	B	ON	A	A	A	A	A	A	OFF	C	<p>① Input signal 1 (f = 8 MHz, picture period amplitude = 0.2 V_{p-p}) to pin 3.</p> <p>② Measure the picture period amplitude of pin 13. (v13R 8 MHz)</p> <p>③ As in steps ① and ② above, input to pin 4 and measure pin 14, then input to pin 5 and measure pin 15. (v14G 8 MHz, v15B 8 MHz)</p> <p>④ Calculate the frequency characteristics from the above results and the results obtained in T26. GfXR = 20 × log (v13R 8 MHz / v13R) GfXG = 20 × log (v14G 8 MHz / v14G) GfXB = 20 × log (v15B 8 MHz / v15B)</p>
T28	Analog RGB Input Range	B	B	B	ON	A	A	A	A	A	A	OFF	C	<p>① Set the subaddress (00 : unicolor) data to min (00).</p> <p>② Input signal 2 to pin 3 and gradually increase picture amplitude A.</p> <p>③ When the voltage during the picture period of pin 13 stops changing, measure picture amplitude A (DR13).</p> <p>④ Repeat steps (2) and (3) above under the following conditions : Input to pin 4, measure the voltage during the picture period of pin 14 (DR14). Input to pin 5, measure the voltage during the picture period of pin 15 (DR15).</p>

		(TEST CONDITIONS $V_{CC} = 5V$ and $9V$, $T_a = 25 \pm 3^\circ C$)										MEASUREMENT METHOD
NOTE	ITEM	SW MODE & SUB ADDRESS & DATA										
		S03	S04	S05	S06	S07	S08	S09	S10	S14	S54	
T29	Analog RGB White Peak Slice Level	B	B	B	ON	A	A	A	A	OFF	C	<ol style="list-style-type: none"> ① Input signal 2 to pin 3. Gradually increase the picture period amplitude A. ② When pin 13 is clipped, measure the picture period amplitude of pin 13. ③ As in steps ① and ② above, input to pin 4 and measure pin 14, then input to pin 5 and measure pin 15.
T30	Analog RGB Black Peak Limiter Level	A	A	A	ON	A	A	A	A	OFF	C	<ol style="list-style-type: none"> ① Apply an external power supply to pin 3. Gradually decrease the voltage from 5V DC. When pin 13 is clipped, measure the voltage of pin 13. ② As in step ① above, apply to pin 4 and measure pin 14, then apply to pin 5 and measure pin 15.
T31	Analog RGB Contrast Adjustment Characteristics	B	B	B	ON	A	A	A	A	OFF	C	<ol style="list-style-type: none"> ① Input signal 1 ($f = 100\text{ kHz}$, picture period amplitude $= 0.2 V_{p-p}$) to pin 3. ② When the subaddress (00, unicolor) data are changed to the maximum (3F), the center (20), and the minimum (00), measure the picture period amplitude of pin 13. ③ Calculate the maximum and minimum amplitude (vuTXR1, vuTXR2, vuTXR3) ④ As in steps ①, ② and ③ above, input signal 1 to pin 4 and measure pin 14, then input signal 1 to pin 5 and measure pin 15.
T32	Analog RGB Brightness Adjustment Characteristics	B	B	B	ON	A	A	A	A	OFF	C	<ol style="list-style-type: none"> ① Input signal 2 to pins 3, 4, and 5. ② Adjust the signal 2 amplitude A so that the picture period amplitude of pin 13 is $0.5 V_{p-p}$. ③ When the subaddress (05, RGB brightness) data are changed to the maximum (F8), the center (88), and the minimum (08), measure the picture period amplitudes of pins 13, 14, and 15. (vbrTX1, vbrTX2, vbrTX3)

NOTE	ITEM	(TEST CONDITIONS $V_{CC} = 5V$ and $9V$, $T_a = 25 \pm 3^\circ C$)										MEASUREMENT METHOD
		SW MODE & SUB ADDRESS & DATA										
		S03	S04	S05	S06	S07	S08	S09	S10	S54		
T33	Analog RGB Mode On Voltage	B	A	A	OFF	A	A	A	A	OFF	C	<ol style="list-style-type: none"> ① Input signal 1 ($f = 100\text{ kHz}$, picture period amplitude $= 0.2 V_{p-p}$) to pin 3. ② Apply an external power supply to pin 6. Gradually increase the voltage from 0 V. ③ When signal 1 is output to pin 13, measure the voltage of pin 6.
T34	Analog RGB Mode Transfer Characteristics	A	A	A	OFF	A	A	A	A	OFF	C	<ol style="list-style-type: none"> ① Set the subaddress (05, RGB brightness) data to the maximum (F8). ② Input signal 3 (signal amplitude $4.5 V_{p-p}$) to pin 6. ③ Measure the switching transfer characteristics of pins 13, 14, and 15 according to diagram T-2. ④ Using the data obtained from the above measurements, calculate the maximum axis difference between the rising and falling edges of transfer delay time.
T35	Crosstalk from Video to Analog RGB	A	A	A	OFF or ON	A	A	A	A	OFF	A	<ol style="list-style-type: none"> ① Input signal 1 ($f = 4\text{ MHz}$, picture period amplitude $= 0.5 V_{p-p}$) to pin 54. ② Adjust the input amplitude so that the picture period amplitude of pin 13 is $2 V_{p-p}$. ③ Turn SW₆ on. ④ Measure the picture period amplitude (V_{p-p}) of pin 13. (V13A) ⑤ Calculate by the following formula the amount of crosstalk from the video to the analog RGB. $V_v \rightarrow AR = -20 \times \log (V_{13A} / 2)$ ⑥ Repeat steps ④ and ⑤ above on pins 14 and 15.

NOTE	ITEM	(TEST CONDITIONS $V_{CC} = 5V$ and $9V$, $T_a = 25 \pm 3^\circ C$)										MEASUREMENT METHOD
		SW MODE & SUB ADDRESS & DATA										
		S03	S04	S05	S06	S07	S08	S09	S10	S14	S54	
T36	Crosstalk from Analog RGB to Video	B	B	B	ON or OFF	A	A	A	OFF	C		<ol style="list-style-type: none"> Turn SW6 on. Input signal 1 ($f = 4MHz$, picture period amplitude = $0.5 V_{p-p}$) to pin 3. Adjust the input amplitude so that the picture period amplitude of pin 13 is $2 V_{p-p}$. Turn SW6 off. Measure the picture period amplitude (V_{p-p}) of pin 13. (v_{13B}) Calculate by the following formula the amount of crosstalk from the analog RGB to the video. $VA \rightarrow AR = -20 \times \log(v_{13B}/2)$ As in steps ② to ⑥ above, input to pin 4 and measure pin 14, then input to pin 5 and measure pin 15.
T37	Analog OSD Gain	A	A	A	OFF	B	B	B	ON	C		<ol style="list-style-type: none"> Input signal 1 ($f = 100 kHz$, picture period amplitude = $0.2 V_{p-p}$) to pin 7. Measure the picture period amplitude of pin 13. (v_{13R}) As in steps ① and ② above, input to pin 8 and measure pin 14, then input to pin 9 and measure pin 15. (v_{14G}, v_{15B}) $GOSDR = v_{13R}/0.2$ $GOSDG = v_{14G}/0.2$ $GOSDB = v_{15B}/0.2$
T38	Analog OSD Frequency Characteristics	A	A	A	OFF	B	B	B	ON	C		<ol style="list-style-type: none"> Input signal 1 ($f = 8 MHz$, picture period amplitude = $0.2 V_{p-p}$) to pin 7. Measure the picture period amplitude of pin 13. (v_{13R} 8MHz) As in steps ① and ② above, input to pin 8 and measure pin 14, then input to pin 9 and pin 15. (v_{14G} 8MHz, v_{15B} 8MHz) Calculate the frequency characteristics from the above results and the results in T37. $GfOSDR = 20 \times \log(v_{13R} \text{ 8MHz} / v_{13R})$ $GfOSDG = 20 \times \log(v_{14G} \text{ 8MHz} / v_{14G})$ $GfOSDB = 20 \times \log(v_{15B} \text{ 8MHz} / v_{15B})$

NOTE	ITEM	(TEST CONDITIONS $V_{CC} = 5V$ and $9V$, $T_a = 25 \pm 3^\circ C$)										MEASUREMENT METHOD	
		SW MODE & SUB ADDRESS & DATA											
		S03	S04	S05	S06	S07	S08	S09	S10	S11	S54		
T39	Analog OSD Output Level	A	A	A	OFF	A	A	A	OFF	A	OFF	C	<ol style="list-style-type: none"> When 0V (DC) is input from an external power supply to pin 7, when 7.5V is input to pin 7, and when no external voltage is applied to pin 7, measure the picture period amplitude of pin 13. (V OSD1R, V OSD2R, V OSD3R) As in step ① above, input to pin 8 and measure pin 14, then input to pin 9 and measure pin 15. (V OSD1G, V OSD2G, V OSD3G) (V OSD1B, V OSD2B, V OSD3B)
T40	Analog OSD Mode On Voltage	A	A	A	OFF	B	A	A	OFF	A	OFF	C	<ol style="list-style-type: none"> Input signal 1 ($f = 100\text{ kHz}$, picture period amplitude = $0.2 V_{p-p}$) to pin 7. Apply an external power supply to pin 10. Gradually increase the voltage from 0 V. When signal 1 is output to pin 13, measure the pin 10 voltage.
T41	Analog OSD Mode Transfer Characteristics	A	A	A	OFF	A	A	A	OFF	A	OFF	C	<ol style="list-style-type: none"> Apply 2.5V from an external power supply to pins 7, 8, and 9. Input signal 4 (signal amplitude = $4.5 V_{p-p}$) to pin 10. Measure the switching transfer characteristics of pins 13, 14, and 15 according to diagram T-2. Using the data obtained from the above measurements, calculate the maximum axis difference between the rising and falling edge of the transfer delay time.
T42	RGB Output Self-Diagnosis	A	A	A	OFF	A	A	A	OFF	A	OFF	A	<ol style="list-style-type: none"> Set the bus control data to read mode and reset. Set to read mode again. Check that the read mode parameter (RGB-OUT) is 0 (error). Measure the voltage of pin 54 and apply that voltage +0.7 V to pin 53 using an external power supply. Set to read mode again. Check that the read mode parameter (RGB-OUT) is 1 (OK).

NOTE		(TEST CONDITIONS $V_{CC} = 5V$ and $9V$, $T_a = 25 \pm 3^\circ C$)										MEASUREMENT METHOD
		SW MODE & SUB ADDRESS & DATA										
ITEM		S03	S04	S05	S06	S07	S08	S09	S10	S14		
T43	ACB Input Pulse Phase, Amplitude	A	A	A	OFF	A	A	A	OFF	A	A or C	<p>① Input signal 1 ($f = 100$ kHz, picture amplitude $0.2 V_{p-p}$) to pin 53 and adjust drive data so that the picture period amplitude of pins 14 and 15 equals that of pin 13.</p> <p>② Set SW54 to C.</p> <p>③ Measure the voltages on pins 17, 18, and 19 and apply the measured voltages to the pins from an external power supply.</p> <p>④ Set the subaddress (11) data to (50).</p> <p>⑤ According to the voltage on pins 13, 14, and 15 in Figure 1 below, determine the phase of ACB input pulse.</p> <p>Note : The phase starts after the V-BLK period. The picture period after the falling edge of FBP input is 1 H ; then, every time H-BLK ends, the period is 2 H, 3 H, and so on.</p> <p>⑥ According to pins 13, 14, and 15 the voltage on, determine the ACB input pulse amplitude (amplitude from the BLK level at RGB-BLK OFF).</p>

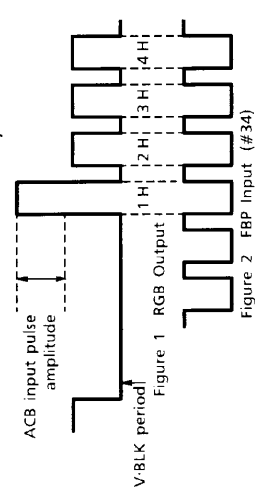

NOTE	ITEM	(TEST CONDITIONS V _{CC} = 5V and 9V, T _a = 25 ± 3°C)										MEASUREMENT METHOD	
		SW MODE & SUB ADDRESS & DATA											
		S03	S04	S05	S06	S07	S08	S09	S10	S14	S54		
T44	ACB Clamp Current	A	A	A	OFF	A	A	A	A	OFF	A	C	<ol style="list-style-type: none"> ① Set pin 17 to open, connect a 1-kΩ resistor to the pin, and apply 3V to the pin from the power supply. ② When the subaddress (11) data are set to (10), (30), (50), and (70), measure from the waveform of pin 17 the current flowing to GND during the clamp period. (I17a, I17b, I17c I17d) ③ Repeat the measurements in steps ① and ② above on pins 18 and 19. (I18a, I18b, I18c I18d) (I19a, I19b, I19c I19d)
T45	IK Input Amplitude	A	A	A	OFF	A	A	A	OFF	A	C	<ol style="list-style-type: none"> ① Connect TP13 to TP13b ; TP14 to TP14b ; TP15 to TP15b. ② Set SW20 to b. ③ Set the subaddress (11) data to (50). ④ By referring to Figure 1 of T43, determine the voltage output from pins 13, 14, and 15 (IKR, IKG, IKB) during the ACB pulse input to the signal input to pin 20. 	

NOTE	ITEM	(TEST CONDITIONS $V_{CC} = 5V$ and $9V$, $T_a = 25 \pm 3^\circ C$)									
		SW MODE & SUB ADDRESS & DATA									
		S03	S04	S05	S06	S07	S08	S09	S10	S54	<p>MEASUREMENT METHOD</p> <ol style="list-style-type: none"> Input a ramp waveform to pin 54 (Y IN) and adjust the input amplitude so that the picture period amplitude of pin 13 is $2.5 V_{p-p}$. Adjust the drive adjustment data so that the picture period amplitudes of pins 14 and 15 are equal to that of pin 13. Set the subaddress (13) data to (81). Using pins 13, 14, and 15, calculate the RGBγ start point and its gradient (in decibels) in relation to the off point, using Fig.1 below.
T46	RGB γ Correction Characteristics	A	A	A	OFF	A	A	A	OFF	A	

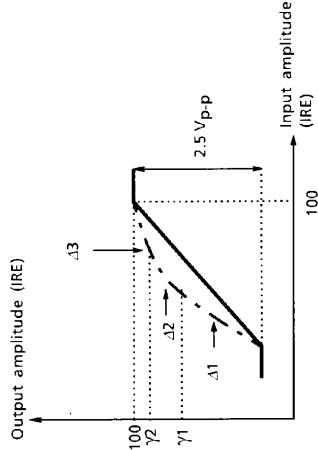

NOTE	ITEM	(TEST CONDITIONS $V_{CC} = 5V$ and $9V$, $T_a = 25 \pm 3^\circ C$)										MEASUREMENT METHOD
		SW MODE & SUB ADDRESS & DATA										
		S03	S04	S05	S06	S07	S08	S09	S10	S10	S54	
T47	VK Output Characteristics	A	A	A	ON	B	B	B	OFF	C		<ol style="list-style-type: none"> ① Input a sync signal to pin 38. ② Input a ramp waveform ($1.25 V_{p-p}$) to pins 7, 8, and 9 during the picture period. ③

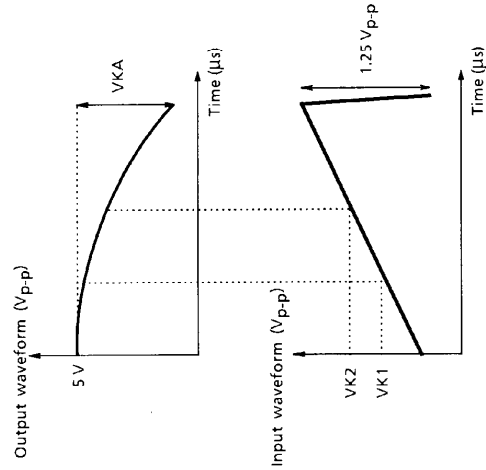

NOTE	ITEM	SYMBOL	SW MODE & SUB ADDRESS & DATA								MEASUREMENT METHOD	
			S03	S04	S05	S06	S07	S08	S09	S10		S54
T48	ACB Protection Circuit Operating monitor 1	ACBPR ACBPG	A	A	A	OFF	A	A	A	OFF	C	(TEST CONDITIONS $V_{CC} = 5V$ and $9V$, $T_a = 25 \pm 3^\circ C$) ① Set the subaddress (11) data to (A0). ② Apply 8.0V to pin 17. ③ Monitor pin 13 and confirm that the picture period has not dropped to the BLK level (ACBPR). ④ Monitor pin 14 and confirm that the picture period has not dropped to the BLK level (ACBPG)
T49	ACB Protection Circuit Operating monitor 2	ACBBRAR ACBBRAG	A	A	A	OFF	A	A	A	OFF	C	① Set the subaddress (11) data to (C0). ② Apply 8.0V to pin 17. ③ Monitor pin 13 and confirm that the picture period is at the BLK level (ACBBRAR). ④ Monitor pin 14 and confirm that the picture period is at the BLK level (ACBBRAG)
T50	ACB Protection Circuit Operating monitor 3	ACBBRLO	A	A	A	OFF	A	A	A	OFF	C	① Set the subaddress (11) data to (C0). ② Apply 6.8V to 9V V_{CC} (pin 16). ③ Apply 6.8V TO pin 17. ④ Monitor pin 13 and confirm that the picture period has not dropped to the BLK level (ACBBRLO)
T51	Base Band Tint Adjustment Characteristics	ANG RMIN ANG BMIN ANG RMAX ANG BMAX	A	A	A	OFF	ON	ON	—	OFF	C	① Change subaddress (05) H to (81) H. ② Set unicolor = max ; bright = max ; color = center. ③ Input signal 1 ($f_0 = 100$ kHz, 100 mV _{p-p}) to pin 53. ④ To pin 52, input a signal with the same amplitude but $90^\circ C$ phase advanced compared to the signal input to pin 53. ⑤ When subaddress (14) H is changed to (C0) H \rightarrow (80) H, measure the amount of change in the output phase of pin 13. (ANG RMIN) ⑥ Under the same conditions as ⑤ above, measure the amount of change in the output phase of pin 15. (ANG BMIN) ⑦ When subaddress (14) H is changed to (C0) H \rightarrow (FF), measure the amount of change in the output phase of pin 13. (ANG RMAX) ⑧ Under the same conditions as ⑦ above, measure the amount of change in the output phase of pin 15. (ANG BMAX)

NOTE	ITEM	SYMBOL	SW MODE & SUB ADDRESS & DATA								(TEST CONDITIONS $V_{CC} = 5V$ and $9V$, $T_a = 25 \pm 3^\circ C$)	
			S03	S04	S05	S06	S07	S08	S09	S10		S54
T52	Base Band Tint Adjustment Position	BUS B0	A	A	A	OFF	ON	ON	—	OFF	C	① Change subaddress (05) H to (81) H. ② Set unicolor = max ; bright = max ; color = center. Relative amplitude, phase switching: Change subaddress (12) H to (00). ③ Input signal 1 ($f_0 = 100$ kHz, 100 mV _{p-p}) to pin 53. ④ To pin 52, input a signal with the same amplitude but $90^\circ C$ phase advanced compared to the signal input to pin 53. ⑤ Changing subaddress (14) H from (C0) H, read the transmission data at subaddress (14) H when the output phase of the pin 15 signal is the same as the input phase of the pin 53 signal. (BUS B0)

Deflection stage		TEST CONDITIONS (DEF V _{CC} = 9 V, T _a = 25 ± 3°C, BUS DATA = POWER-ON RESET)		MEASUREMENT METHOD
NOTE	ITEM	SW MODE	SW	
D1	Sync separation Input Sensitivity Current	OFF	B	<p>When the number of H periods in the #33 (VD out) waveform changes from 297 to 225, increase the voltage from 3 V and measure the value at (A) in the diagram.</p> <p>When the subaddress (0D) D₁ is set to (1), measure the value at (A) in the diagram.</p>
D2	V separation Filter Pin Source Current	OFF	B	<p>When #38 (Sync in) is connected to GND, measure the #39 (VSEP FILTER) voltage.</p>
D3	V Separation Level	OFF	B	<p>Set the voltage to around 7.5 V, equivalent to when #40 (AFC1 FILTER) has no load. When a signal as shown in the diagram below is input to #38 (Sync in) from TG7, calculate V₁ and V₂ using the #40 waveform.</p> <p> $I_{DET} = V_1 \div 1 \text{ k}\Omega (\mu\text{A})$ $\Delta I_{DET} = (V_1 / V_2 - 1) \times 100 (\%)$ </p>
D4	H AFC Phase Detection Current H AFC Phase Detection Current Ratio	OFF	A	<p>Input a composite video signal to #38 and measure the V mask period of the #40 (AFC1 FILTER) waveform.</p>
D5	Phase Detection Stop Period	OFF	A	

TA1310AN

D5 : Phase detection stop period

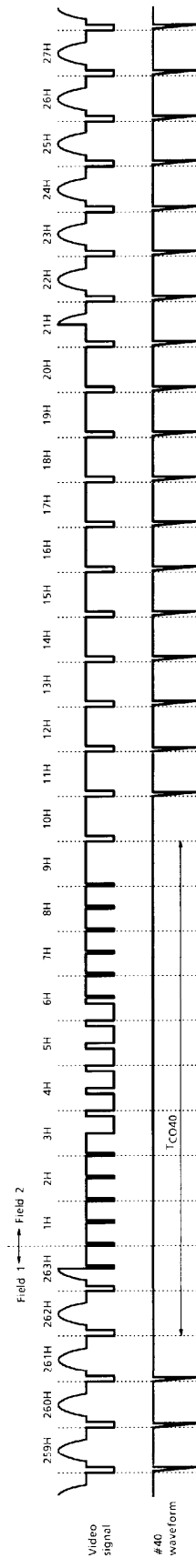
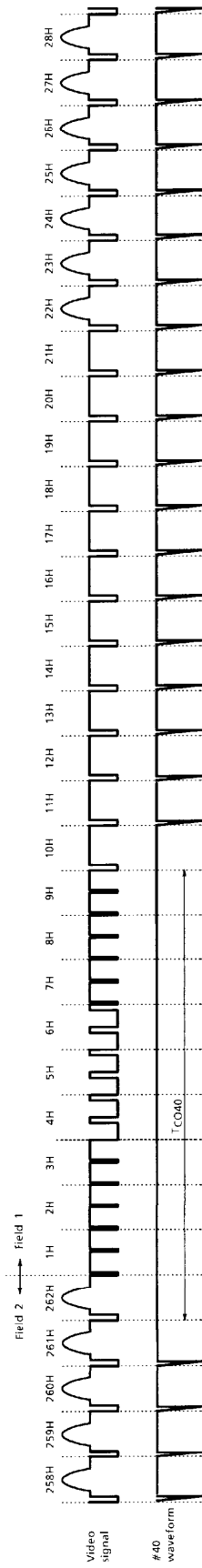

TA1310AN-77

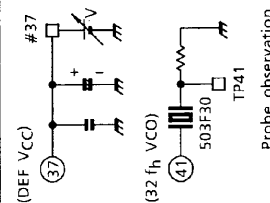
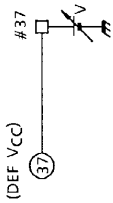
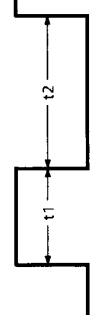
NOTE	ITEM	TEST CONDITIONS (DEF V _{CC} = 9 V, T _a = 25 ± 3°C, BUS DATA = POWER-ON RESET)		MEASUREMENT METHOD
		SW MODE	SW ₃₄ SW ₃₈	
D6	32*f _H VCO Oscillation Start Voltage	OFF	B	<p>Increase the voltage from 2.5 V. When an oscillation waveform appears on TP41, measure the voltage. At the same time, check that no waveform is output (0V DC) to #35 (H out). (Apply only DEF V_{CC}.)</p>  <p>(DEF V_{CC}) #37 (32 f_H VCO) #37 503F30 TP41 Probe observation</p>
D7	Horizontal Output Start Voltage	OFF	B	<p>Increase the voltage. When a horizontal pulse appears on #35 (H out), measure the voltage. Note that the horizontal oscillation frequency at this time is near f_{HO} (15.7 kHz ± 1 kHz). (Apply only DEF V_{CC}.)</p> <ol style="list-style-type: none"> Under the above conditions, when no horizontal pulse is output on #35, read D₄ in bus read mode. (Apply also the chroma V_{CC}.) (VBUS HOFF) Under the above conditions, when a horizontal pulse is output on #35, read D₄ in bus read mode. (Apply also the chroma V_{CC}.) (VBUS HON)  <p>(DEF V_{CC}) #37</p>
D8	Horizontal Output Pulse Duty	OFF	B	<p>Observe the #35 (H out) waveform and measure t₁ and t₂.</p>  $TH_{35} = \frac{t_1}{t_1 + t_2} \times 100 (\%)$
D9	Phase Detection Stop Mode	OFF	B	<p>Input a composite video signal to TP38. When the subaddress (0D) D₁ is set to (1), measure the oscillation frequency of the #35 (H out) waveform.</p>
D10	Horizontal Free-Run Frequency	OFF	B	<p>Measure the oscillation frequency of #35 (H out).</p>
D11	Horizontal Oscillation Frequency Range	OFF	B	<ol style="list-style-type: none"> When #40 (AFC1 FILTER) is connected to DEF V_{CC} via a 10-kΩ resistor, measure the #35 (H out) oscillation frequency. (VHMIN) When #40 (AFC1 FILTER) is connected to GND via a 68-kΩ resistor, measure the #35 (H out) oscillation frequency. (VHMAX)
D12	Horizontal Oscillation Control Sensitivity	OFF	B	<p>When the voltage on #40 (AFC1 FILTER) is varied by ±0.05 V with a horizontal oscillation frequency of 15.734 kHz, calculate the #35 (H out) frequency variation rate.</p>

TEST CONDITIONS (DEF V _{CC} = 9 V, T _a = 25 ± 3°C, BUS DATA = POWER-ON RESET)		MEASUREMENT METHOD	
NOTE	ITEM	SW MODE SW34, SW38	
D13	Horizontal Output Voltage	OFF	<p>① Measure the high-level voltage of #35 (H out) (when #35 is connected to GND via a 481-Ω resistor). (V_{H35})</p> <p>② Measure the low-level voltage of #35 (H out) (when #35 is connected to GND via a 481-Ω resistor). (V_{L35})</p> <p>When the #37 (DEF V_{CC}) voltage is varied from 8.5 V, to 9.5 V, measure the variation in the #35 (H out) oscillation frequency.</p>
D14	Supply Voltage Dependence of Horizontal Oscillation Frequency	OFF	<p>When the temperature is varied through the range -20°C to +60°C, measure the variation in the #35 (H out) oscillation frequency.</p>
D15	Temperature Dependence of Horizontal Oscillation Frequency	OFF	<p>When a signal as shown at left is input to TP38 from TG7, measure the phase difference of the #34 (FBP in) waveform in relation to the #40 (AFC1 FILTER) waveform (SPH1). Also measure the phase difference of the #40 waveform in relation to the center of the input horizontal sync signal (SPH2).</p>
D16	Horizontal Sync Phase	OFF	<p>Under the above conditions, when the subaddress (0B) D7 to D3 are varied from (00000) to (11111), measure the phase variation in the #34 (FBP in) waveform.</p>
D17	Horizontal Picture Phase Adjustment Range	OFF	<p>Under the above conditions, when the subaddress (0B) D7 to D3 are varied from (00000) to (11111), measure the phase variation in the #34 (FBP in) waveform.</p>

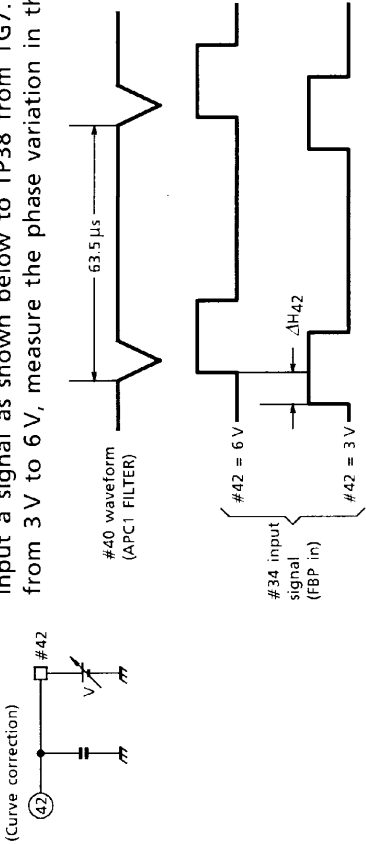
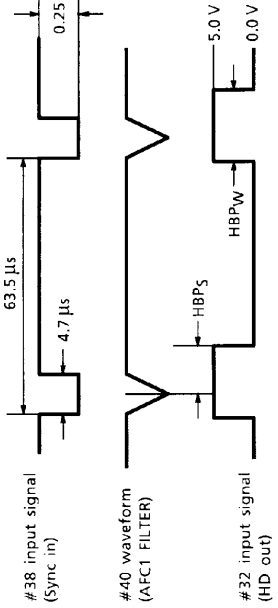
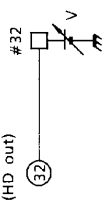
TEST CONDITIONS (DEF V _{CC} = 9 V, T _a = 25 ± 3°C, BUS DATA = POWER-ON RESET)		MEASUREMENT METHOD	
NOTE	ITEM	SW MODE SW34, SW38	
D18	Horizontal Blanking Pulse Threshold	ON	<p>Decrease the amplitude of #34 (FBP in) from 9 V_{p-p}. When AFC2 stops locking, measure the amplitude. (V_{HBLK1})</p> <p>Increase the amplitude of #34 (FBP in) from 0 V_{p-p}. When horizontal blanking is applied to #13 (R in), measure the amplitude. (V_{HBLK2})</p> 
D19	Curve Correction Range	OFF	<p>Input a signal as shown below to TP38 from TG7. When the voltage is varied from 3 V to 6 V, measure the phase variation in the #34 (FBP in) waveform.</p> 
D20	H Cycle Black Peak Detection Disable Pulse	OFF	<p>Set the subaddress (01) D7 to (0), set the subaddress (05) D3~D1 to (010), and set the subaddress (0C) D0 to (1).</p> <p>When a signal as shown at left is input to TP38 from TG7, measure the #32 (HD out) waveform phase difference HBPW and pulse width HBPW in relation to the #40 (AFC1 FILTER) waveform.</p> 
D21	Threshold of External Black Peak Detection Disable Pulse	OFF	<p>Set the subaddress (02) D7 to (1).</p> <p>Increase the voltage from 0 V. When #52 reaches 3.4 V DC, measure the voltage.</p> 

TEST CONDITIONS (DEF V _{CC} = 9 V, T _a = 25 ± 3°C, BUS DATA = POWER-ON RESET)		MEASUREMENT METHOD	
NOTE	ITEM	SW MODE SW ₃₄ SW ₃₈	
D22	Clamp Pulse Start Phase Clamp Pulse Width	OFF A	<p>(R in) #13</p> <p>Set the subaddress (01) D7 to (0), set the subaddress (05) D3~D1 to (010), and set the subaddress (0C) D0 to (1).</p> <p>Input a signal as shown at left to TP38 from TG7, then measure the #32 (HD out) waveform phase difference CPs and pulse width CPw in relation to the #40 (AFC1 FILTER) waveform.</p>
D23	HD Output Start Phase HD Output Pulse Width HD Output Amplitude	OFF A	<p>Input a signal as shown at left to TP38 from TG7, then measure the #32 (HD out) waveform phase difference HDs and pulse width HDw and VHD in relation to the #40 (AFC1 FILTER) waveform.</p>
D24	Gate Pulse Start Phase Gate Pulse Width	OFF A	<p>Input a signal as shown at left to TP38 from TG7, then measure the #34 (FBP in) waveform phase difference GPw and pulse width GPw in relation to the #40 (AFC1 FILTER) waveform.</p>

TA1310AN

D24 : Gate pulse V mask period

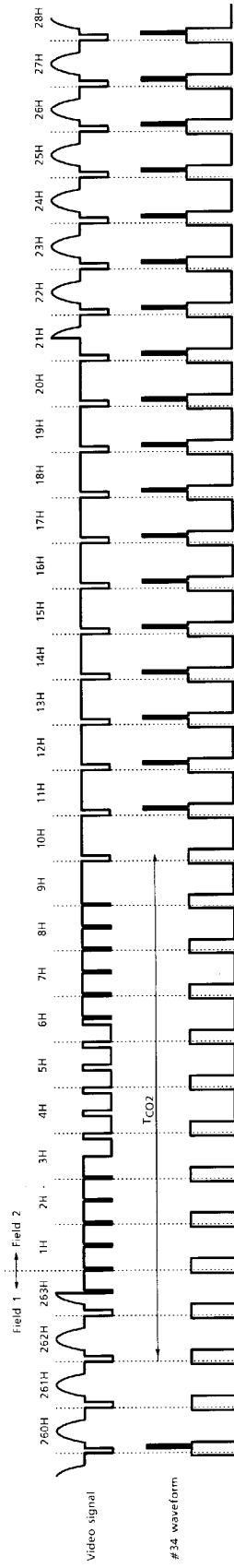
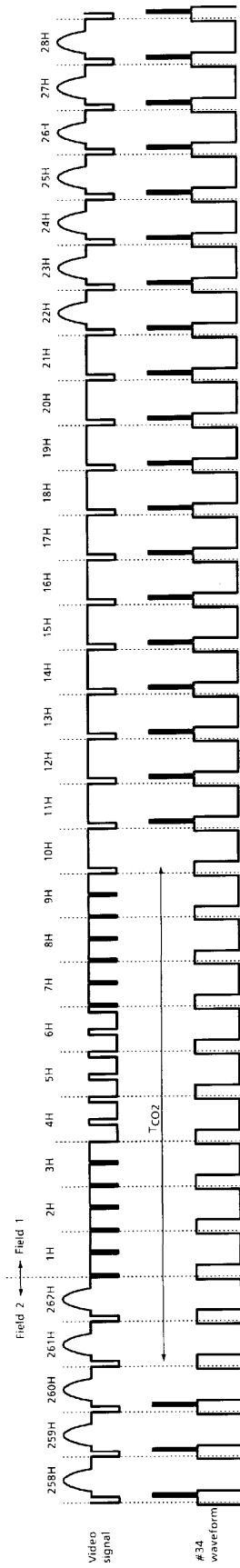

TA1310AN-82

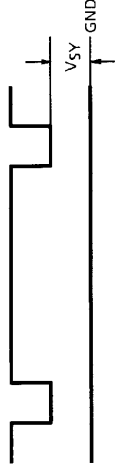
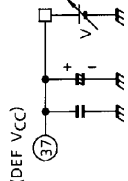
NOTE		ITEM	TEST CONDITIONS (DEF V _{CC} = 9 V, T _a = 25 ± 3°C, BUS DATA = POWER-ON RESET)		MEASUREMENT METHOD
			SW MODE	SW34	
D25	Gate Pulse V Mask Period	OFF	SW34	OFF	Input a composite video signal to TP38, observe the #34 (FBP in) waveform, and measure the V mask period.
D26	Sync Out Low Level	OFF		A	<p>Input a composition video signal to TP38, observe the #36 (Sync out) waveform, and measure the low level of the sync period.</p> 
D27	Vertical Oscillation Start Voltage	OFF		B	<p>Increase the voltage from 0 V. When a pulse is output from #33 (VD out), measure the voltage. (Apply only DEF V_{CC}.)</p> 
D28	Vertical Free-Run Frequency	OFF		B	Measure the frequency of #33 (VD out).
D29	Vertical Output Voltage	OFF		B	<ol style="list-style-type: none"> Measure the high level voltage of the #33 (VD out) waveform. (V_{VH}) Measure the low level voltage of the #33 (VD out) waveform. (V_{VL})
D30	Service Mode Switching	OFF		B	When the subaddress (0C) D ₀ is set to (1), check that the #27 (V.Ramp) waveform is low (3.4 V DC).
D31	Vertical Pull-In Range	OFF		C	Input a composite video signal to TP38, vary the vertical frequency of this signal in 0.5-H steps, and measure the vertical pull-in range.
D32	Vertical Frequency Forced 263H Vertical Frequency Forced 262.5H	OFF		B	<ol style="list-style-type: none"> Measure the number of H periods of #33 (HD out) when the subaddress (0D) D₁ and D₀ are set to (10). (f_{V1}) Measure the number of H periods of #33 (HD out) when the subaddress (0D) D₁ and D₀ are set to (11). (f_{V2})
D33	Vertical Blanking Off Mode	OFF		B	Set the subaddress (01) D ₇ to (1) and check that no vertical or horizontal blanking pulse is applied to #13 (R out), #14 (G out), or #15 (B out).

NOTE	ITEM	TEST CONDITIONS (DEF V _{CC} = 9V, Ta = 25 ± 3°C, BUS DATA = POWER-ON RESET)	
		SW MODE	MEASUREMENT METHOD
D34	Vertical Output Pulse Width	SW ₃₄ SW ₃₈ OFF	Input a composite video signal to TP38, then measure the #33 (VD out) vertical pulse delay T _D and pulse width T _W in relation to the vertical sync signal of #38 (Sync in).
D35	RGB Output Vertical Blanking Pulse Start Phase RGB Output Vertical Blanking Pulse Stop Phase	OFF	Input a composite video signal to TP38, then measure the #13 (R out) waveform phase difference VR _{S1} and pulse width VR _{S2} in relation to the #38 (Sync in) waveform. Repeat measurement on #14 and #15. Set the subaddress (11) D ₄ ~D ₁ to (1111) and the subaddress (12) D ₄ ~D ₁ to (1111).
D36	V Cycle Black Peak Detection Disable Pulse (Normal)	OFF	Input a composite video signal to TP38 and measure the V cycle black peak detection disable pulse period of #55 (BLACK PEAK DET).
D37	V Cycle Black Peak Detection Disable Pulse (Zoom)	OFF	Under the conditions in D38 above, set the subaddress (0C) D ₁ to (1) and measure the V cycle black peak detection disable period of #55.

D34 : Vertical output pulse width, vertical output pulse phase variation, and vertical output pulse phase range

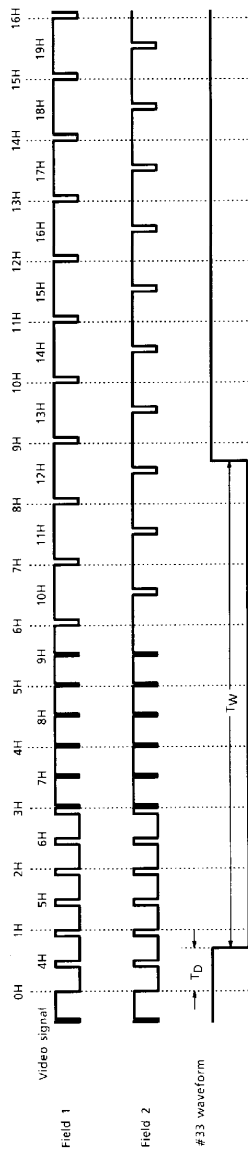

D35 : RGB output vertical blanking pulse start and stop phases

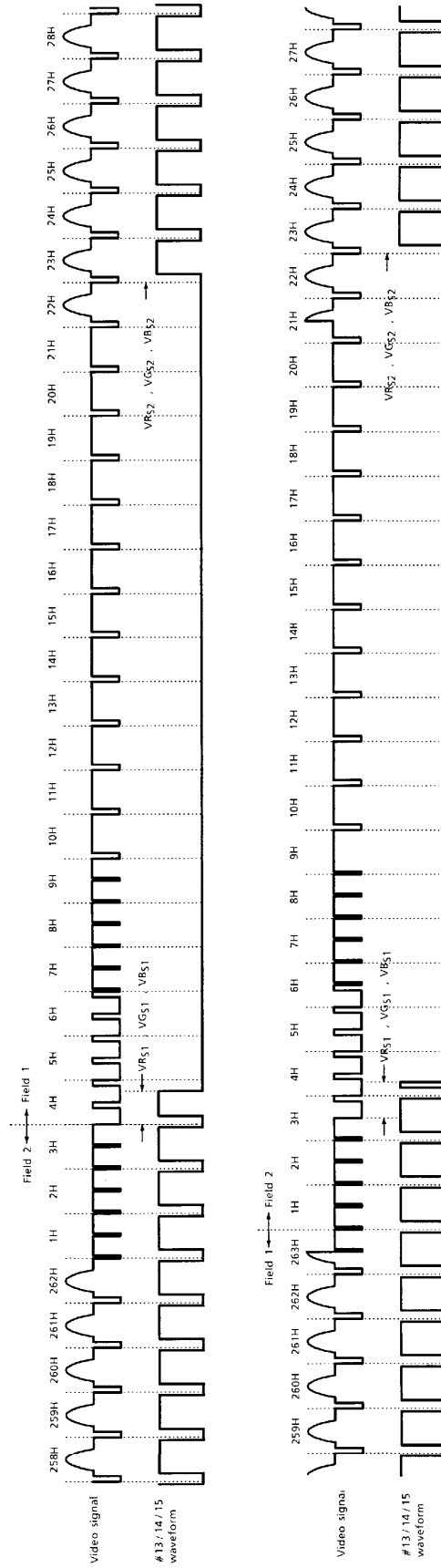

D36 : Video mute period (normal)

Field 2 to field 1

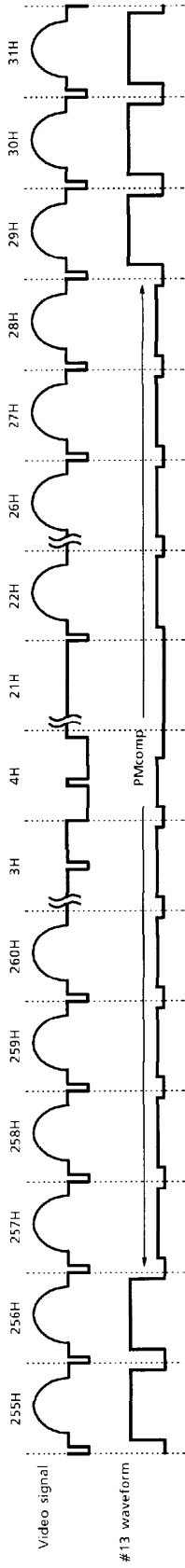

Field 1 to field 2

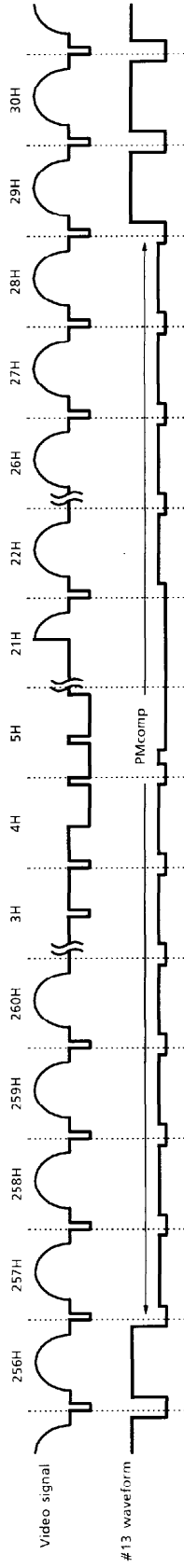

D37 : Video mute period (zoom)

Field 2 to field 1

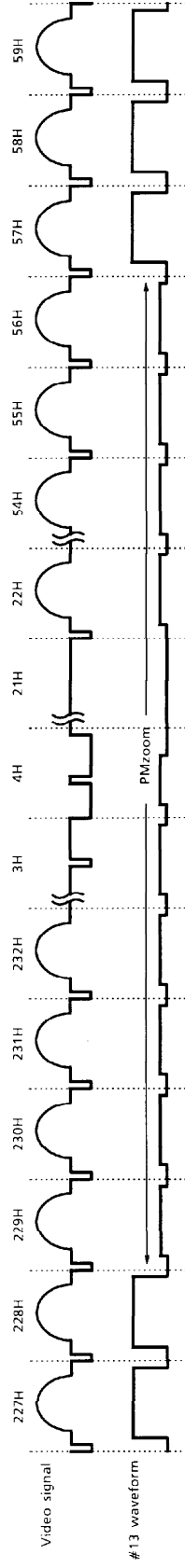

Field 1 to field 2

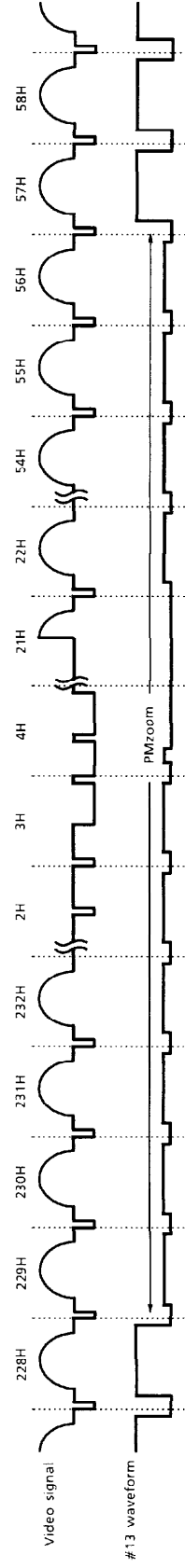

D38 : V cycle black peak detection disable pulse (normal)

Field 2 to field 1

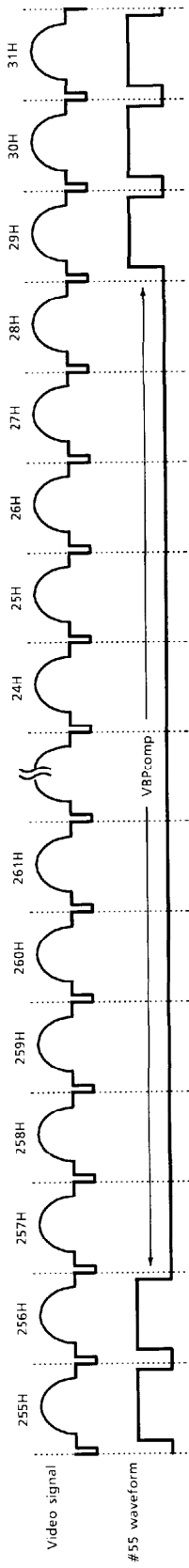

Field 1 to field 2

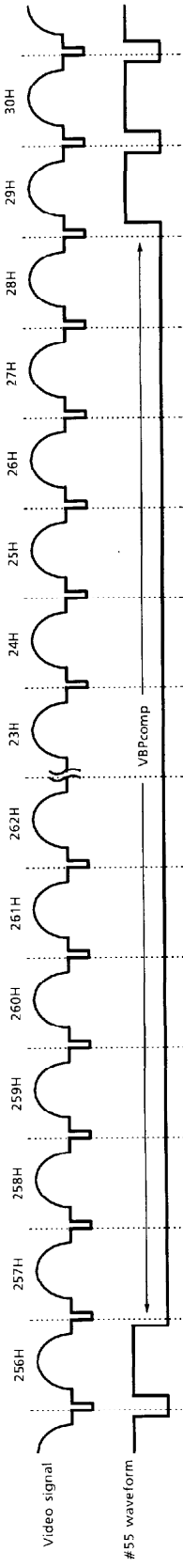

D39 : V cycle black peak detection disable pulse (zoom)

Field 2 to field 1

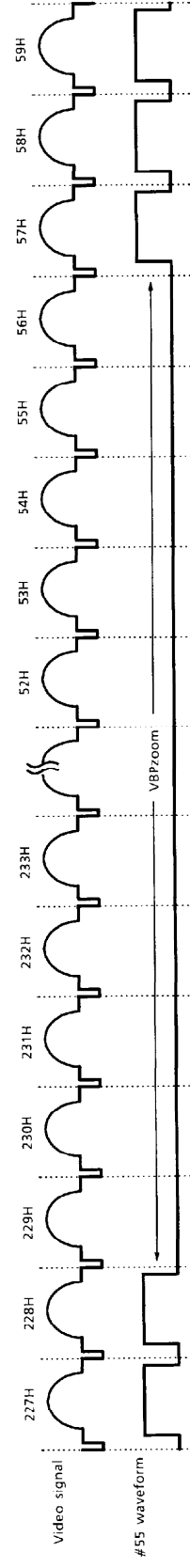

Field 1 to field 2

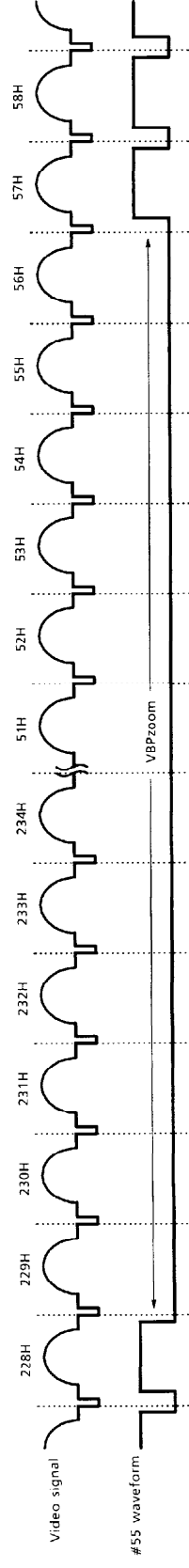

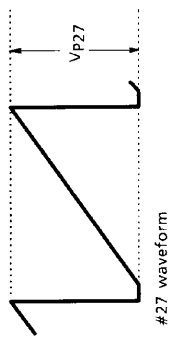
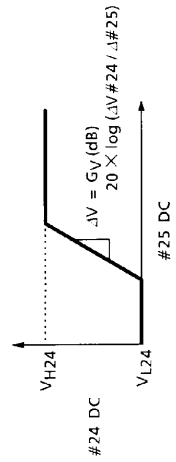
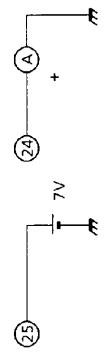
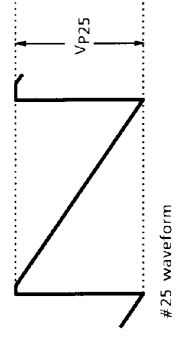

Deflection correction stage

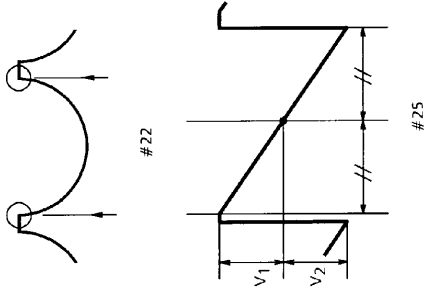
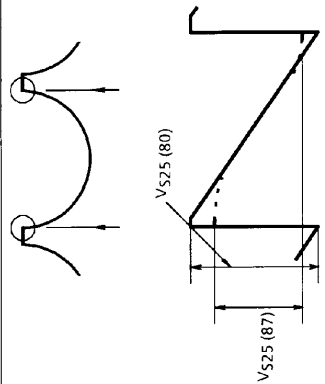
TEST CONDITIONS (DEF V _{CC} = 9 V, T _a = 25 ± 3°C, BUS DATA = POWER-ON RESET)		MEASUREMENT METHOD	
NOTE	ITEM	SW MODE SW28	
G1	Vertical Ramp Amplitude	A	 <p>Measure the amplitude of the vertical ramp wave on #27.</p>
G2	Vertical Amplification	A	 <p>Set #24 and #25 to open. Set the subaddress (0C) data to (81). Connect #25 to an external power supply. When the voltage is varied from 5.5 V to 6.5 V, measure the vertical amplification on the #24 voltage. (GV) (VH24) (VL24)</p>
G3	Vertical Amp Maximum Output Voltage	A	 <p>Set #24 and #25 to open. Apply 7 V to #25 from an external source. Insert an ammeter between #24 and GND, and measure the current.</p>
G4	Vertical Amp Minimum Output Voltage	A	
G5	Vertical Amp Maximum Output Current	A	 <p>Measure the amplitude of the #25 waveform (vertical sawtooth waveform).</p>
G6	Vertical NF Sawtooth Wave Amplitude	A	<p>When the subaddress (0C) data are set to (00) and (FC), measure the amplitudes of the #25 waveform (vertical sawtooth waveform) VP25 (00) and VP25 (FC).</p> $V_{PH} = \pm \frac{VP25 (FC) - VP25 (00)}{VP25 (FC) + VP25 (00)} \times 100 (\%)$
G7	Vertical Amplitude Range	A	

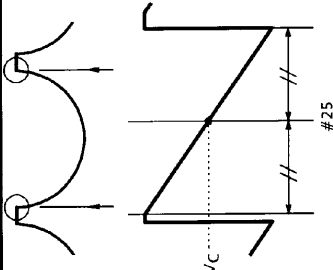
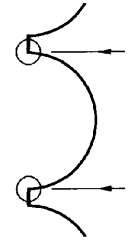
TEST CONDITIONS (DEF V _{CC} = 9 V, T _a = 25 ± 3°C, BUS DATA = POWER-ON RESET)	
NOTE	MEASUREMENT METHOD
	SW MODE SW28
G8	<p>Vertical Linearity Correction Maximum Value</p> <p>Set the subaddress (0E) data to (F8). Change the subaddress (10) D7~D4 so that the #22 parabola waveform is symmetrical. Set the subaddress (0E) data to (00). When the subaddress (0F) data are (80), measure the #25 waveform V1 (80) and V2 (80). Likewise, when the subaddress (0F) data are (00) and (F0), measure V1 (00), V2 (00), V1 (F0), and V2 (F0).</p> $V_l = \pm \frac{V1(00) - V1(F0) + V2(F0) - V2(00)}{2 \times (V1(80) + V2(80))}$ 
G9	<p>Vertical S Correction Maximum Value</p> <p>Set the subaddress (0E) data to (F8). Change the subaddress (10) D7~D4 so that the #22 parabola waveform is symmetrical. Set the subaddress (0E) data to (00). When the subaddress (0E) data are (80), measure the amplitude of the #25 waveform V_{S25} (80). Likewise, when the subaddress (0E) data are (87), measure the amplitude of the #25 waveform V_{S25} (87).</p> $V_s = \pm \frac{V_{S25}(80) - V_{S25}(87)}{V_{S25}(80)} \times 100 (\%)$ 

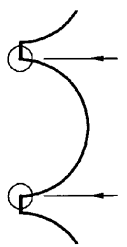
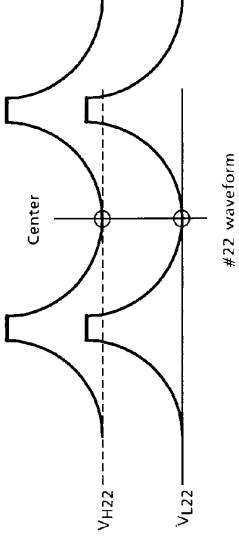
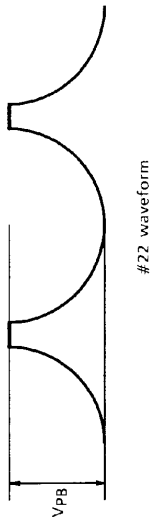
TEST CONDITIONS (DEF V _{CC} = 9 V, Ta = 25 ± 3°C, BUS DATA = POWER-ON RESET)		MEASUREMENT METHOD	
NOTE	ITEM	SW MODE SW28	
G10	Vertical NF Center Voltage	A	<p>Set the subaddress data (0E) to (F8). Change the subaddress (10) D7~D4 so that the #22 parabola waveform is symmetrical. Set the subaddress data (0E) to (00). Measure the center voltage V_C of the #25 waveform.</p> 
G11	Vertical NF DC Change	A	<p>Under the conditions in G10 above, set the subaddress (13) data to (80) and measure the vertical NF center voltage V_C (80). Next, set the subaddress (13) data to (00) and measure the vertical NF center voltage V_C (00). $V_{DC} = \pm V_C(00) - V_C(80)$ (V)</p>
G12	Vertical Amplitude EHT Correction	A	<p>Set the subaddress (0E) data to (F8). Change the subaddress (10) D7~D4 so that the #22 parabola waveform is symmetrical. Set the subaddress (0E) data to (00). Connect #28 to GND and measure the amplitude of the #25 waveform V_{EHT} (0V). Connect #28 to a 5-V power supply and measure the amplitude of the #25 waveform V_{EHT} (5 V). $VEHT = \frac{VEHT(5V) - VEHT(0V)}{VEHT(5V)} \times 100 (\%)$</p> 

TEST CONDITIONS (DEF V _{CC} = 9 V, T _a = 25 ± 3°C, BUS DATA = POWER-ON RESET)	
NOTE	MEASUREMENT METHOD
	<p>SW MODE SW28</p>
G13	<p>E-W NF Maximum DC Value (Picture Width)</p> <p>Set the subaddress (0E) data to (F8). Change the subaddress (10) D7~D4 so that the #22 parabola waveform is symmetrical. Set the subaddress (0E) data to (00). Set the subaddress (0D) data to (00) and measure the #22 voltage V_{L22}. Set the subaddress (0D) data to (FC) and measure the #22 voltage V_{H22}.</p> 
G14	<p>E-W NF Minimum DC Value (Picture Width)</p> <p>A</p> 
G15	<p>E-W NF Parabola Maximum Value (Parabola)</p> <p>A</p> <p>Set the subaddress (0D) data to (00) and the subaddress (0E) data to (F8). Measure the amplitude of the #22 waveform (parabola waveform) V_{PB}.</p> 

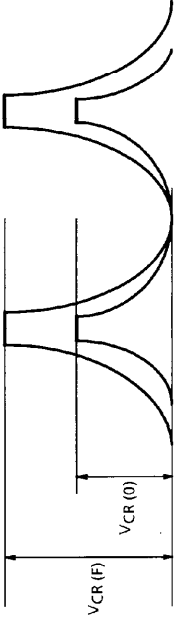
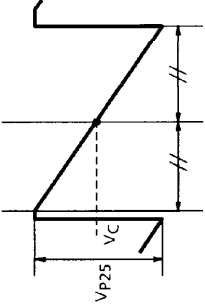
TEST CONDITIONS (DEF V _{CC} = 9 V, T _a = 25 ± 3°C, BUS DATA = POWER-ON RESET)	
NOTE	MEASUREMENT METHOD
ITEM	SW MODE SW28
G16	<p>E-W NF Corner Correction (Corner)</p> <p>A</p> <p>Set the subaddress (0E) data to (F8). Change the subaddress (10) D7~D4 so that the #22 parabola waveform is symmetrical.</p> <p>Set the subaddress (10) D3~D0 to (0) and measure the amplitude of the #22 waveform V_{CR(0)}. Likewise, when the subaddress (10) data are set to (F), measure the #22 waveform amplitude V_{CR(F)}.</p> $V_{CR} = V_{CR(F)} - V_{CR(0)}$  
G17	<p>Parabola Symmetry Correction</p> <p>A</p> <p>Set the subaddress (10) data to (00) and measure the vertical NF center voltage of the #25 waveform V_{C(00)}. Likewise, when the subaddress (10) data are set to (FC), measure the #25 voltage V_{C(FC)}.</p> $V_{TR} = \pm \frac{V_C(00) - V_C(FC)}{2 \times V_{p25}} \times 100 (\%)$ 

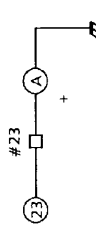
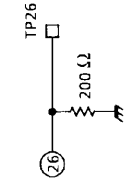
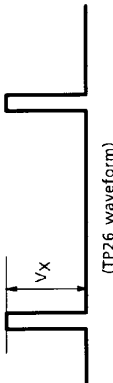
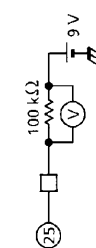
TEST CONDITIONS (DEF V _{CC} = 9 V, T _a = 25 ± 3°C, BUS DATA = POWER-ON RESET)		MEASUREMENT METHOD	
NOTE	ITEM	SW MODE SW28	
G18	E-W Amp Maximum Output Current	A	<p>Connect an ammeter between #23 and GND. Measure the current.</p> 
G19	AGC Operating Current 1	A	<p>Measure the TP26 waveform peak value. (V_{AGC0}) Set the subaddress (06) D₀ to (1) and repeat the measurement. (V_{AGC1})</p>  <p>$I_{AGC0} = V_X \div 200 (\mu A)$ (I_{AGC1})</p> 
G20	AGC Operating Current 2	A	
G21	Vertical Guard Voltage	A	Set #25 to open. Connect an external power supply to #25. Decrease the voltage from 5 V. When full blanking is applied to #13, measure the voltage.
G22	E/W Output Self-Diagnosis	A	Connect a 5-V external power supply to #23. Read D ₂ in bus read mode. (V _{BUS EWOFF}) When the external power supply connected to #23 is disconnected, read D ₂ in bus read mode. Ensure that an E/W waveform is output from #22. (V _{BUS EWON})
G23	V-Out Output Self-Diagnosis	A	Connect a 9-V external power supply to #24. Read D ₃ in bus read mode. (V _{BUS VOFF}) When the external power supply connected to #24 is disconnected, read D ₃ in bus read mode. Ensure that a V-out waveform is output from #25. (V _{BUS VON})
G24	Vertical Blanking Check	A	<ol style="list-style-type: none"> Set the subaddress (0C) data to (81). When the subaddress (11) D₄~D₀ are changed from 0000 to 1111, check that the #13 blanking stop phase begins. (V_{BLK1}) When the subaddress (12) D₄~D₀ are changed from 0000 to 1111, check that the #13 blanking start phase begins. (V_{BLK2})
G25	V Centering DAC Output	A	<ol style="list-style-type: none"> Set the subaddress (13) data to (00) and measure the #21 voltage V_{21L}. Set the subaddress (13) data to (80) and measure the #21 voltage V_{21M}. Set the subaddress (13) data to (FE) and measure the #21 voltage V_{21H}.
G26	V NFB Pin Input Current	A	<p>Connect a 9-V V_{CC} via a 100-kΩ resistor to #25. Measure the sink current on #25 according to the voltage difference of the 100-kΩ resistance.</p>  <p>$I_{25} = V / 100 k\Omega$</p>

① Input signal C-1

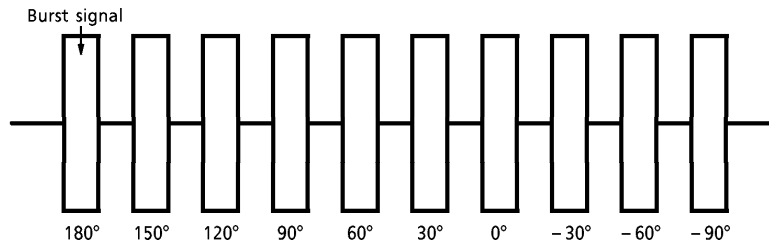

② Input signal C-2

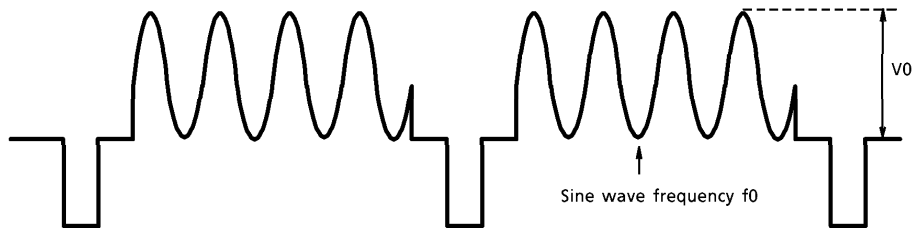

③ Input signal C-3



Fig.C Test signals for TA1310N chroma, color difference, and Y stage

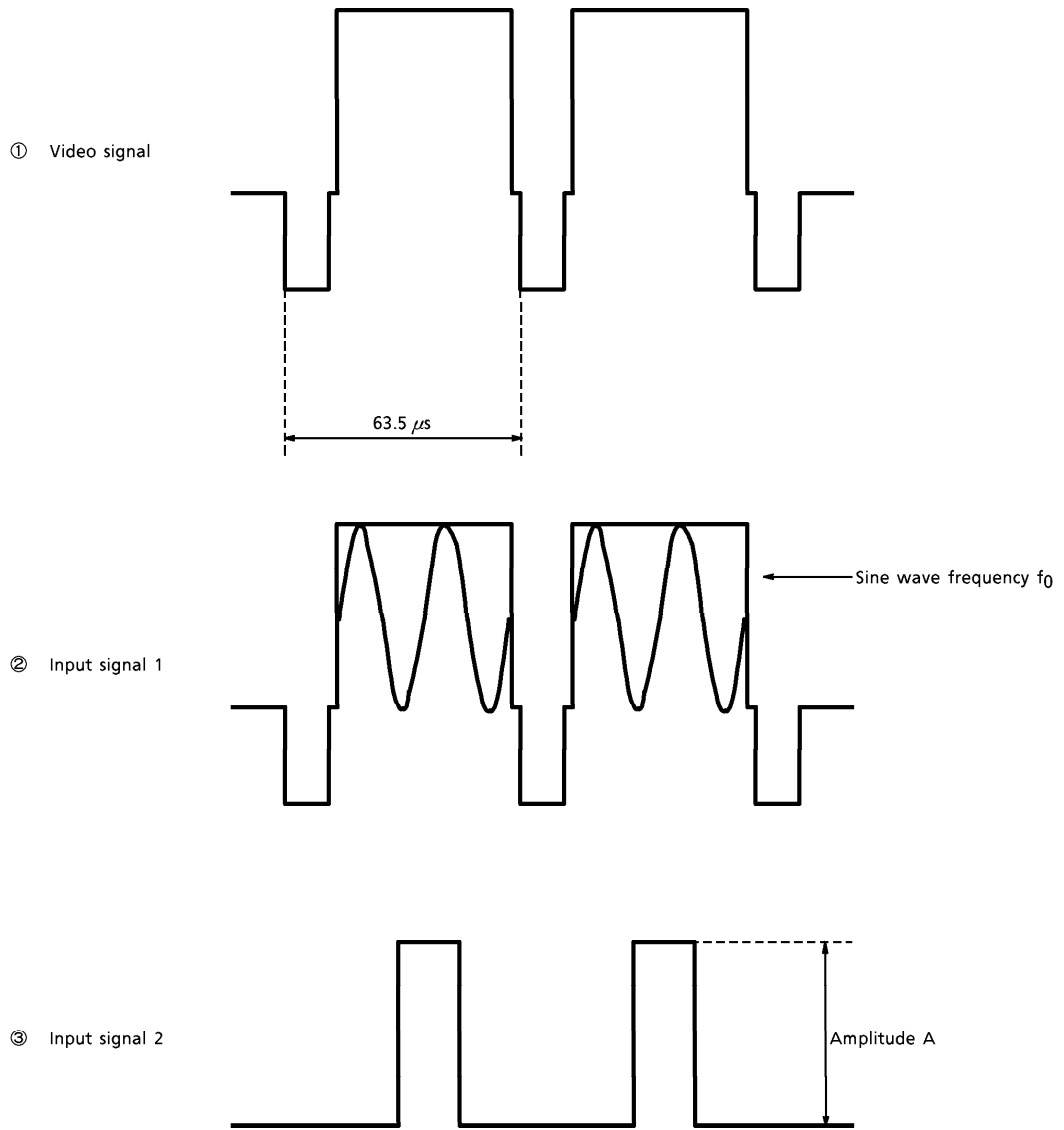

Fig.T-1 Test signals for TA1310N text stage

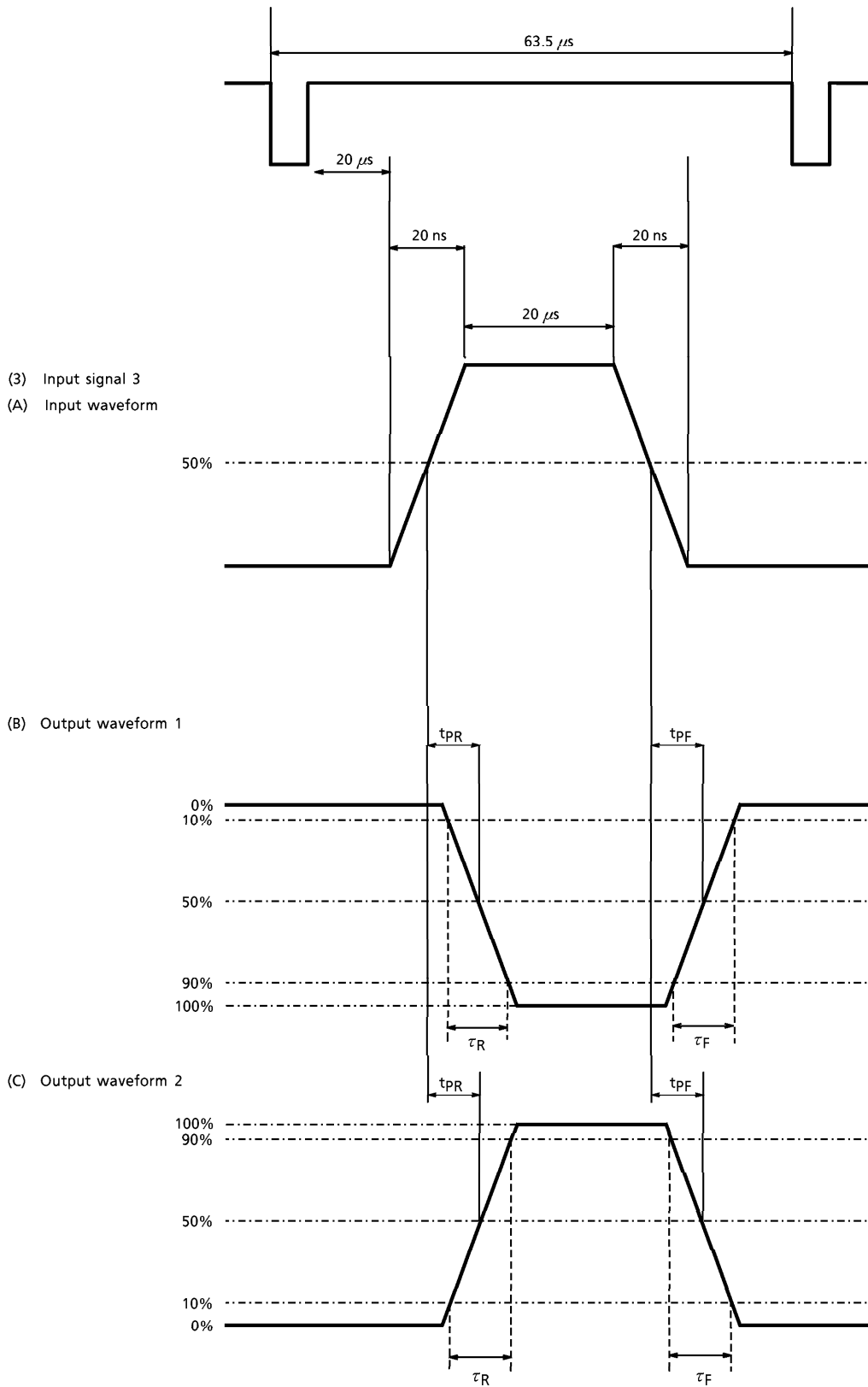
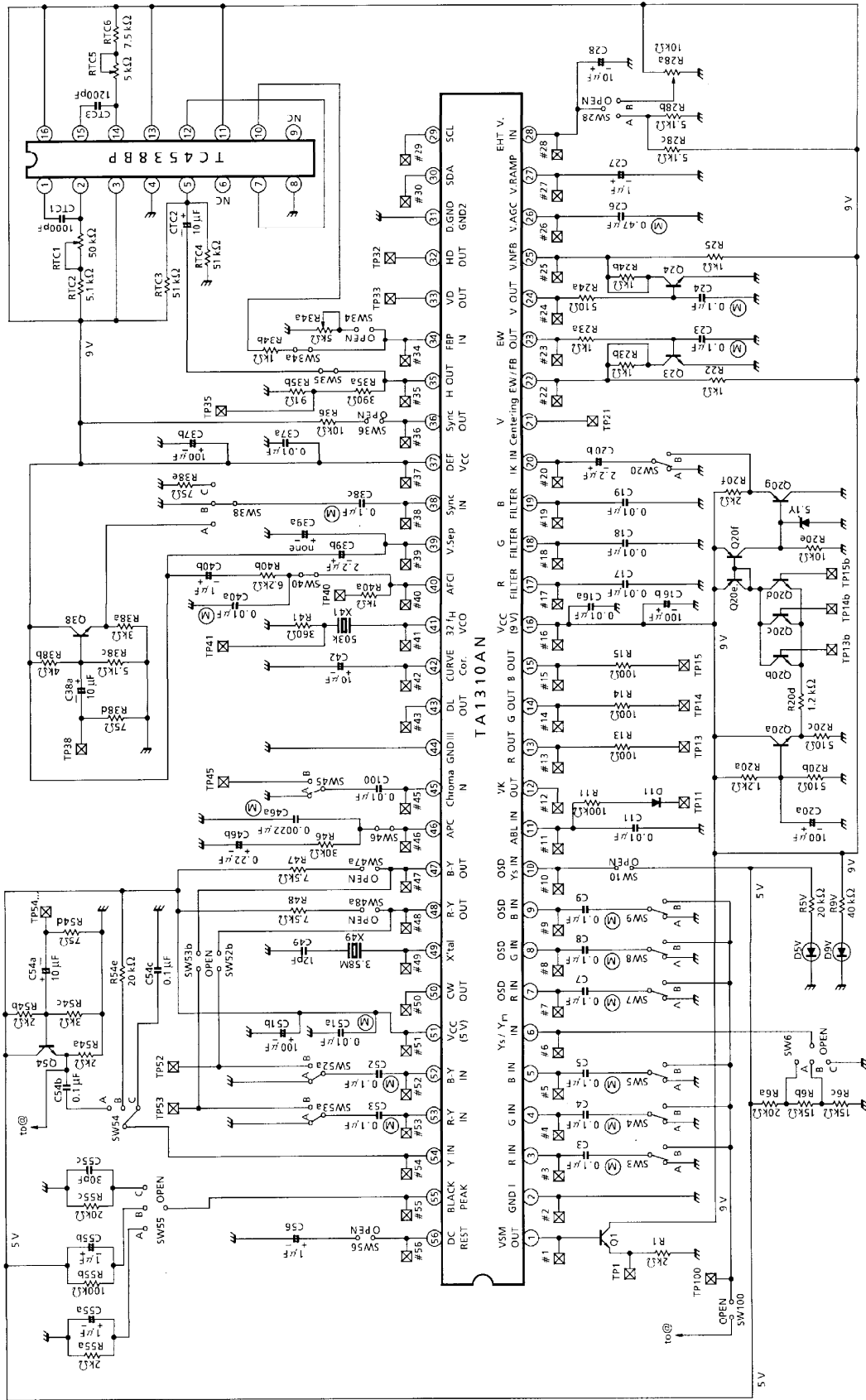
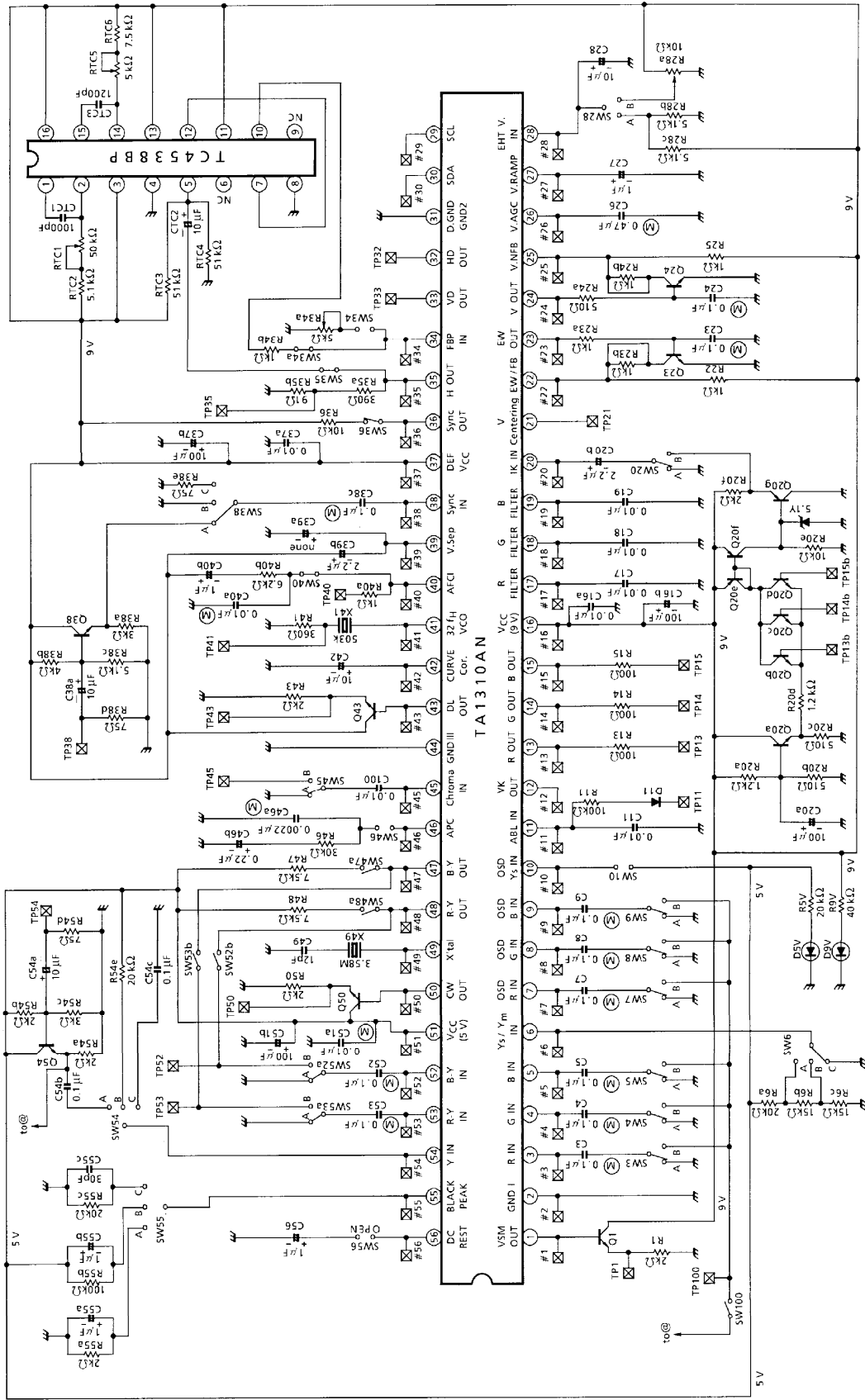

Fig.T-2 Test pulses for TA1310N test stage

TEST CIRCUIT
DC



TEST CIRCUIT
AC characteristics for picture sharpness stage



TEST CIRCUIT
Chroma stage

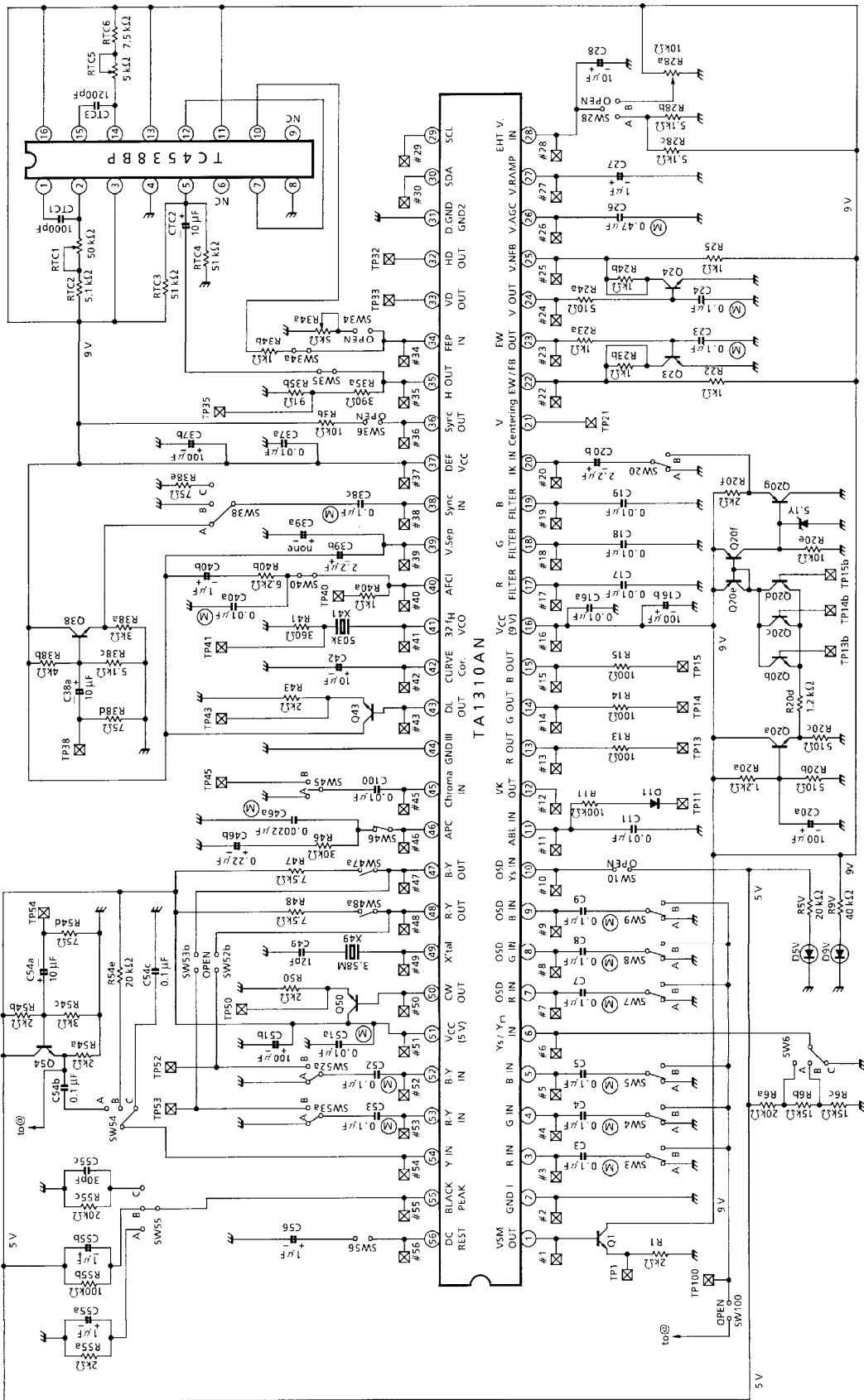

TEST CIRCUIT
Color difference stage

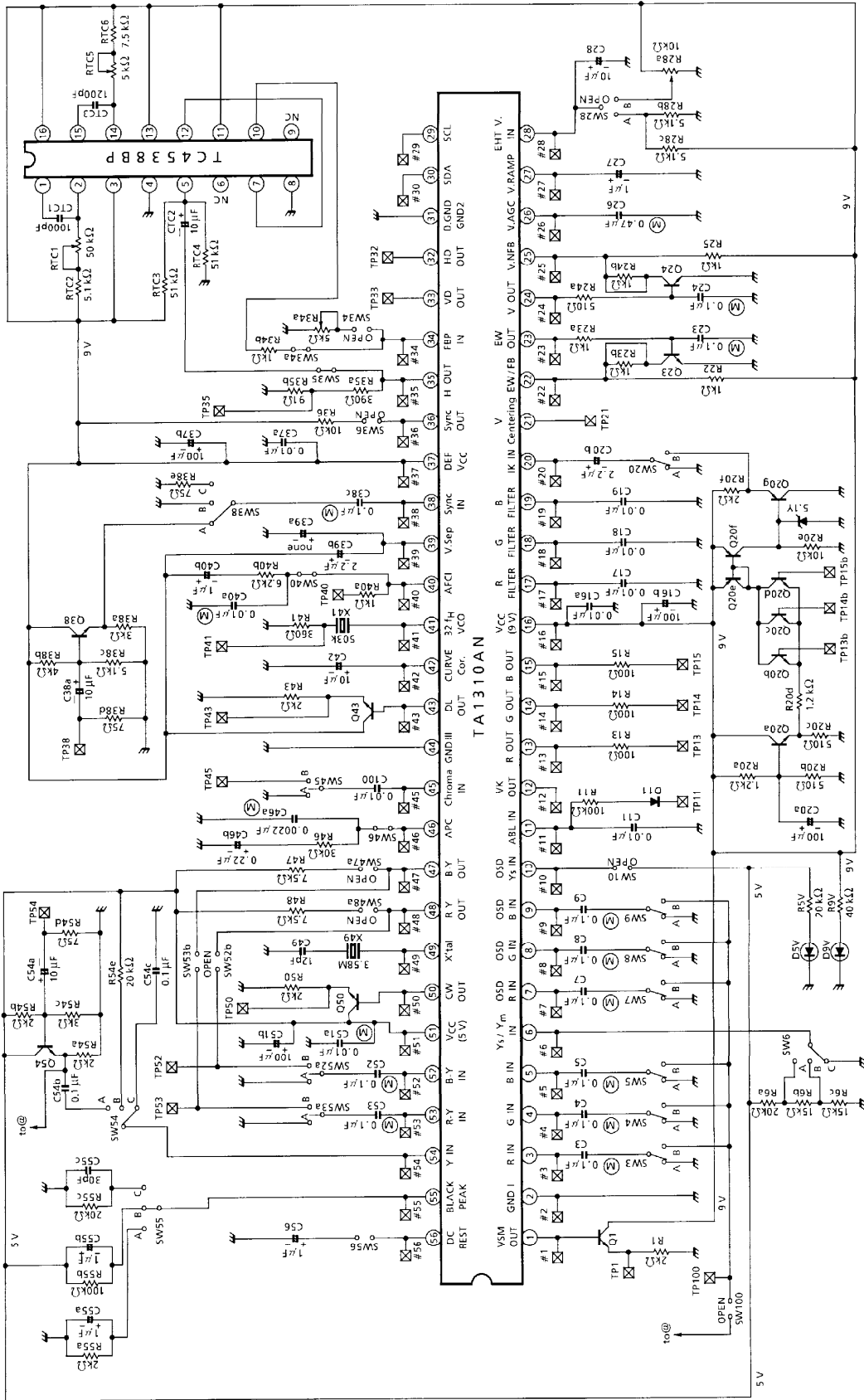

TA1310AN

TEST CIRCUIT
Y stage

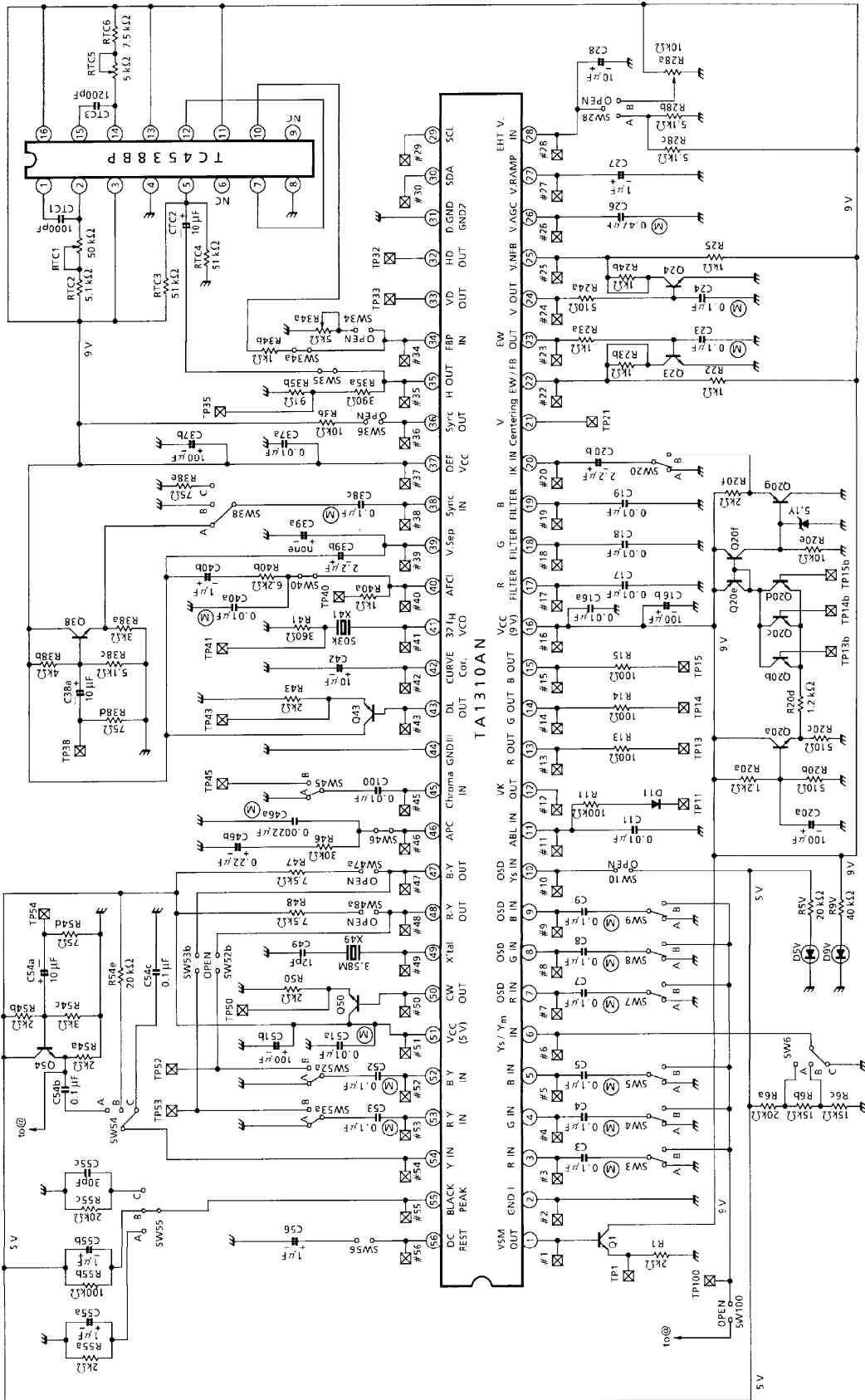

TEST CIRCUIT
Deflection stage and deflection correction stage

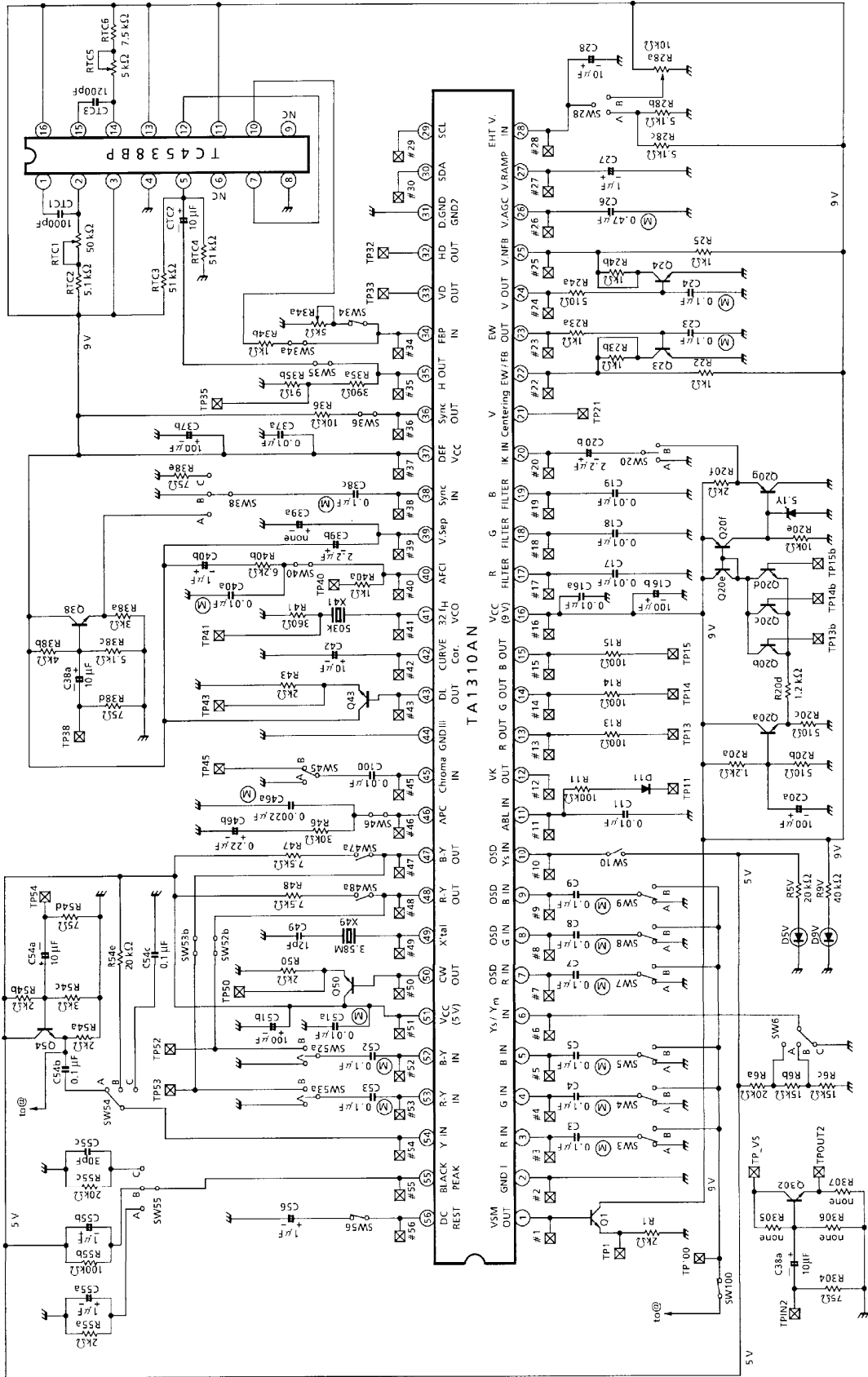

TA1310AN

APPLICATION CIRCUIT

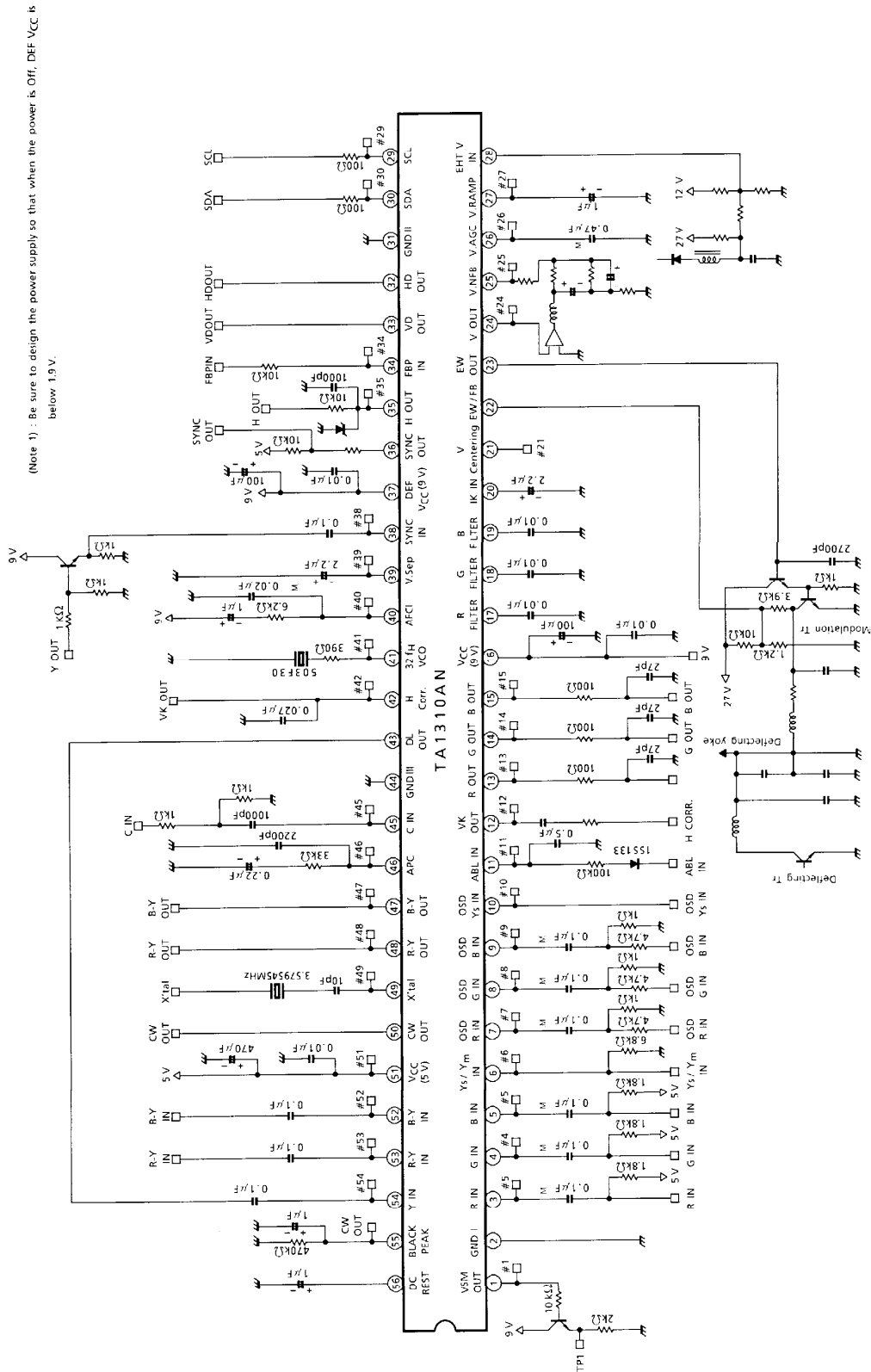

(Note 1) : Be sure to design the power supply so that when the power is Off, DEF VCC is below 1.9 V.

PACKAGE DIMENSIONS
SDIP56-P-600-1.78

Unit : mm

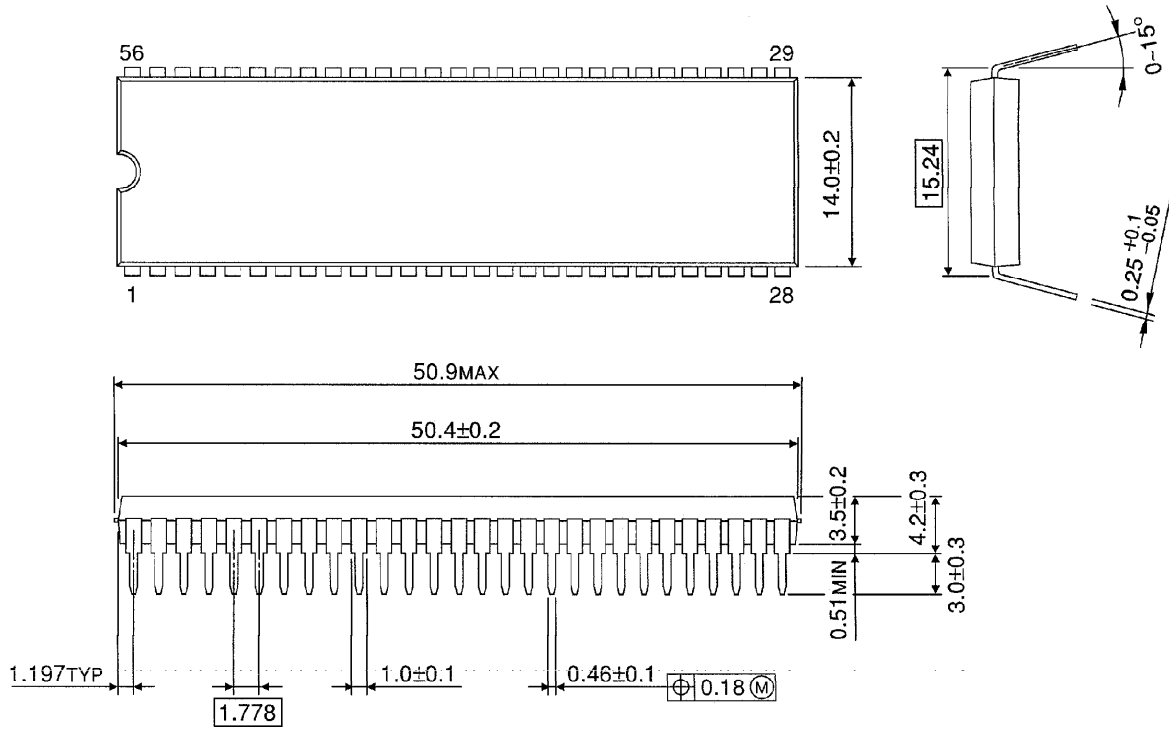

Weight : 5.55 g (Typ.)