



MMBTA44/45

NPN SILICON TRANSISTOR

HIGH VOLTAGE TRANSISTORS

FEATURES

- *Collector-Emitter voltage: $V_{CE0}=400V$ (UTC **MMBTA44**)
 $V_{CE0}=350V$ (UTC **MMBTA45**)
- *Collector current up to 300mA
- *Complement to UTC **MMBTA94/93**
- *Power Dissipation: $P_D(max)=350mW$

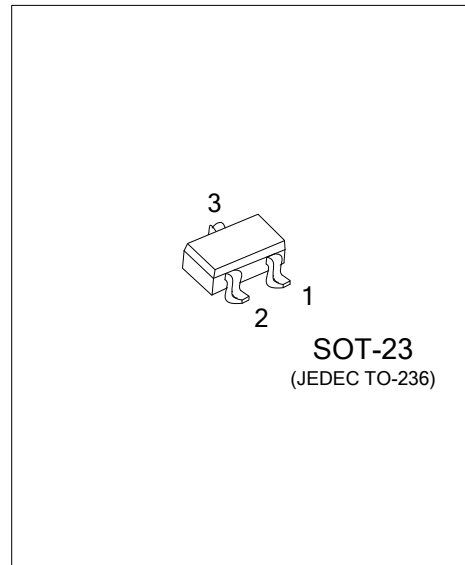

ORDERING INFORMATION

Ordering Number	Package	Pin Assignment			Packing
		1	2	3	
MMBTA44G-AE3-R	SOT-23	E	B	C	Tape Reel
MMBTA45G-AE3-R	SOT-23	E	B	C	Tape Reel

Note: Pin Assignment: E: Emitter B: Base C: Collector

<p>MMBTA44G-AE3-R</p> <p>(1) Packing Type</p> <p>(2) Package Type</p> <p>(3) Green Package</p>	<p>(1) R: Tape Reel</p> <p>(2) AE3: SOT-23</p> <p>(3) G: Halogen Free and Lead Free</p>
--	---

MARKINGS

MMBTA44	MMBTA45
<p>3DG</p>	<p>35G</p>

■ ABSOLUTE MAXIMUM RATINGS

PARAMETER		SYMBOL	RATINGS	UNIT
Collector-Base Voltage	MMBTA44	V_{CBO}	500	V
	MMBTA45		400	V
Collector-Emitter Voltage	MMBTA44	V_{CEO}	400	V
	MMBTA45		350	V
Emitter-Base Voltage		V_{EBO}	6	V
Collector Current		I_C	300	mA
Power Dissipation	$T_A=25^\circ\text{C}$	P_D	350	mW
	$T_C=25^\circ\text{C}$		1.5	W
Junction Temperature		T_J	+150	$^\circ\text{C}$
Storage Temperature		T_{STG}	-40 ~ +150	$^\circ\text{C}$

Note: Absolute maximum ratings are those values beyond which the device could be permanently damaged. Absolute maximum ratings are stress ratings only and functional device operation is not implied.

■ ELECTRICAL CHARACTERISTICS ($T_J=25^\circ\text{C}$, unless otherwise specified)

PARAMETER		SYMBOL	TEST CONDITIONS	MIN	TYP	MAX	UNIT
Collector-Base Breakdown Voltage	MMBTA44	BV_{CBO}	$I_C=100\mu\text{A}, I_B=0$	500			V
	MMBTA45			400			V
Collector-Emitter Breakdown Voltage	MMBTA44	BV_{CEO}	$I_C=1\text{mA}, I_B=0$	400			V
	MMBTA45			350			V
Emitter-Base Breakdown Voltage		BV_{EBO}	$I_E=100\mu\text{A}, I_C=0$	6			V
Collector-Emitter Saturation Voltage		$V_{CE(SAT)}$	$I_C=1\text{mA}, I_B=0.1\text{mA}$			0.4	V
			$I_C=10\text{mA}, I_B=1\text{mA}$			0.5	V
			$I_C=50\text{mA}, I_B=5\text{mA}$			0.75	V
Base-Emitter Saturation Voltage		$V_{BE(SAT)}$	$I_C=10\text{mA}, I_B=1\text{mA}$			0.75	V
Collector Cut-off Current	MMBTA44	I_{CBO}	$V_{CB}=400\text{V}, I_E=0$			0.1	μA
	MMBTA45		$V_{CB}=320\text{V}, I_E=0$			0.1	μA
Collector Cut-off Current	MMBTA44	I_{CES}	$V_{CE}=400\text{V}, I_B=0$			0.5	μA
	MMBTA45		$V_{CE}=320\text{V}, I_B=0$			0.5	μA
Emitter Cut-off Current		I_{EBO}	$V_{EB}=4\text{V}, I_C=0$			0.1	μA
DC Current Gain (Note)		h_{FE1}	$V_{CE}=10\text{V}, I_C=1\text{mA}$	40			
			$V_{CE}=10\text{V}, I_C=10\text{mA}$	50		240	
			$V_{CE}=10\text{V}, I_C=50\text{mA}$	45			
			$V_{CE}=10\text{V}, I_C=100\text{mA}$	40			
Current Gain Bandwidth Product		f_T	$V_{CE}=20\text{V}, I_C=10\text{mA}$ $f=100\text{MHz}$	50			MHz
Output Capacitance		C_{ob}	$V_{CB}=20\text{V}, I_E=0, f=1\text{MHz}$			7	pF

Note: Pulse test: $P_W < 300\mu\text{s}$, Duty Cycle $< 2\%$

TYPICAL CHARACTERISTICS

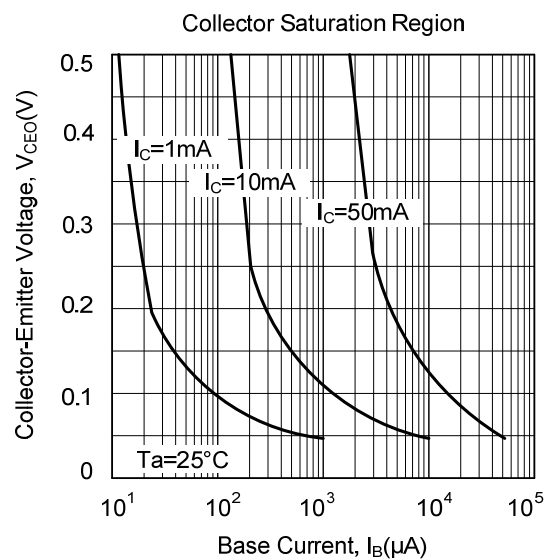
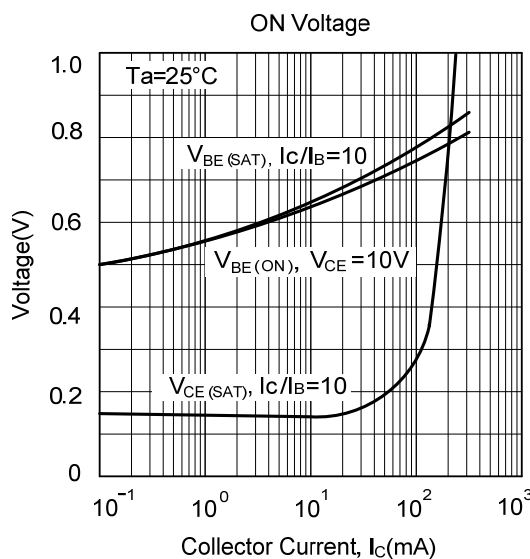
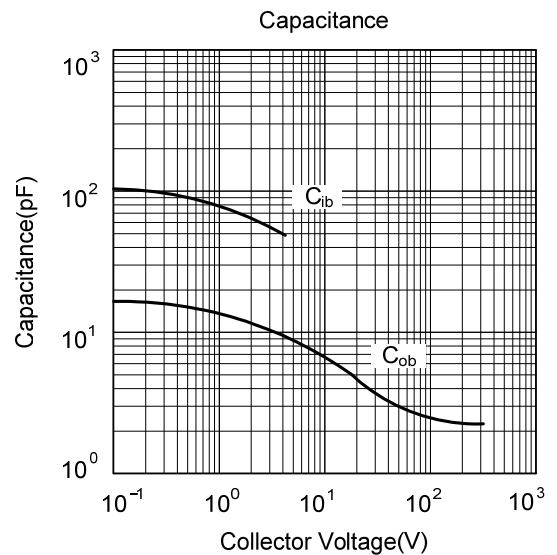
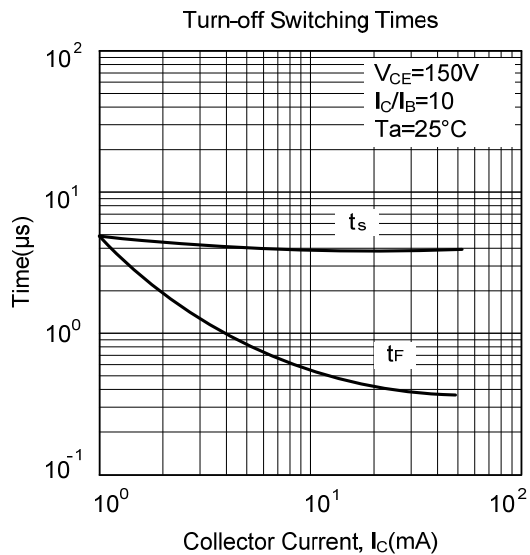
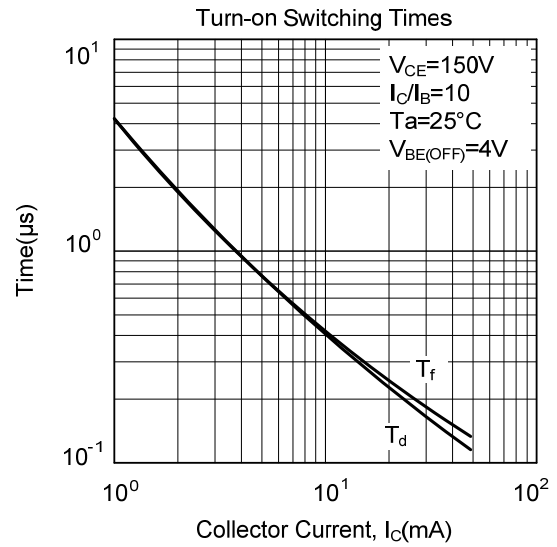
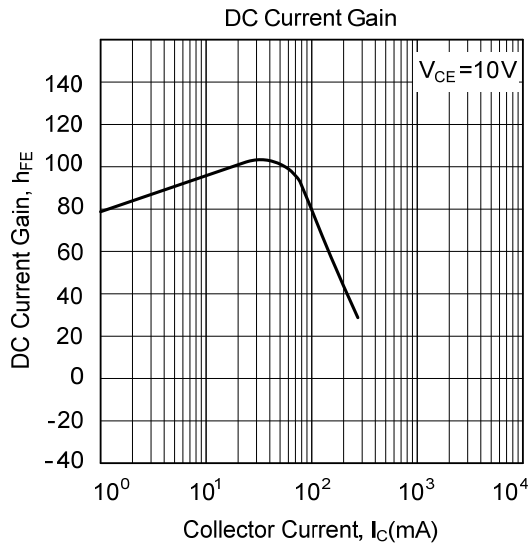

■ TYPICAL CHARACTERISTICS(cont.)

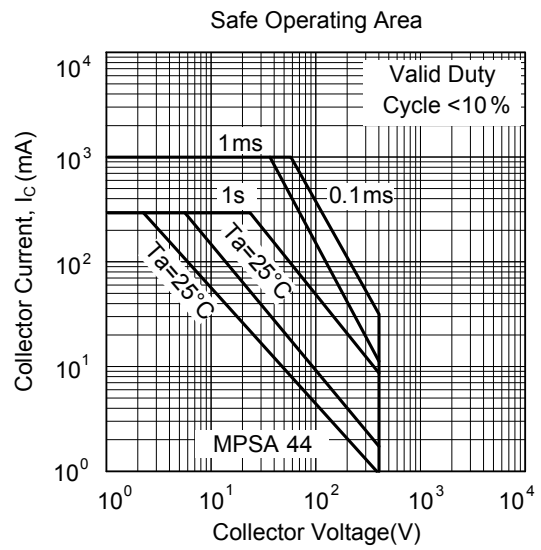
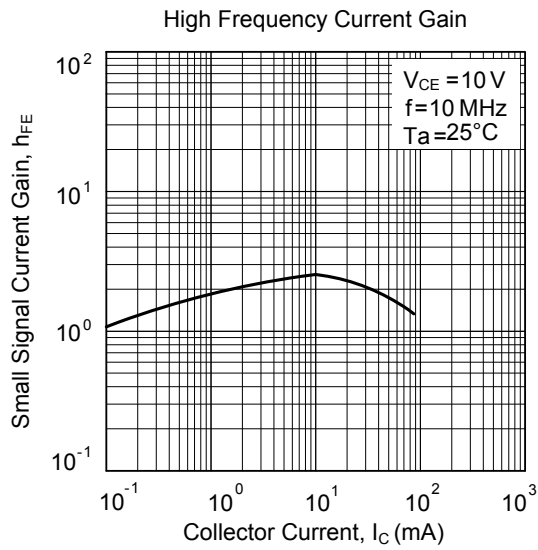

UTC assumes no responsibility for equipment failures that result from using products at values that exceed, even momentarily, rated values (such as maximum ratings, operating condition ranges, or other parameters) listed in products specifications of any and all UTC products described or contained herein. UTC products are not designed for use in life support appliances, devices or systems where malfunction of these products can be reasonably expected to result in personal injury. Reproduction in whole or in part is prohibited without the prior written consent of the copyright owner. The information presented in this document does not form part of any quotation or contract, is believed to be accurate and reliable and may be changed without notice.