

**P-Channel Enhancement Mode MOSFET**

# MTP3415KN3

BV <sub>DSS</sub>		-20V
I <sub>D</sub>		-4.4A
R <sub>DSON(TYP)</sub>	V <sub>GS</sub> =-4.5V, I <sub>D</sub> =-4A	33mΩ
	V <sub>GS</sub> =-2.5V, I <sub>D</sub> =-4A	42mΩ
	V <sub>GS</sub> =-1.8V, I <sub>D</sub> =-2A	52mΩ

**Features**

- ESD protected 3KV
- Advanced trench process technology
- High density cell design for ultra low on resistance
- Pb-free lead plating and halogen-free package

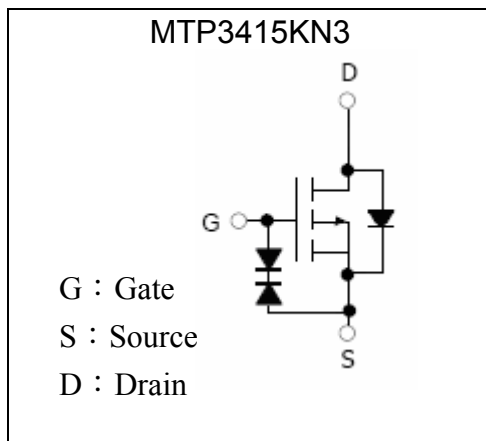
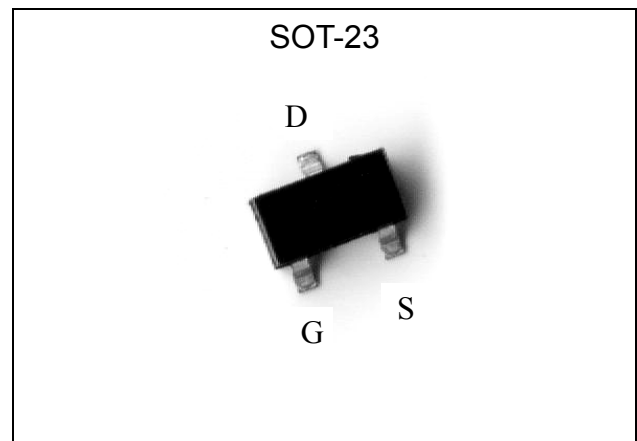
**Equivalent Circuit**

**Outline**

**Absolute Maximum Ratings (T<sub>a</sub>=25°C)**

Parameter		Symbol	Limits	Unit
Drain-Source Voltage		V <sub>DS</sub>	-20	V
Gate-Source Voltage		V <sub>GS</sub>	±12	
Continuous Drain Current	T <sub>A</sub> =25°C	I <sub>D</sub>	-4.4	A
	T <sub>A</sub> =70°C	I <sub>D</sub>	-3.5	
Pulsed Drain Current (Note 1&2)		I <sub>DM</sub>	-30	
Maximum Power Dissipation	T <sub>A</sub> =25°C	P <sub>D</sub>	1.4	W
	T <sub>A</sub> =70°C		0.9	
ESD susceptibility (Note 3)			3000	V
Operating Junction and Storage Temperature		T <sub>j</sub> , T <sub>stg</sub>	-55~+150	°C

- Note : 1. Pulse width limited by maximum junction temperature.  
 2. Pulse width ≤ 300μs, duty cycle ≤ 2%  
 3. Human body model, 1.5kΩ in series with 100pF.



**Thermal Performance**

Parameter	Symbol	Limit	Unit
Thermal Resistance, Junction-to-Ambient (Note)	R <sub>θJA</sub>	90	°C/W
Thermal Resistance, Junction-to-Case	R <sub>θJC</sub>	70	°C/W

Note : Surface mounted on 1 in<sup>2</sup> copper pad of FR-4 board, t<sub>s</sub>≤10s; 125°C/W at steady state; 417°C/W when mounted on minimum copper pad.

**Electrical Characteristics (T<sub>j</sub>=25°C, unless otherwise specified)**

Symbol	Min.	Typ.	Max.	Unit	Test Conditions
<b>Static</b>					
BV <sub>DSS</sub>	-20	-	-	V	V <sub>GS</sub> =0, I <sub>D</sub> =-250μA
V <sub>GS(th)</sub>	-0.4	-0.6	-1.0		V <sub>DS</sub> =V <sub>GS</sub> , I <sub>D</sub> =-250μA
I <sub>GSS</sub>	-	-	±10	μA	V <sub>GS</sub> =±10V, V <sub>DS</sub> =0
I <sub>DSS</sub>	-	-	-1		V <sub>DS</sub> =-20V, V <sub>GS</sub> =0
	-	-	-10		V <sub>DS</sub> =-20V, V <sub>GS</sub> =0, T <sub>j</sub> =55°C
*R <sub>DS(ON)</sub>	-	33	43	mΩ	V <sub>GS</sub> =-4.5V, I <sub>D</sub> =-4.0A
	-	42	54		V <sub>GS</sub> =-2.5V, I <sub>D</sub> =-4.0A
	-	52	73		V <sub>GS</sub> =-1.8V, I <sub>D</sub> =-2.0A
*G <sub>FS</sub>	-	11	-	S	V <sub>DS</sub> =-5V, I <sub>D</sub> =-4.0A
<b>Dynamic</b>					
C <sub>iss</sub>	-	651	-	pF	V <sub>DS</sub> =-10V, V <sub>GS</sub> =0, f=1MHz
C <sub>oss</sub>	-	104	-		
C <sub>rss</sub>	-	36	-		
*t <sub>d(ON)</sub>	-	7	-	ns	V <sub>DS</sub> =-10V, I <sub>D</sub> =-4A, V <sub>GS</sub> =-4.5V, R <sub>G</sub> =3Ω
*t <sub>r</sub>	-	13	-		
*t <sub>d(OFF)</sub>	-	84	-		
*t <sub>f</sub>	-	24	-		
*Q <sub>g</sub>	-	8	-	nC	V <sub>DS</sub> =-10V, I <sub>D</sub> =-4A, V <sub>GS</sub> =-4.5V
*Q <sub>gs</sub>	-	1.4	-		
*Q <sub>gd</sub>	-	2.2	-		
<b>Source-Drain Diode</b>					
*V <sub>SD</sub>	-	-0.76	-1	V	V <sub>GS</sub> =0V, I <sub>S</sub> =-1A
*I <sub>SD</sub>	-	-	-4	A	
*t <sub>rr</sub>	-	25	-	ns	I <sub>S</sub> =-4A, V <sub>GS</sub> =0V, dI/dt=100A/μs
*Q <sub>rr</sub>	-	12	-	nC	

\*Pulse Test : Pulse Width ≤300μs, Duty Cycle≤2%

**Ordering Information**

Device	Package	Shipping
MTP3415KN3-0-T1-G	SOT-23 (Pb-free lead plating and halogen-free package)	3000 pcs / Tape & Reel

**Typical Characteristics**

Typical Output Characteristics

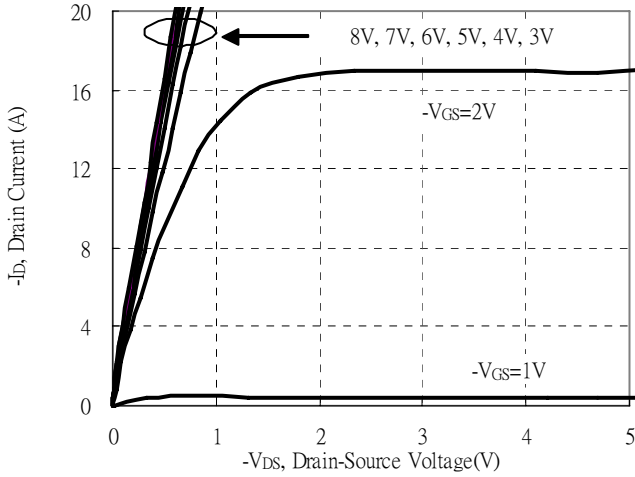

Breakdown Voltage vs Ambient Temperature

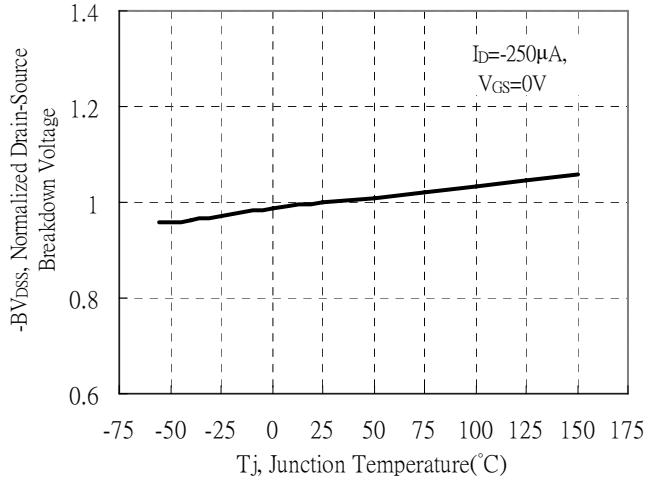

Static Drain-Source On-State resistance vs Drain Current

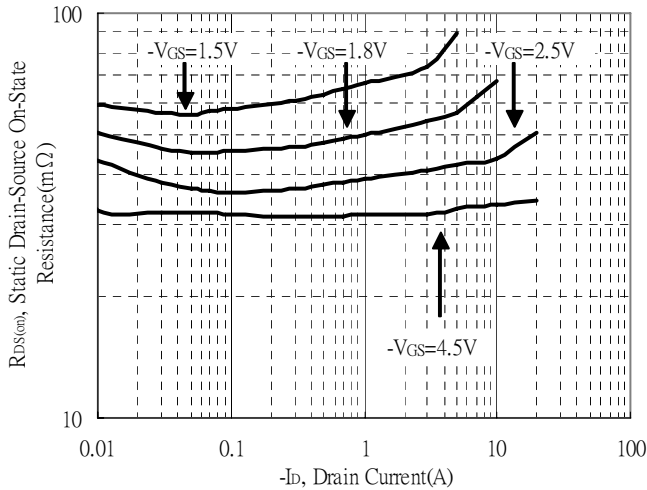

Reverse Drain Current vs Source-Drain Voltage

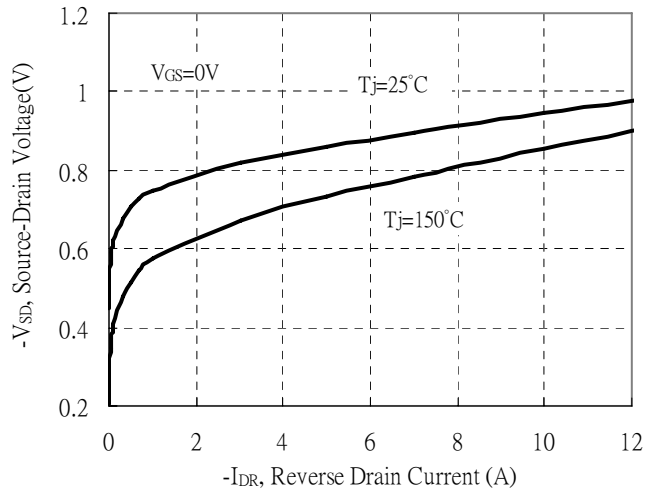

Static Drain-Source On-State Resistance vs Gate-Source Voltage

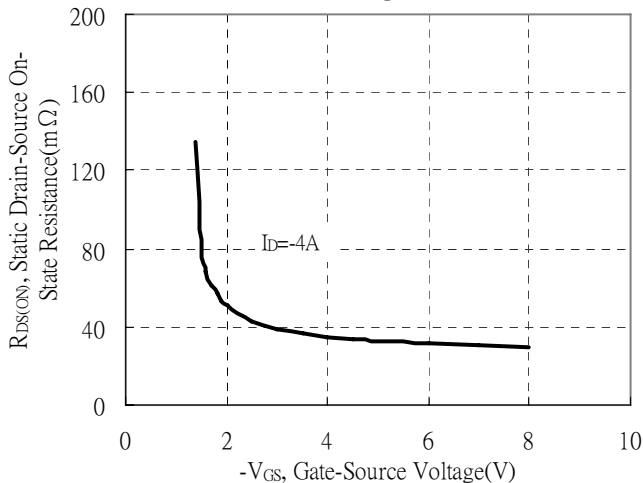

Drain-Source On-State Resistance vs Junction Temperature

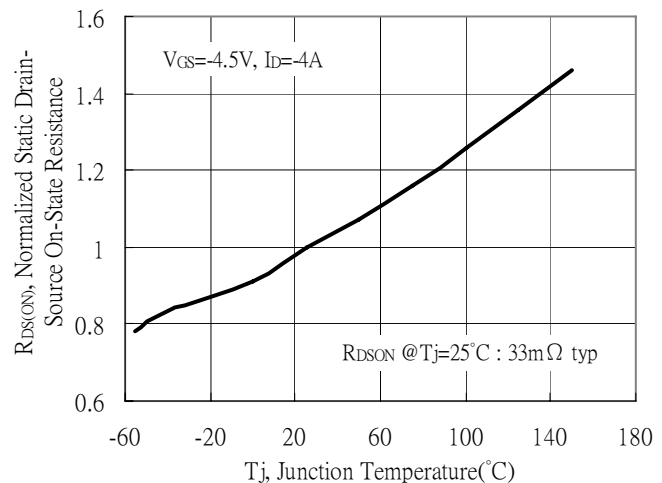



**Typical Characteristics(Cont.)**

Capacitance vs Drain-to-Source Voltage

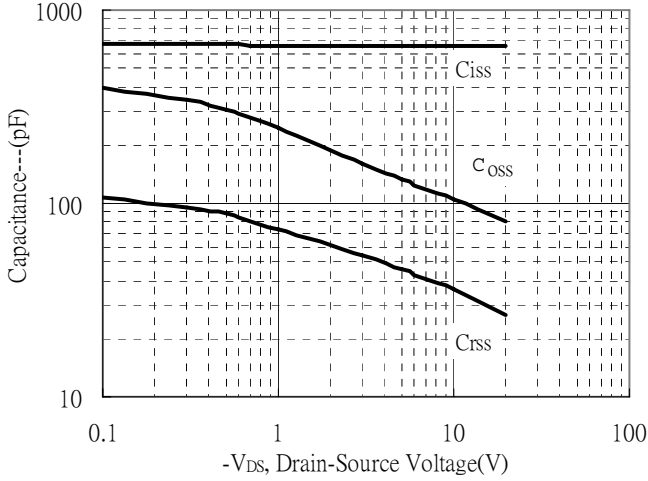

Threshold Voltage vs Junction Temperature

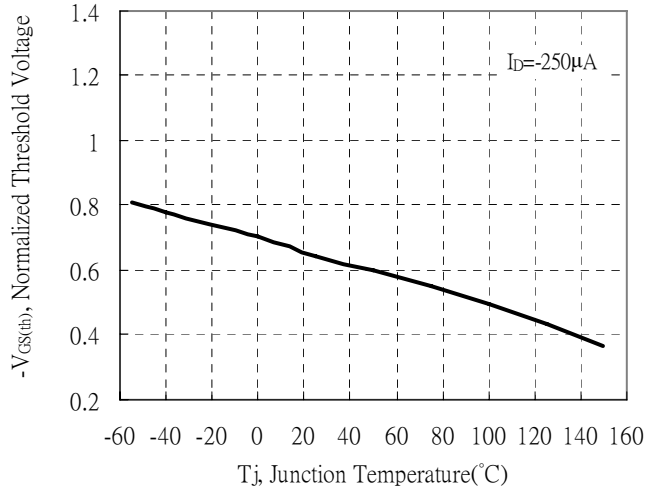

Forward Transfer Admittance vs Drain Current

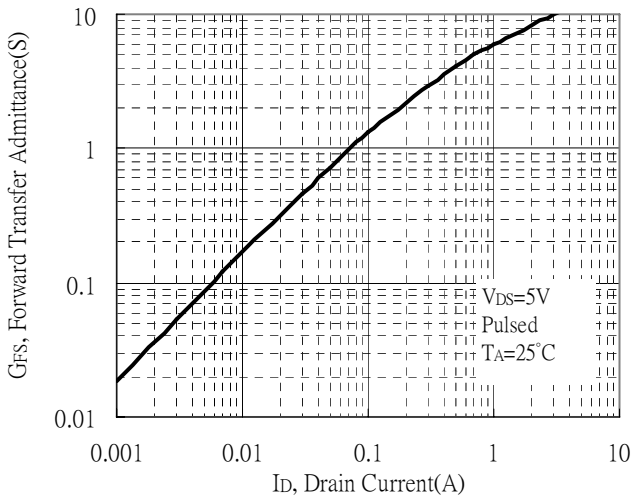

Gate Charge Characteristics

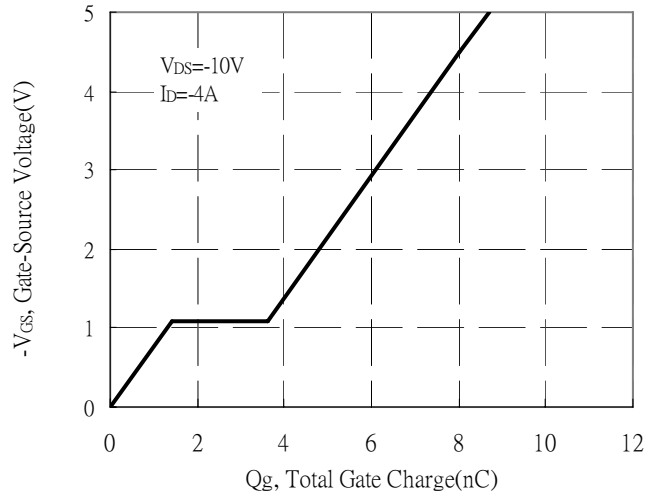

Maximum Safe Operating Area

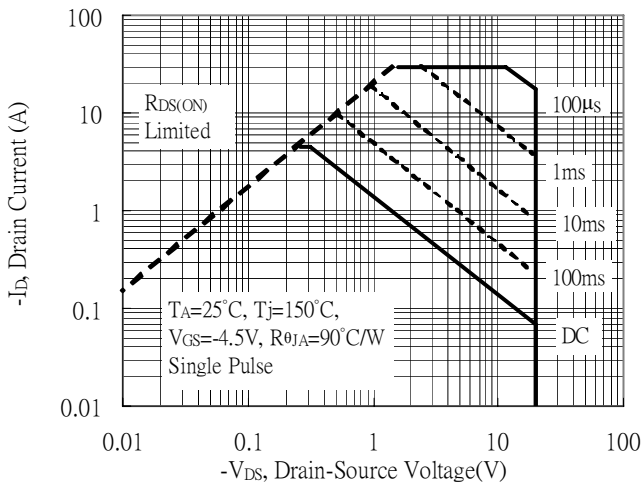

Maximum Drain Current vs Junction Temperature

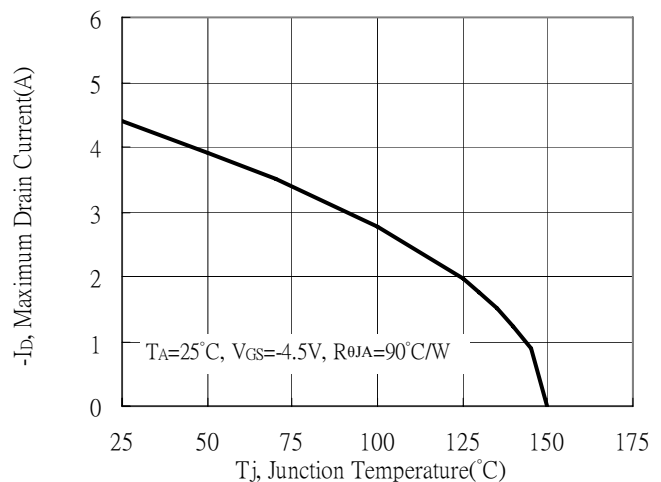

**Typical Characteristics(Cont.)**

Typical Transfer Characteristics

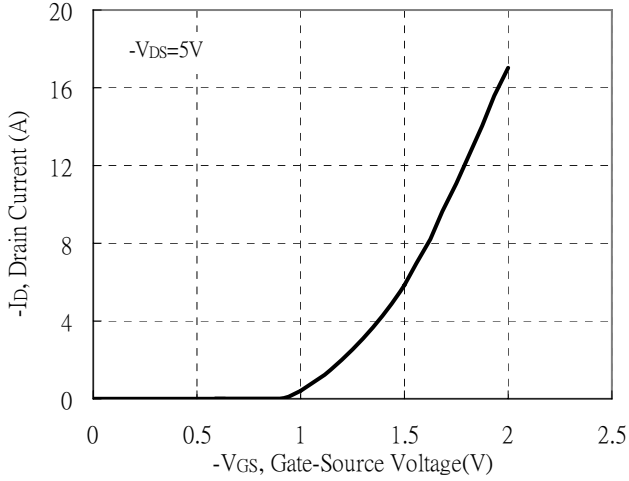

Single Pulse Power Rating, Junction to Ambient  
 (Note on page 2)

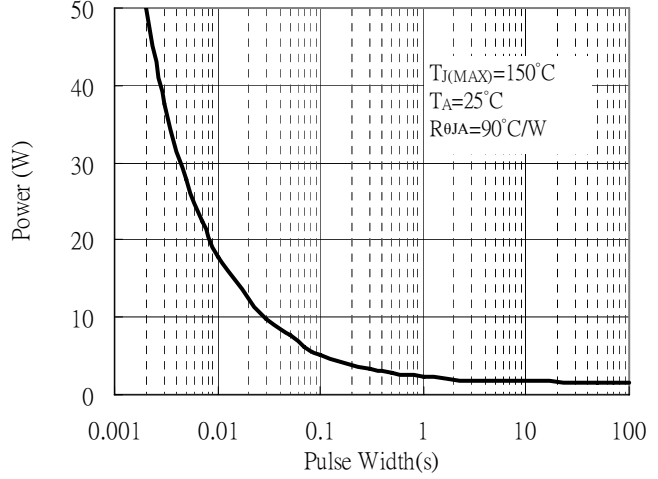

Transient Thermal Response Curves

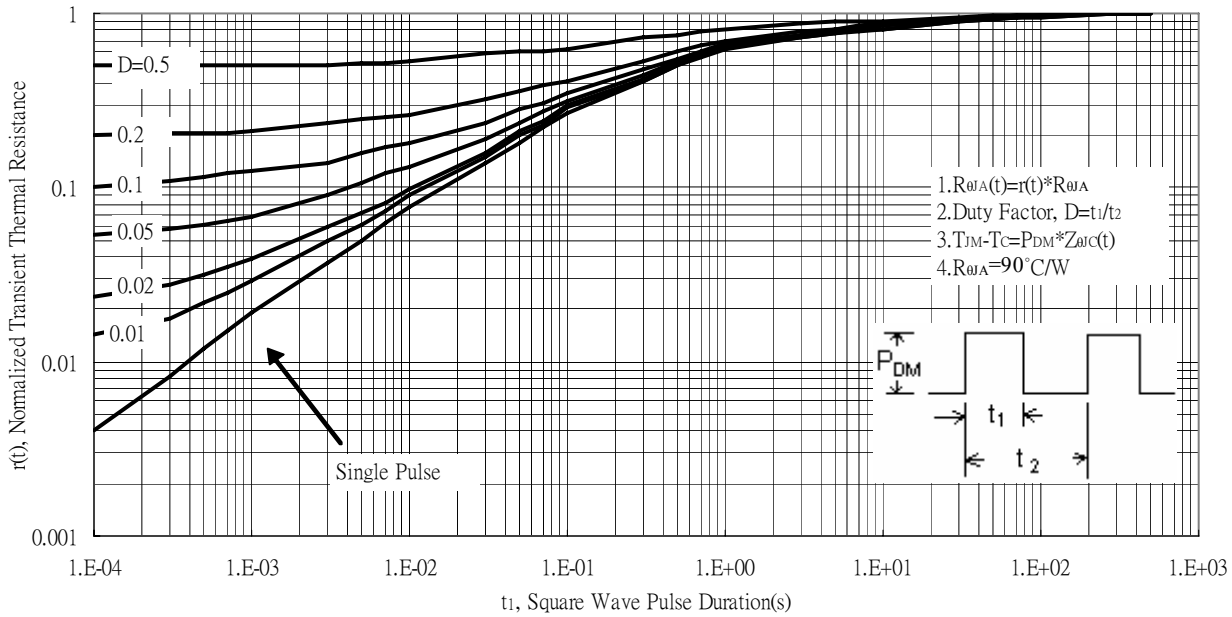

### Recommended Soldering Footprint

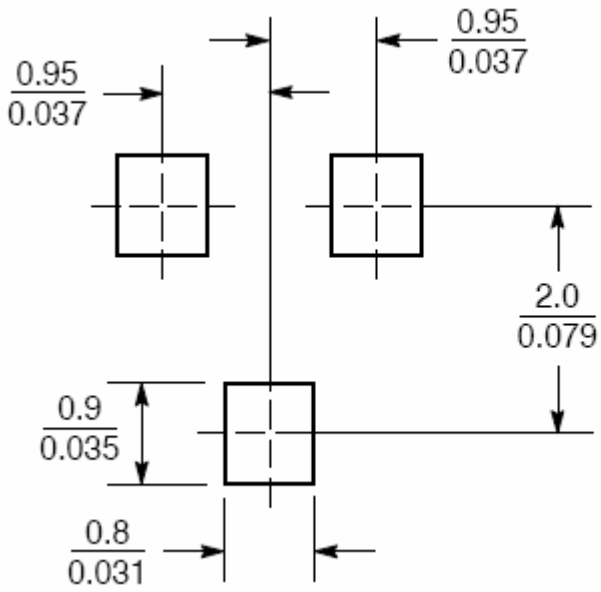

Unit :  $\frac{\text{mm}}{\text{inches}}$

**Reel Dimension**

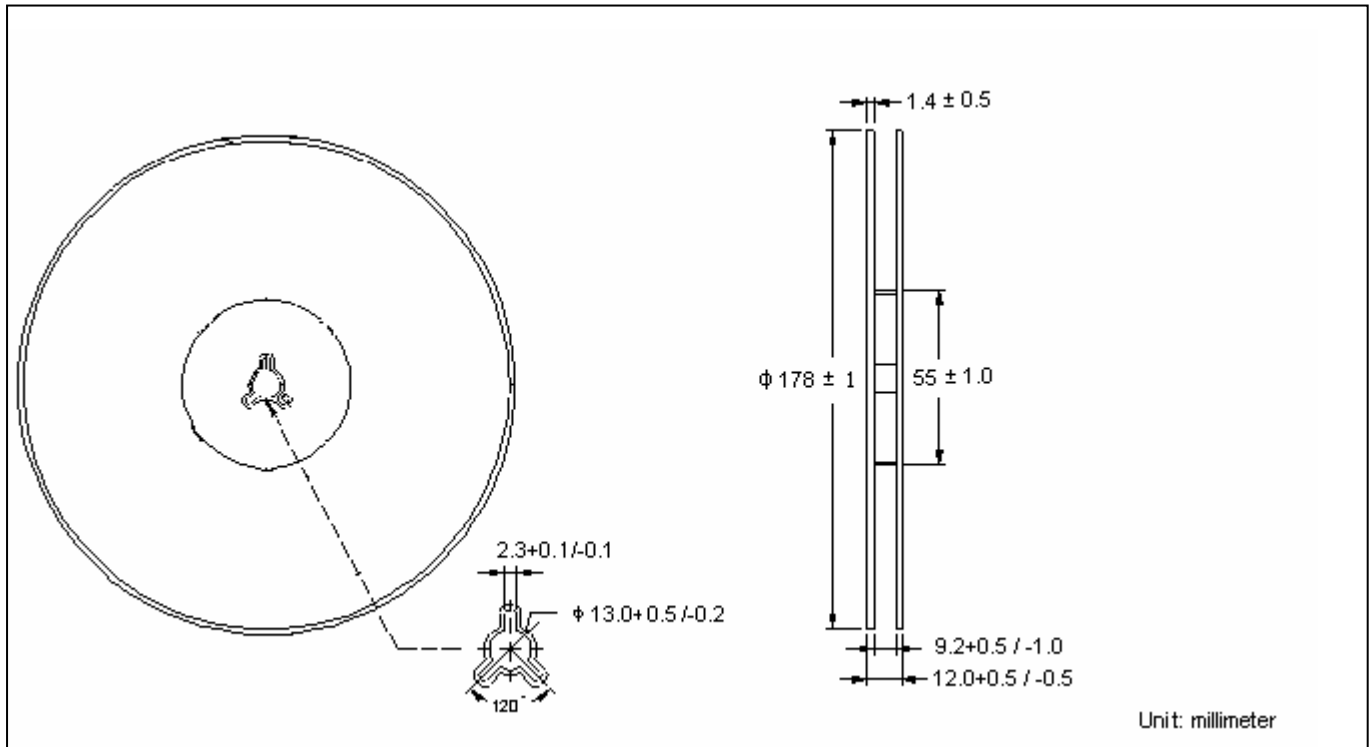

**Carrier Tape Dimension**

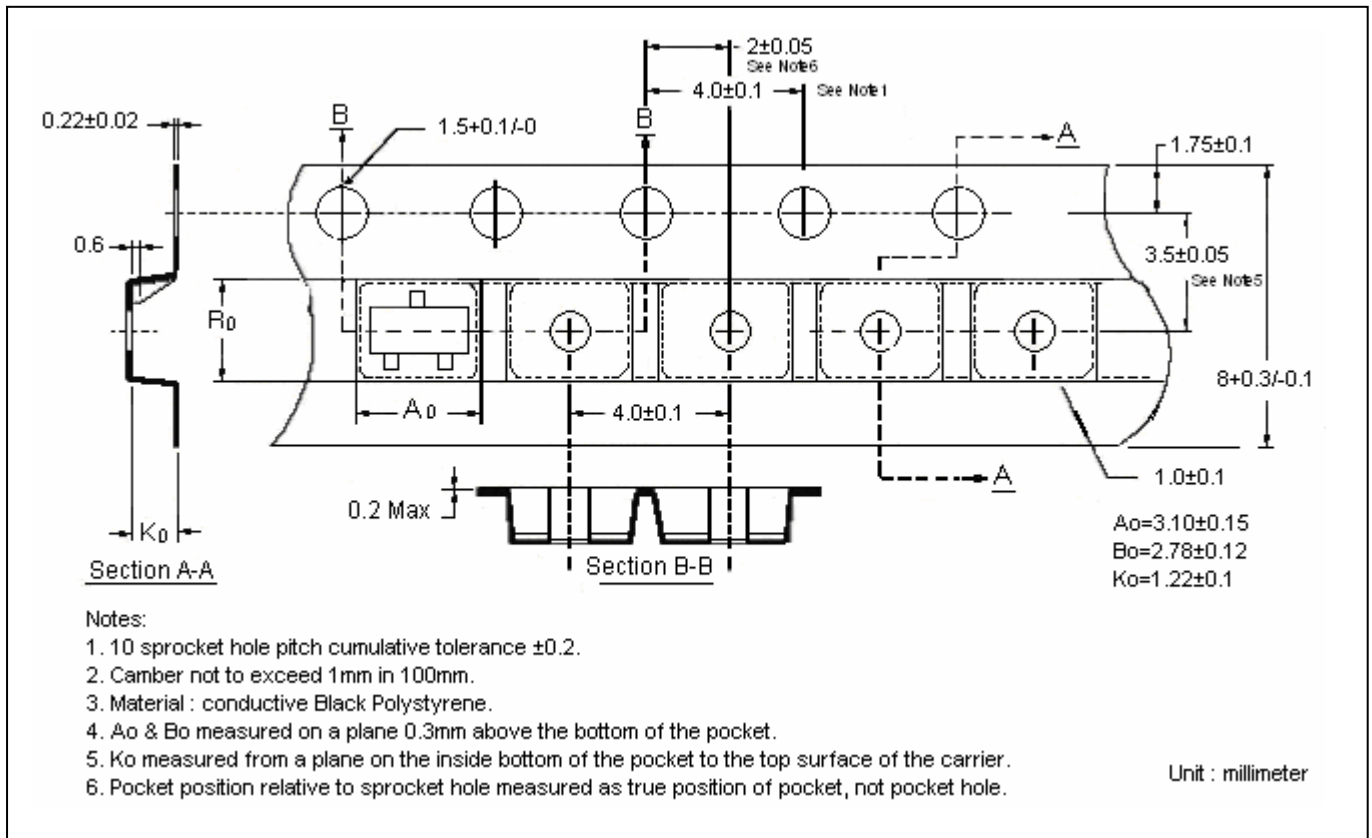

**Recommended wave soldering condition**

Product	Peak Temperature	Soldering Time
Pb-free devices	260 +0/-5 °C	5 +1/-1 seconds

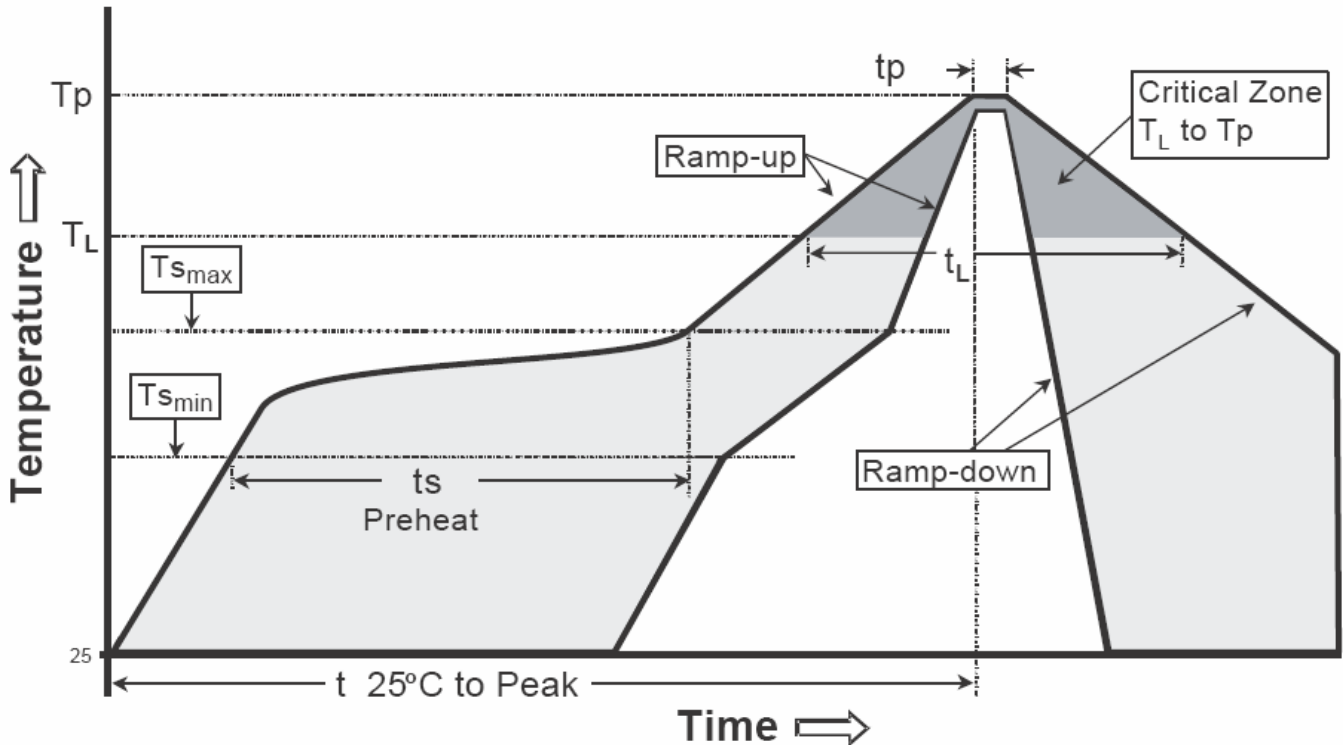
**Recommended temperature profile for IR reflow**

Profile feature	Sn-Pb eutectic Assembly	Pb-free Assembly
Average ramp-up rate (Tsmax to Tp)	3°C/second max.	3°C/second max.
Preheat		
-Temperature Min(Ts min)	100°C	150°C
-Temperature Max(Ts max)	150°C	200°C
-Time(ts min to ts max)	60-120 seconds	60-180 seconds
Time maintained above:		
-Temperature (TL)	183°C	217°C
- Time (tL)	60-150 seconds	60-150 seconds
Peak Temperature(TP)	240 +0/-5 °C	260 +0/-5 °C
Time within 5°C of actual peak temperature(tp)	10-30 seconds	20-40 seconds
Ramp down rate	6°C/second max.	6°C/second max.
Time 25 °C to peak temperature	6 minutes max.	8 minutes max.

Note : All temperatures refer to topside of the package, measured on the package body surface.



**SOT-23 Dimension**

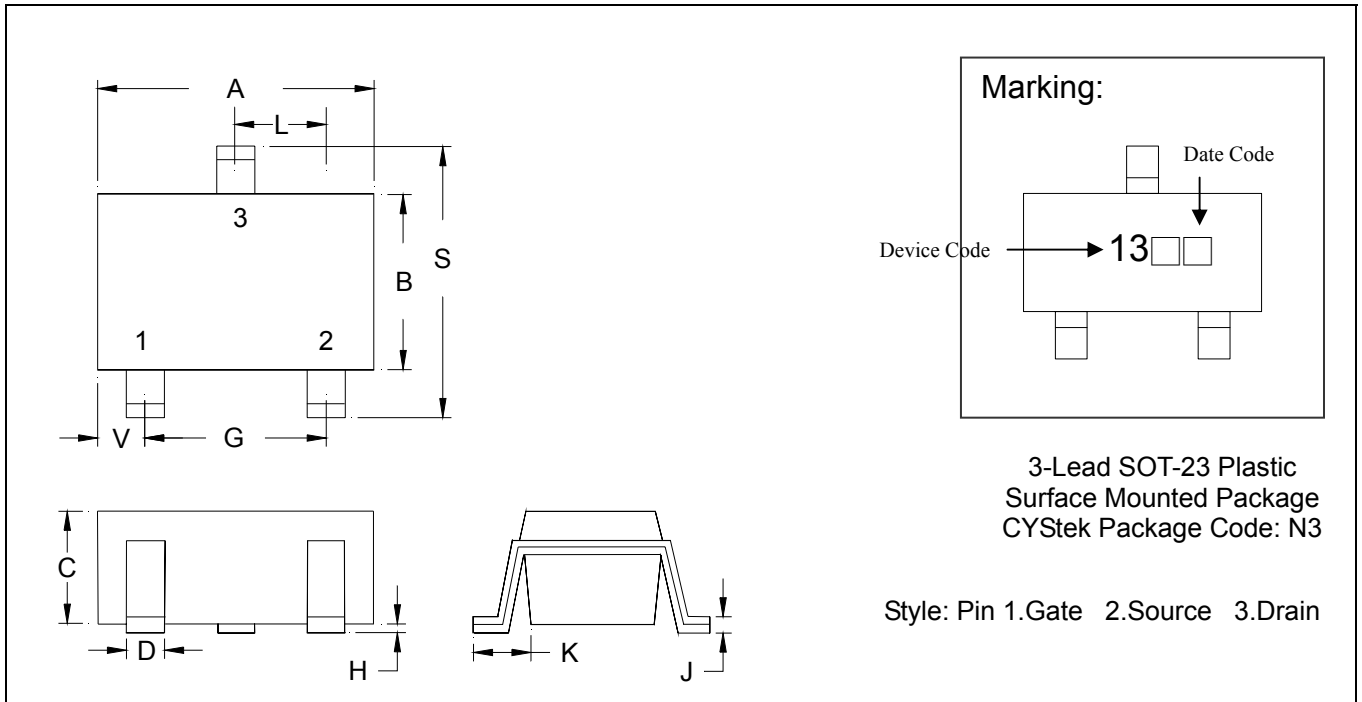

DIM	Inches		Millimeters		DIM	Inches		Millimeters	
	Min.	Max.	Min.	Max.		Min.	Max.	Min.	Max.
A	0.1102	0.1204	2.80	3.04	J	0.0032	0.0079	0.08	0.20
B	0.0472	0.0669	1.20	1.70	K	0.0118	0.0266	0.30	0.67
C	0.0335	0.0512	0.89	1.30	L	0.0335	0.0453	0.85	1.15
D	0.0118	0.0197	0.30	0.50	S	0.0830	0.1161	2.10	2.95
G	0.0669	0.0910	1.70	2.30	V	0.0098	0.0256	0.25	0.65
H	0.0000	0.0040	0.00	0.10					

**Notes:** 1.Controlling dimension: millimeters.  
 2.Maximum lead thickness includes lead finish thickness, and minimum lead thickness is the minimum thickness of base material.  
 3.If there is any question with packing specification or packing method, please contact your local CYStek sales office.

**Material:**

- Lead: Pure tin plated.
- Mold Compound: Epoxy resin family, flammability solid burning class: UL94V-0

**Important Notice:**

- All rights are reserved. Reproduction in whole or in part is prohibited without the prior written approval of CYStek.
- CYStek reserves the right to make changes to its products without notice.
- CYStek **semiconductor products are not warranted to be suitable for use in Life-Support Applications, or systems.**
- CYStek assumes no liability for any consequence of customer product design, infringement of patents, or application assistance.