

## Cool MOS™ Power Transistor

### Feature

- New revolutionary high voltage technology
- Worldwide best  $R_{DS(on)}$  in TO 220
- Ultra low gate charge
- Periodic avalanche rated
- Extreme  $dv/dt$  rated
- Ultra low effective capacitances
- Improved transconductance
- PG-TO-220-3-31: Fully isolated package (2500 VAC; 1 minute)
- Pb-free lead plating; RoHS compliant
- Qualified according to JEDEC<sup>0)</sup> for target applications

$V_{DS}$	800	V
$R_{DS(on)}$	0.29	$\Omega$
$I_D$	17	A

PG-TO220-3-31 PG-TO220

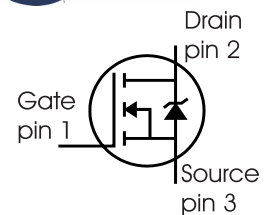
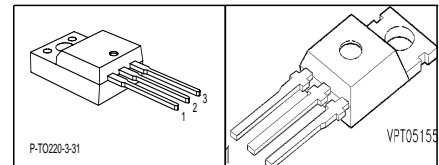

Type	Package	Ordering Code	Marking
SPP17N80C3	PG-TO220	Q67040-S4353	17N80C3
SPA17N80C3	PG-TO220-3-31	SP000216353	17N80C3

### Maximum Ratings

Parameter	Symbol	Value		Unit
		SPP	SPA	
Continuous drain current $T_C = 25\text{ }^\circ\text{C}$ $T_C = 100\text{ }^\circ\text{C}$	$I_D$	17 11	17 <sup>1)</sup> 11 <sup>1)</sup>	A
Pulsed drain current, $t_p$ limited by $T_{jmax}$	$I_{D\text{ puls}}$	51	51	A
Avalanche energy, single pulse $I_D=3.4\text{A}$ , $V_{DD}=50\text{V}$	$E_{AS}$	670	670	mJ
Avalanche energy, repetitive $t_{AR}$ limited by $T_{jmax}$ <sup>2)</sup> $I_D=17\text{A}$ , $V_{DD}=50\text{V}$	$E_{AR}$	0.5	0.5	
Avalanche current, repetitive $t_{AR}$ limited by $T_{jmax}$	$I_{AR}$	17	17	A
Gate source voltage	$V_{GS}$	$\pm 20$	$\pm 20$	V
Gate source voltage AC ( $f > 1\text{Hz}$ )	$V_{GS}$	$\pm 30$	$\pm 30$	
Power dissipation, $T_C = 25\text{ }^\circ\text{C}$	$P_{tot}$	208	42	W
Operating and storage temperature	$T_j, T_{stg}$	-55...+150		$^\circ\text{C}$

**Maximum Ratings**

Parameter	Symbol	Value	Unit
Drain Source voltage slope $V_{DS} = 640 \text{ V}$ , $I_D = 17 \text{ A}$ , $T_j = 125 \text{ }^\circ\text{C}$	$dv/dt$	50	V/ns

**Thermal Characteristics**

Parameter	Symbol	Values			Unit
		min.	typ.	max.	
Thermal resistance, junction - case	$R_{thJC}$	-	-	0.6	K/W
Thermal resistance, junction - case, FullPAK	$R_{thJC \text{ FP}}$	-	-	3.6	
Thermal resistance, junction - ambient, leaded	$R_{thJA}$	-	-	62	
Thermal resistance, junction - ambient, FullPAK	$R_{thJA \text{ FP}}$	-	-	80	
SMD version, device on PCB: @ min. footprint @ 6 cm <sup>2</sup> cooling area <sup>3)</sup>	$R_{thJA}$	-	-	62	
Soldering temperature, wavesoldering 1.6 mm (0.063 in.) from case for 10s <sup>4)</sup>	$T_{sold}$	-	-	260	°C

**Electrical Characteristics, at  $T_j=25^\circ\text{C}$  unless otherwise specified**

Parameter	Symbol	Conditions	Values			Unit
			min.	typ.	max.	
Drain-source breakdown voltage	$V_{(BR)DSS}$	$V_{GS}=0\text{V}$ , $I_D=0.25\text{mA}$	800	-	-	V
Drain-Source avalanche breakdown voltage	$V_{(BR)DS}$	$V_{GS}=0\text{V}$ , $I_D=17\text{A}$	-	870	-	
Gate threshold voltage	$V_{GS(th)}$	$I_D=1000\mu\text{A}$ , $V_{GS}=V_D$	2.1	3	3.9	
Zero gate voltage drain current	$I_{DSS}$	$V_{DS}=800\text{V}$ , $V_{GS}=0\text{V}$ , $T_j=25^\circ\text{C}$ $T_j=150^\circ\text{C}$	-	0.5	25	$\mu\text{A}$
Gate-source leakage current	$I_{GSS}$	$V_{GS}=20\text{V}$ , $V_{DS}=0\text{V}$	-	-	100	
Drain-source on-state resistance	$R_{DS(on)}$	$V_{GS}=10\text{V}$ , $I_D=11\text{A}$ $T_j=25^\circ\text{C}$ $T_j=150^\circ\text{C}$	-	0.25	0.29	$\Omega$
Gate input resistance	$R_G$	$f=1\text{MHz}$ , open drain	-	0.7	-	

### Electrical Characteristics

Parameter	Symbol	Conditions	Values			Unit
			min.	typ.	max.	
Transconductance	$g_{fs}$	$V_{DS} \geq 2 \cdot I_D \cdot R_{DS(on)max}$ , $I_D = 11A$	-	15	-	S
Input capacitance	$C_{iss}$	$V_{GS} = 0V$ , $V_{DS} = 25V$ , $f = 1MHz$	-	2320	-	pF
Output capacitance	$C_{oss}$		-	1250	-	
Reverse transfer capacitance	$C_{rss}$		-	60	-	
Effective output capacitance, <sup>5)</sup> energy related	$C_{o(er)}$	$V_{GS} = 0V$ , $V_{DS} = 0V$ to 480V	-	59	-	
Effective output capacitance, <sup>6)</sup> time related	$C_{o(tr)}$		-	124	-	
Turn-on delay time	$t_{d(on)}$	$V_{DD} = 400V$ , $V_{GS} = 0/10V$ , $I_D = 17A$ , $R_G = 4.7\Omega$ , $T_j = 125^\circ C$	-	25	-	ns
Rise time	$t_r$		-	15	-	
Turn-off delay time	$t_{d(off)}$		-	72	82	
Fall time	$t_f$		-	6	9	

### Gate Charge Characteristics

Gate to source charge	$Q_{gs}$	$V_{DD} = 640V$ , $I_D = 17A$	-	12	-	nC
Gate to drain charge	$Q_{gd}$		-	46	-	
Gate charge total	$Q_g$	$V_{DD} = 640V$ , $I_D = 17A$ , $V_{GS} = 0$ to 10V	-	91	177	
Gate plateau voltage	$V_{(plateau)}$	$V_{DD} = 640V$ , $I_D = 17A$	-	6	-	V

<sup>0</sup>J-STD20 and JESD22

<sup>1</sup>Limited only by maximum temperature

<sup>2</sup>Repetitive avalanche causes additional power losses that can be calculated as  $P_{AV} = E_{AR} \cdot f$ .

<sup>3</sup>Device on 40mm\*40mm\*1.5mm epoxy PCB FR4 with 6cm<sup>2</sup> (one layer, 70 μm thick) copper area for drain connection. PCB is vertical without blown air.

<sup>4</sup>Soldering temperature for TO-263: 220°C, reflow

<sup>5</sup> $C_{o(er)}$  is a fixed capacitance that gives the same stored energy as  $C_{oss}$  while  $V_{DS}$  is rising from 0 to 80%  $V_{DSS}$ .

<sup>6</sup> $C_{o(tr)}$  is a fixed capacitance that gives the same charging time as  $C_{oss}$  while  $V_{DS}$  is rising from 0 to 80%  $V_{DSS}$ .

**Electrical Characteristics**

Parameter	Symbol	Conditions	Values			Unit
			min.	typ.	max.	
Inverse diode continuous forward current	$I_S$	$T_C=25^\circ C$	-	-	17	A
Inverse diode direct current, pulsed	$I_{SM}$		-	-	51	
Inverse diode forward voltage	$V_{SD}$	$V_{GS}=0V, I_F=I_S$	-	1	1.2	V
Reverse recovery time	$t_{rr}$	$V_R=400V, I_F=I_S,$	-	550	-	ns
Reverse recovery charge	$Q_{rr}$	$di_F/dt=100A/\mu s$	-	15	-	$\mu C$
Peak reverse recovery current	$I_{rrm}$		-	51	-	A
Peak rate of fall of reverse recovery current	$di_{rr}/dt$	$T_j=25^\circ C$	-	1200	-	A/ $\mu s$

**Typical Transient Thermal Characteristics**

Symbol	Value		Unit	Symbol	Value		Unit
	SPP	SPA			SPP	SPA	
$R_{th1}$	0.00812	0.00812	K/W	$C_{th1}$	0.0003562	0.0003562	Ws/K
$R_{th2}$	0.016	0.016		$C_{th2}$	0.001337	0.001337	
$R_{th3}$	0.031	0.031		$C_{th3}$	0.001831	0.001831	
$R_{th4}$	0.114	0.16		$C_{th4}$	0.005033	0.005033	
$R_{th5}$	0.135	0.324		$C_{th5}$	0.012	0.008657	
$R_{th6}$	0.059	2.522		$C_{th6}$	0.092	0.412	

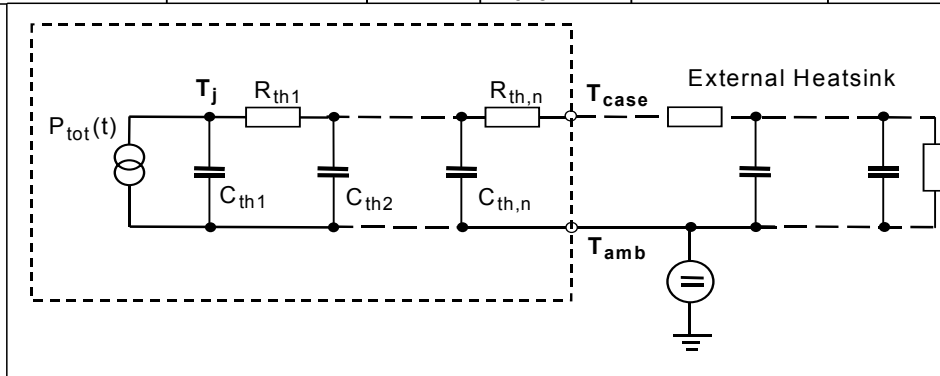

### 1 Power dissipation

$$P_{tot} = f(T_C)$$

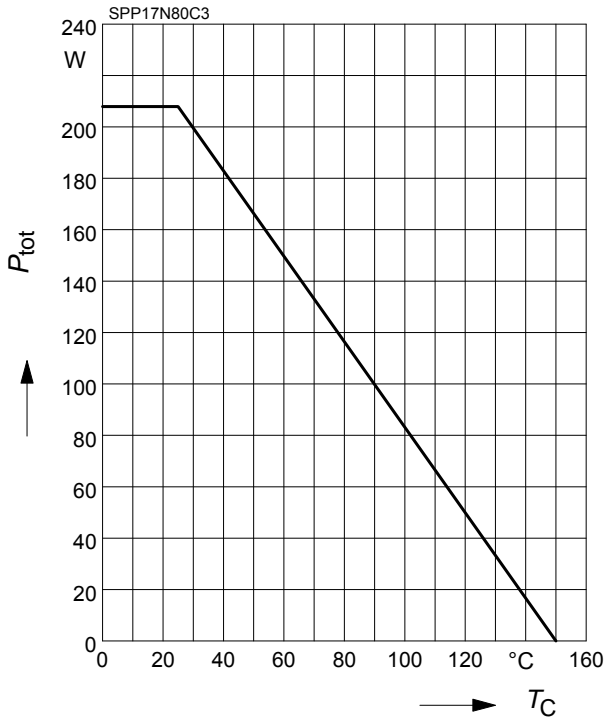

### 2 Power dissipation FullPAK

$$P_{tot} = f(T_C)$$

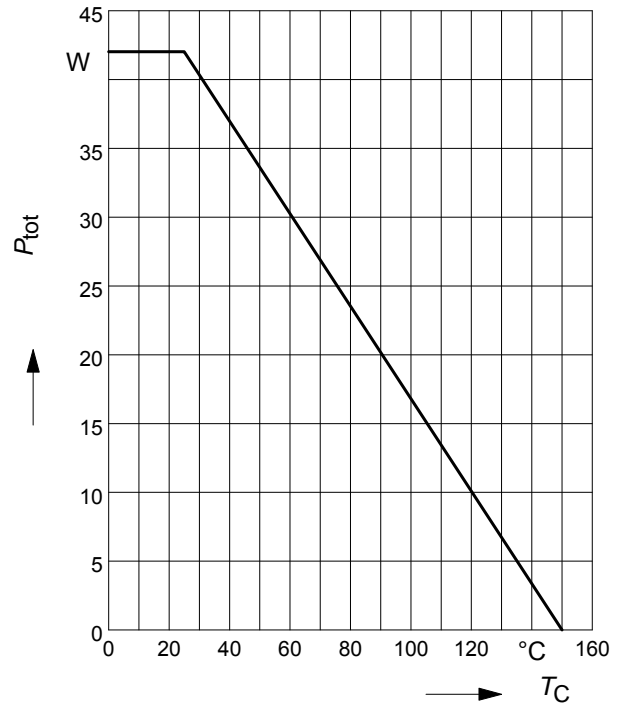

### 3 Safe operating area

$$I_D = f(V_{DS})$$

parameter :  $D = 0$  ,  $T_C = 25^\circ\text{C}$

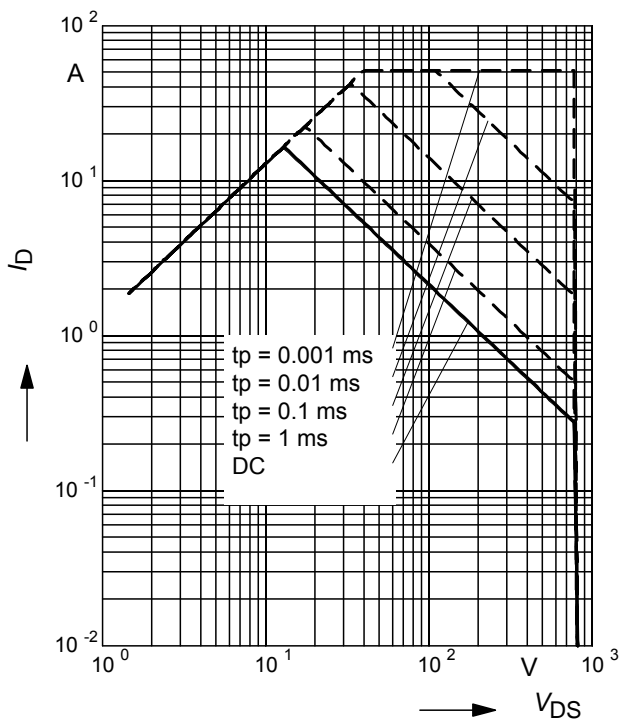

### 4 Safe operating area FullPAK

$$I_D = f(V_{DS})$$

parameter:  $D = 0$  ,  $T_C = 25^\circ\text{C}$

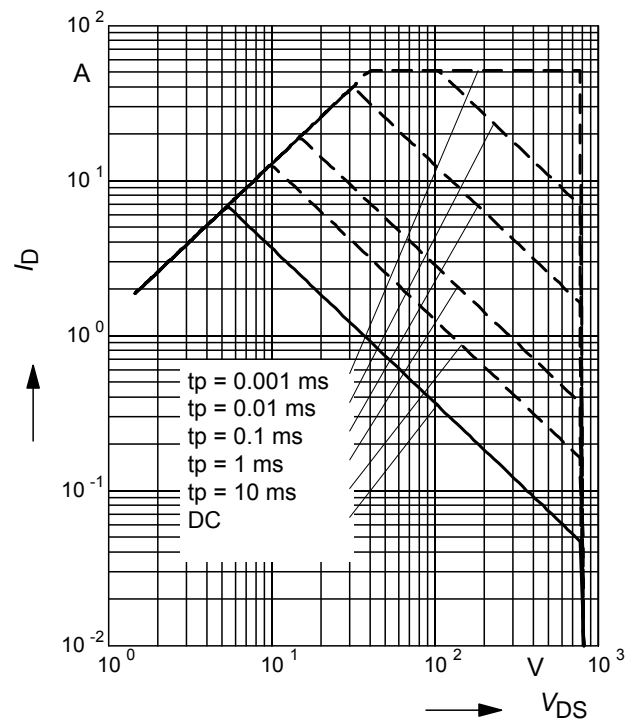

### 5 Transient thermal impedance

$$Z_{thJC} = f(t_p)$$

parameter:  $D = t_p/T$

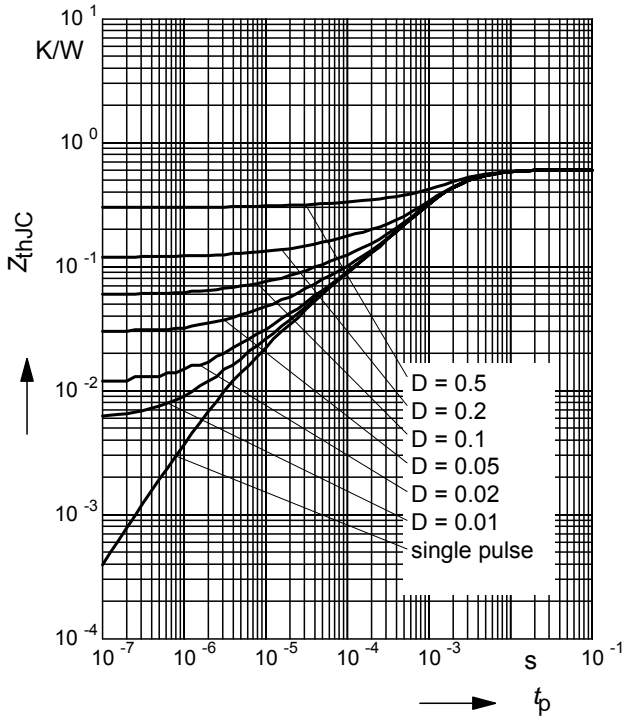

### 6 Transient thermal impedance FullPAK

$$Z_{thJC} = f(t_p)$$

parameter:  $D = t_p/t$

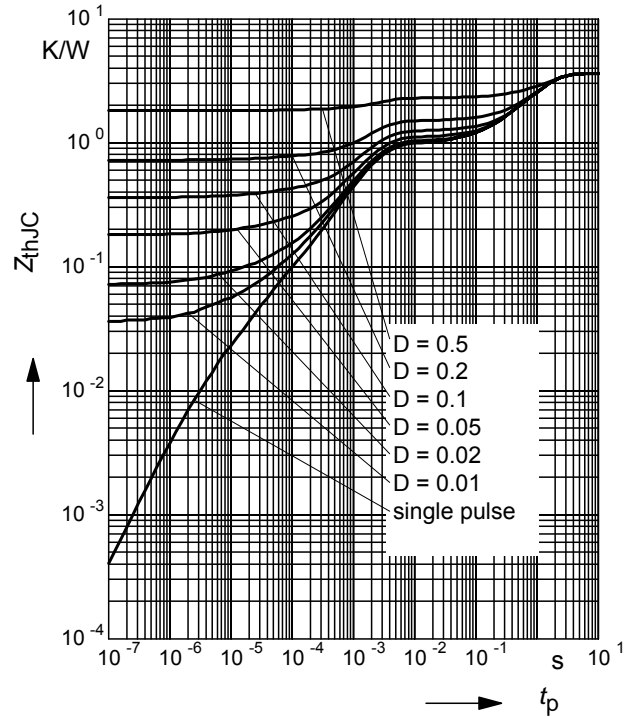

### 7 Typ. output characteristic

$$I_D = f(V_{DS}); T_j = 25^\circ\text{C}$$

parameter:  $t_p = 10 \mu\text{s}, V_{GS}$

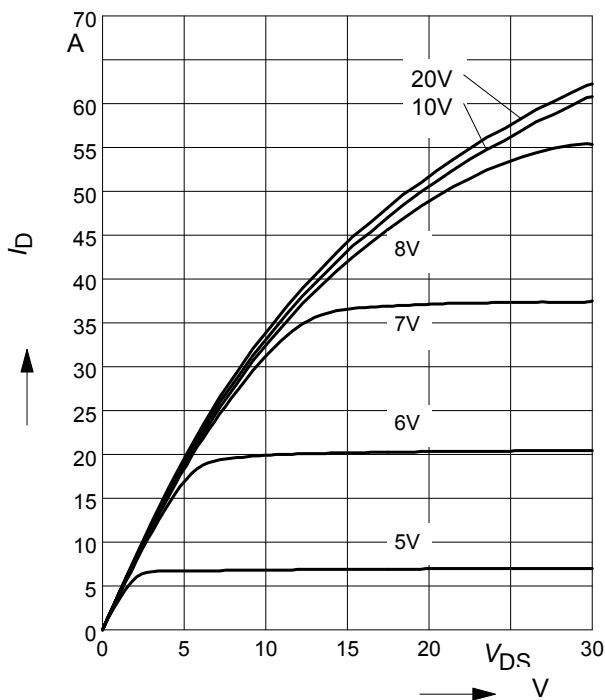

### 8 Typ. output characteristic

$$I_D = f(V_{DS}); T_j = 150^\circ\text{C}$$

parameter:  $t_p = 10 \mu\text{s}, V_{GS}$

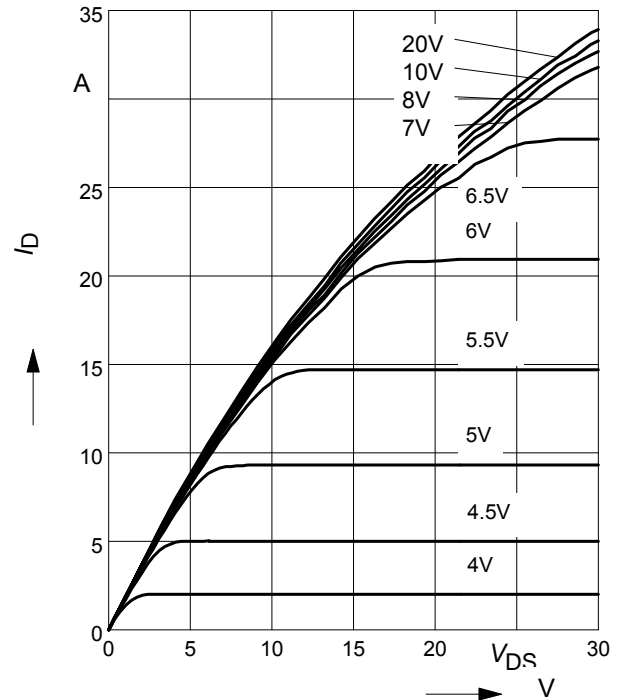

### 9 Typ. drain-source on resistance

$$R_{DS(on)} = f(I_D)$$

parameter:  $T_j = 150^\circ\text{C}$ ,  $V_{GS}$

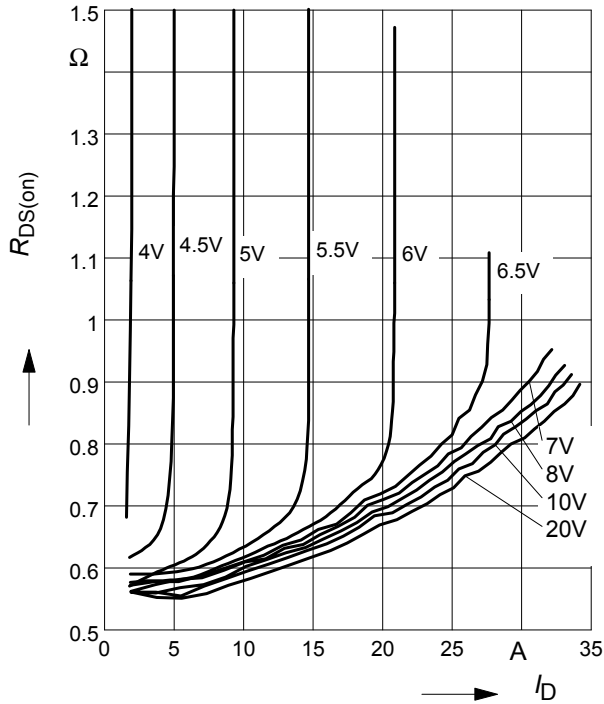

### 10 Drain-source on-state resistance

$$R_{DS(on)} = f(T_j)$$

parameter:  $I_D = 11\text{ A}$ ,  $V_{GS} = 10\text{ V}$

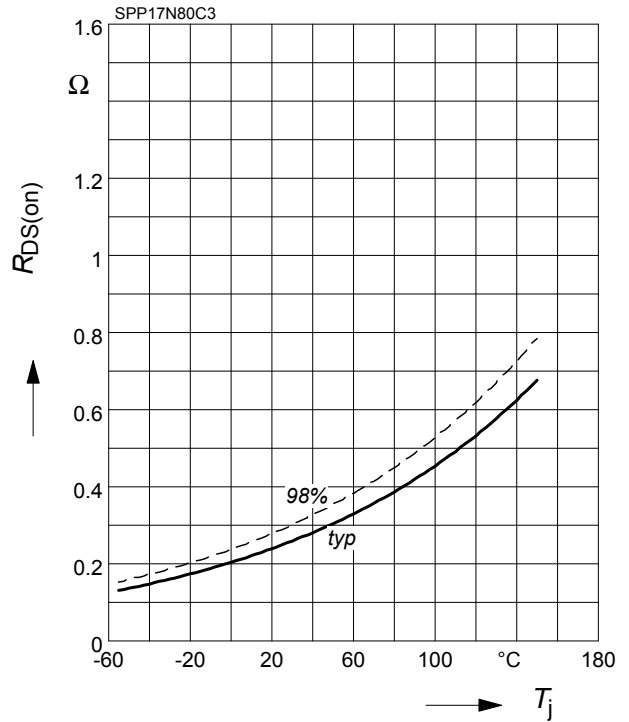

### 11 Typ. transfer characteristics

$$I_D = f(V_{GS}); V_{DS} \geq 2 \times I_D \times R_{DS(on)max}$$

parameter:  $t_p = 10\ \mu\text{s}$

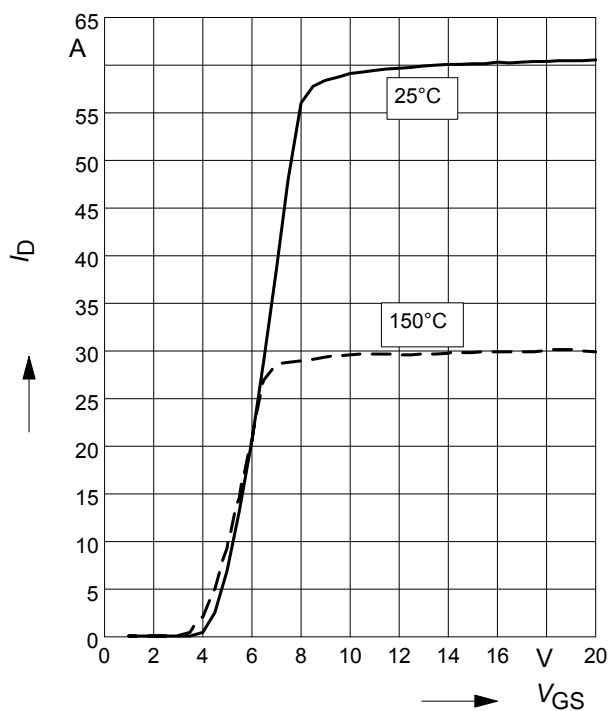

### 12 Typ. gate charge

$$V_{GS} = f(Q_{Gate})$$

parameter:  $I_D = 17\text{ A pulsed}$

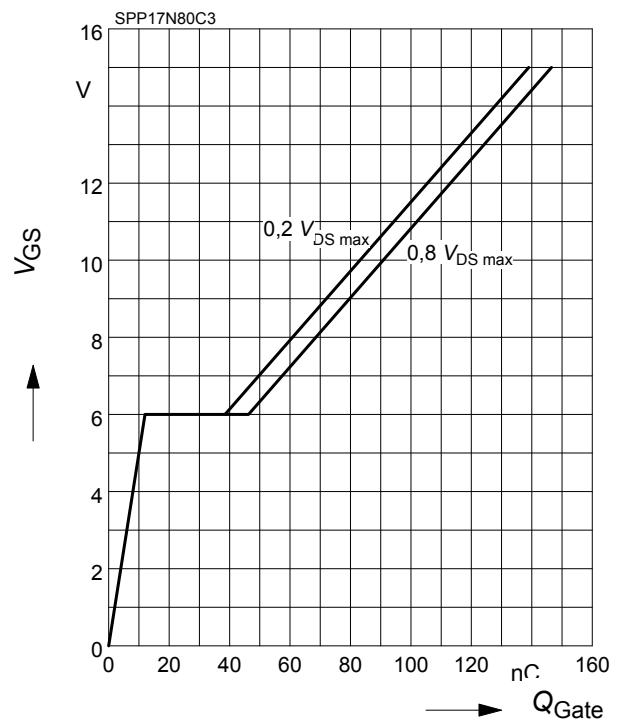

### 13 Forward characteristics of body diode

$$I_F = f(V_{SD})$$

parameter:  $T_j$ ,  $t_p = 10 \mu s$

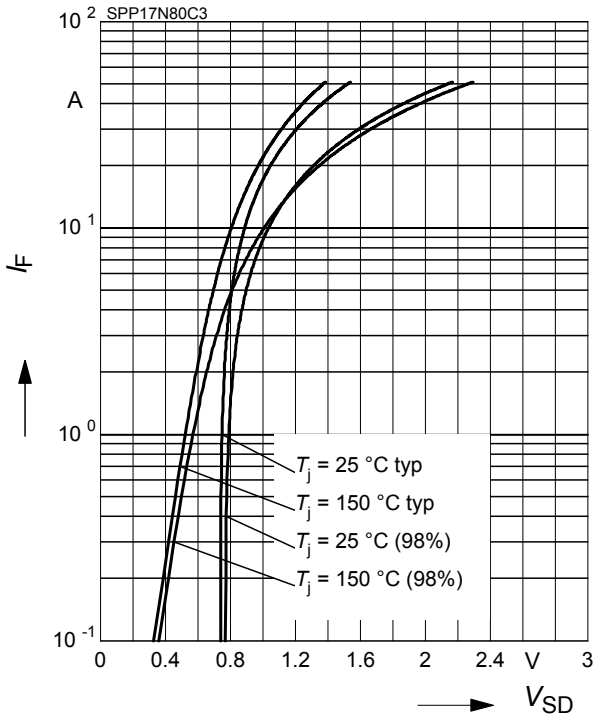

### 14 Avalanche SOA

$$I_{AR} = f(t_{AR})$$

par.:  $T_j \leq 150 \text{ °C}$

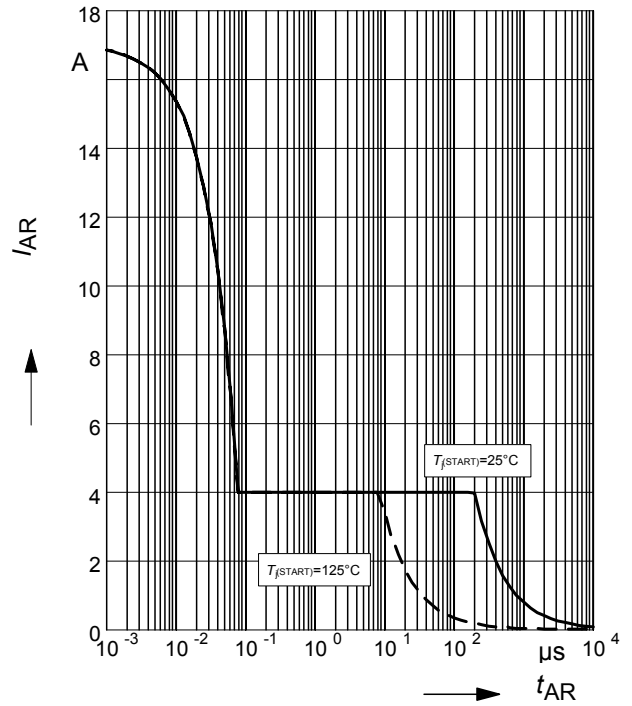

### 15 Avalanche energy

$$E_{AS} = f(T_j)$$

par.:  $I_D = 3.4 \text{ A}$ ,  $V_{DD} = 50 \text{ V}$

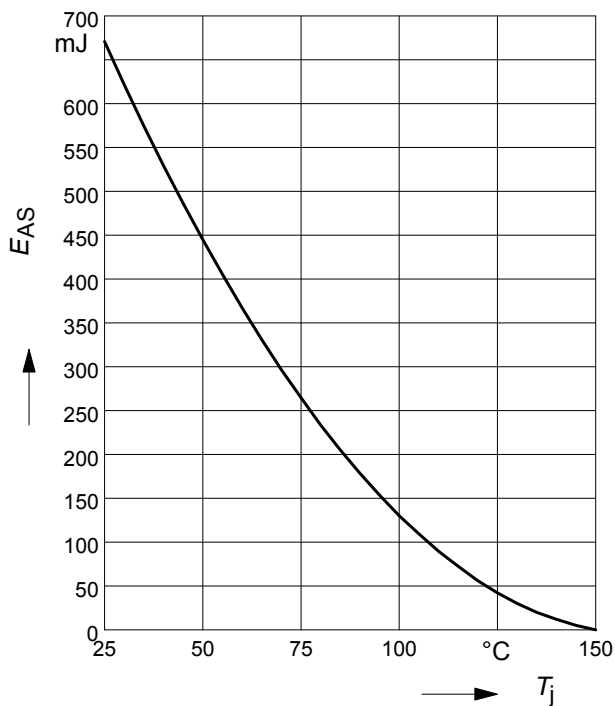

### 16 Drain-source breakdown voltage

$$V_{(BR)DSS} = f(T_j)$$

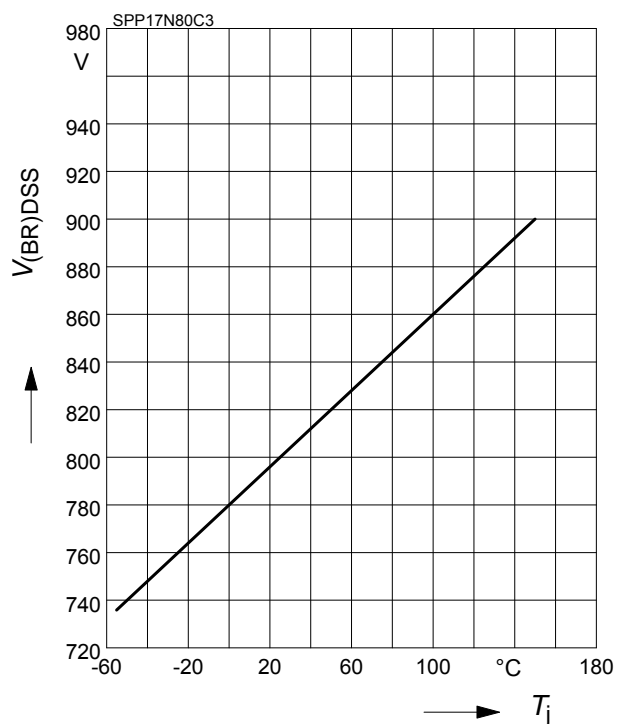



### 17 Avalanche power losses

$$P_{AR} = f(f)$$

parameter:  $E_{AR}=0.5\text{mJ}$

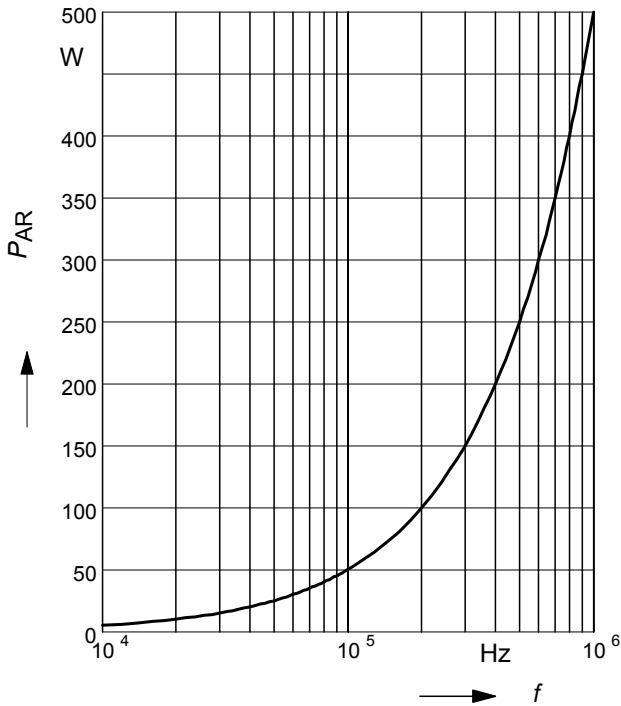

### 18 Typ. capacitances

$$C = f(V_{DS})$$

parameter:  $V_{GS}=0\text{V}$ ,  $f=1\text{ MHz}$

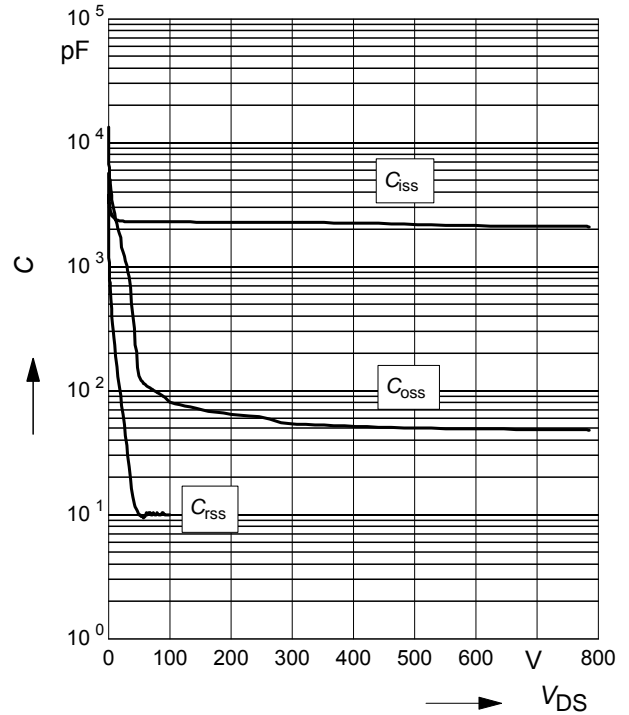

### 19 Typ. $C_{oss}$ stored energy

$$E_{oss} = f(V_{DS})$$

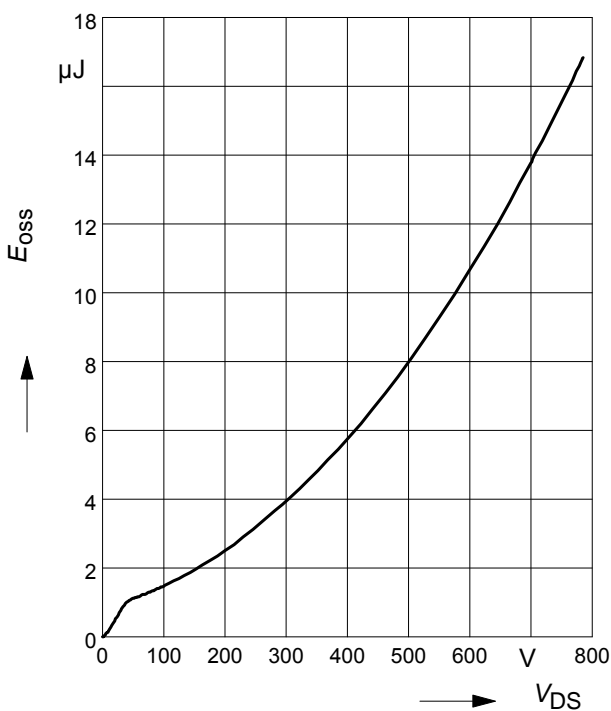

Definition of diodes switching characteristics

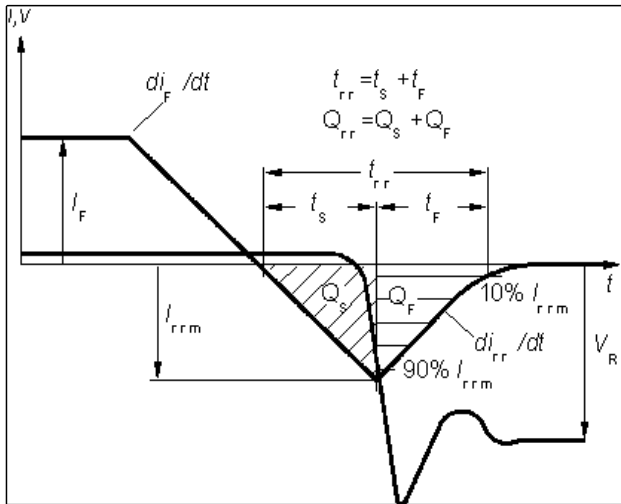

PG-TO220-3-1, PG-TO220-3-21

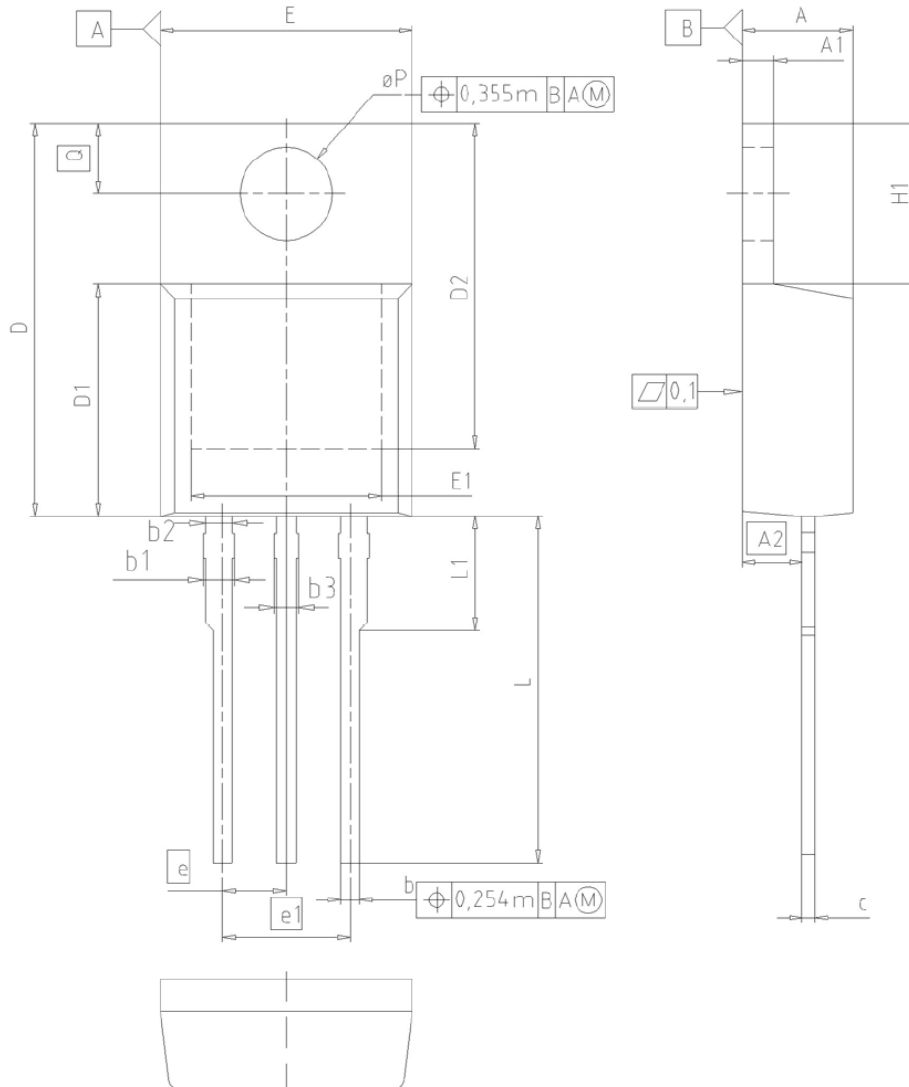

DIM	MILLIMETERS		INCHES	
	MIN	MAX	MIN	MAX
A	4.30	4.57	0.169	0.180
A1	1.17	1.40	0.046	0.055
A2	2.15	2.72	0.085	0.107
b	0.65	0.86	0.026	0.034
b1	0.95	1.40	0.037	0.055
b2	0.95	1.15	0.037	0.045
b3	0.65	1.15	0.026	0.045
c	0.33	0.60	0.013	0.024
D	14.81	15.95	0.583	0.628
D1	8.51	9.45	0.335	0.372
D2	12.19	13.10	0.480	0.516
E	9.70	10.36	0.382	0.408
E1	6.50	8.60	0.256	0.339
e	2.54		0.100	
e1	5.08		0.200	
N	3		3	
H1	5.90	6.90	0.232	0.272
L	13.00	14.00	0.512	0.551
L1	-	4.80	-	0.189
øP	3.60	3.89	0.142	0.153
Q	2.60	3.00	0.102	0.118

DOCUMENT NO.  
Z8B00003318

SCALE

EUROPEAN PROJECTION

ISSUE DATE  
23-08-2007

REVISION  
05

PG-TO220-3-31 (FullPAK)

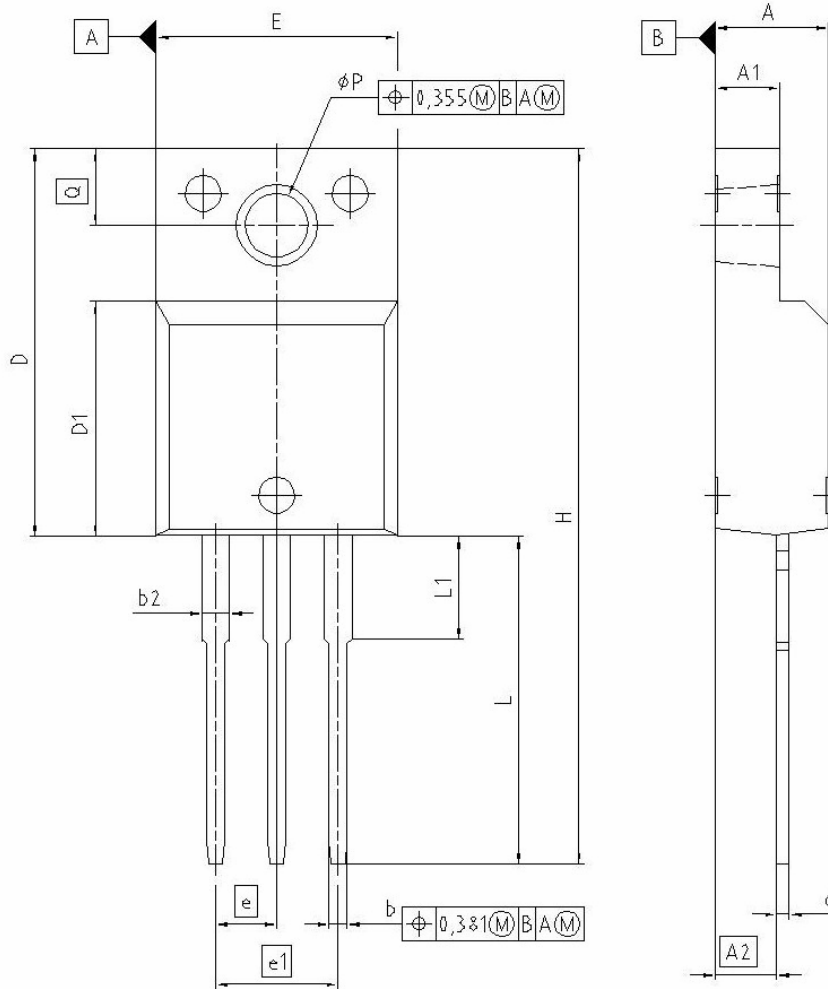

DIM	MILLIMETERS		INCHES	
	MIN	MAX	MIN	MAX
A	4.572	4.826	0.180	0.190
A1	2.573	2.827	0.101	0.111
A2	2.514	2.616	0.099	0.103
b	0.649	0.776	0.025	0.030
b2	1.143	1.509	0.045	0.059
c	0.449	0.627	0.017	0.027
D	15.863	16.117	0.624	0.634
D1	9.554	9.808	0.376	0.386
E	10.373	10.627	0.408	0.418
e	2.540		0.100	
e1	5.080		0.200	
N	3		3	
H	29.463	29.717	1.160	1.170
L	13.473	13.727	0.530	0.540
L1	3.175	3.429	0.125	0.135
phi P	2.949	3.025	0.119	0.116
Q	3.149	3.251	0.124	0.128

**REFERENCE**  
J..

**SCALE**

**EUROPEAN PROJECTION**

**ISSUE DATE**  
17-08-2005

**FILE**  
TO220\_2

**Published by**  
**Infineon Technologies AG**  
**81726 Munich, Germany**  
**© 2007 Infineon Technologies AG**  
**All Rights Reserved.**

**Legal Disclaimer**

The information given in this document shall in no event be regarded as a guarantee of conditions or characteristics. With respect to any examples or hints given herein, any typical values stated herein and/or any information regarding the application of the device, Infineon Technologies hereby disclaims any and all warranties and liabilities of any kind, including without limitation, warranties of non-infringement of intellectual property rights of any third party.

**Information**

For further information on technology, delivery terms and conditions and prices, please contact the nearest Infineon Technologies Office ([www.infineon.com](http://www.infineon.com)).

**Warnings**

Due to technical requirements, components may contain dangerous substances. For information on the types in question, please contact the nearest Infineon Technologies Office. Infineon Technologies components may be used in life-support devices or systems only with the express written approval of Infineon Technologies, if a failure of such components can reasonably be expected to cause the failure of that life-support device or system or to affect the safety or effectiveness of that device or system. Life support devices or systems are intended to be implanted in the human body or to support and/or maintain and sustain and/or protect human life. If they fail, it is reasonable to assume that the health of the user or other persons may be endangered.