

## General Information

1994

Covers Models:

DTX-14A1/14B1/20A1/  
21A1/21C1

UK: T140/T142

T200/T202/T512

CRT: 9 options in 14"/20"/21"

A34JLL90X/A34EAC01X06/  
A33EFU13X01/A48JLL90X/  
A48ECR11X16/A48EEV33X01/  
A51JSW90X/A51EAL55X01/  
A51EER11X40

Remote Control:

R-22 or R23 - Text

R-25 or R-26 - Non Text

Main Power Button:

4854837402 - 21C1

4854838201 - 21A1

4854838101 - 20A1

4854837101 - 14B1

4854838001 - 14A1

## Specifications

Main Voltage	230V AC 50Hz
Power Consumption	69W approx. (14") 85W approx. (20" + 21")
Sound Output	2.0W approx. (at 60% MOD, 10% THD)
Antenna Impedance	75 ohm unbalanced
Tuning System	Voltage Synthesis Tuning System
Number of Program	100
Reception channel	Refer to Tuner description
Remote Control	With TEXT: R-22 or R-23 Without TEXT: R-25 or R-26
Screen Size (Diagonal)	14": 340mm 20": 480mm 21": 510mm
Indication	On-Screen display - Program No. (00 - 99) - Sleep (15 - 120) - Mute - AV - Normal (Normal I, Normal II, Favourite) Main Menu (Contrast, Brightness, Colour, Sharpness, Tint (NTSC option)) - Time Menu (Clock, On/Off Timer) - Preset Menu (FAS, Auto Search, Fine Tuning)

## Service

### Adjustments

#### Safety Instructions.

#### X-Ray Radiation Precaution

- Excessive high voltage can produce

potentially hazardous X-Ray Radiation. To avoid such hazards, the high voltage must not exceed the specified limit. The nominal value of the high voltage of this receiver is 25.5kv (14": 23.5kv, 21": 26.5kv) at max beam current. The high voltage must not, under any circumstances, exceed 27.5kv (14": 25.0kv, 21": 29.0kv). Each time a receiver needs servicing, the high voltage should be checked following the HIGH VOLTAGE CHECK. It is recommended the reading of the high voltage be recorded as part of the service records. It is important to use an accurate and reliable high voltage meter.

- The only source of X-RAY RADIATION in this TV receiver is the picture tube. For continued X-RAY RADIATION protection, the replacement tube must be exactly the same type tube as recommended in the parts list.

### Installation and Service Adjustments

#### High Voltage Check

- Connect an accurate high voltage meter to the anode of the picture tube.
- Turn on the receiver. Set the BRIGHTNESS and CONTRAST controls to minimise (zero beam current).
- High voltage should be below 27.5kv (14": 25.0kv, 21": 29.0kv).

#### Dynamic Convergence Adjustment

Dynamic convergence (convergence of the three colour field at the edges of the CRT screen) is accomplished by proper insertion and positioning of three rubber wedges between the edges of the deflection yoke and the funnel of the CRT. This is accomplished as follows:

- Switch the receiver on, allow it to warm up for 15 minutes.
- Apply crosshatch pattern from dot/bar generator to the receiver. Observe spacing between lines around edges of the CRT screen.
- Tilt the deflection yoke up and down, and insert tilt adjustment wedges 1 and 2 between the deflection yoke and CRT until the mis-convergence illustrated in fig. 2 (A) has been corrected.
- Tilt the deflection yoke right and left, and insert tilt adjustment wedge 3 between the deflection yoke and CRT until mis-convergence illustrated in fig. 2 (B) has been corrected.
- Alternately change spacing between, and depth of the insertion of, the three wedges until proper dynamic convergence is obtained.
- Use a strong adhesive tape to firmly secure latch of the three rubber wedges to the funnel of the CRT.
- Check purity and readjust, if necessary.

#### Static (centre) Convergence Adjustment

- Switch the receiver on and allow to warm up for 15 minutes.
- Connect the output of a crosshatch generator to the receiver and concentrating on the centre of the CRT

- screen, proceed as follows:
- Locate the pair of 4 pole magnet rings. Rotate individual rings (change spacing between tabs) to converge the vertical red and blue lines. Rotate the pair of rings (maintaining space between tabs) to converge the horizontal red and blue lines. (Refer to fig. 1(A)).
- After completing red and blue centre convergence, locate the pair of 6 pole magnet rings. Rotate individual rings (change spacing between tabs) to converge the vertical red and blue (Magenta) and green lines. Rotate the pair of rings (maintaining spacing between tabs) to converge the horizontal red and blue (Magenta) and green lines. (Refer to fig. 1(B)).

#### Colour Purity Adjustment

For the best result, it is recommended that the purity adjustment is made in final receiver location. If the receiver will be moved, perform adjustment with it facing east. The receiver must have been operating 15 minutes prior to this procedure and the faceplate of the CRT must be at room temperature. The receiver is equipped with an automatic degaussing circuit. But, if the CRT shadow mask has come excessively magnetised, it may be necessary to degauss it with manual coil. Do not switch the coil. The following procedure is recommended while using a dot generation.

- Check for correct location of all neck components (see fig. 5).
- Rough-in the static convergence at the centre of the CRT, as explained in the static convergence procedure.
- Rotate the picture control to centre of its rotation range, and rotate brightness control to max. CW position.
- Apply green colour signal to procedure a green raster.
- Loosen the deflection yoke tilt adjustment wedges (3), loosen the deflection yoke clamp screw and push the deflection yoke as close as possible to the CRT screen.
- Begin the following adjustment with the tabs on the round purity magnet rings set together. Initially move the tabs on the round purity magnet rings to the side of the CRT neck. Then, slowly separate the two tabs while at the same time rotating them to adjust for a uniform green vertical band at the CRT screen.
- Carefully slide the deflection yoke backward to achieve green purity (uniform green screen). Centre purity was obtained by adjusting the tabs on the round purity magnet rings, outer edge purity was obtained by sliding the deflection yoke forward.
- Tighten the deflection yoke clamp screw.
- Check for red and blue field purity by applying red signal and touch up adjustments, if required.
- Perform black and white tracking procedure.

#### Screen and White Balance Adjustment

- This adjustment is to be made only after warming up for at least 15 minutes.
- Receive B/W pattern signal.
- Set the RGB Bias VR (R522, R512, R502) to MINIMUM.
- Set the G, B Drive VR (R515, R505) to CENTRE.

- Set the CONTRAST, BRIGHTNESS and COLOUR control to MIN, and Sub-brightness control to CENTRE.
- Connect a short clip to P301.
- Rotate the SCREEN control to clockwise or CCW so as to obtain dim horizontal line of one colour in R, G or B.
- Rotate the R, G, and B Bias VR of the other colour which did not appear on the screen clockwise, until a dim white line is obtained.
- Rotate the Screen control gradually anti-clockwise until the last horizontal line disappears on the screen.
- Remove the short clip and set the CONTRAST, BRIGHTNESS, COLOUR control to MAX.
- Set the G, B Drive VR to obtain the best white uniformity on the screen.
- Rotate the CONTRAST, BRIGHTNESS, COLOUR controls until a dim raster is obtained and touch-up adjustment of RGB Bias VR to obtain the best white uniformity on the screen.

#### Sub-Brightness Adjustment.

- White balance adjustment must proceed this procedure.
- Set the CONTRAST, BRIGHTNESS, COLOUR controls to MIN.
- Rotate the SUB-BRIGHTNESS VR (VR701) gradually CCW until the last beam disappears on the screen.

#### Vertical Height Adjustment

- Receive RETMA pattern signal.
- Set the BRIGHTNESS and CONTRAST control to Max., and COLOUR control to the centre.
- Adjust VR301 for the optimum vertical height and over scanning.

#### Vertical Centre Adjustment

- Receive RETMA pattern signal.
- Adjust VR302 so that the vertical centre of the picture may be coincident with the mechanical centre of CRT.

#### Horizontal Centre Adjustment

- Receive RETMA pattern signal.
- Adjust VR401 so that the horizontal centre of the picture may be coincident with the mechanical centre of CRT.

#### Focus Voltage Adjustment

- Receive RETMA pattern signal.
- Adjust the FOCUS VOLUME on the FBT and make the picture on the screen be finest.

#### RF AGC Adjustment

- Receive PAL COLOUR BAR signal in the VHF high band where the strength of signal can be 60 - 65 dB.
- Set the CONTRAST control to MAX., the BRIGHTNESS control to provide adequate black and grey scales.
- Maintain the fine tuning on the screen, and adjust VR101 (AGC DELAY CONTROL VR.) in order that it may be located on the position which the picture noise disappear on the image.

#### Main B<sup>+</sup> (+103v) Adjustment

- Receive RETMA pattern signal.
- Set the picture level to NORMAL I mode.

- Connect DC voltage meter to the TP6 and adjust VR801 for +103v DC.

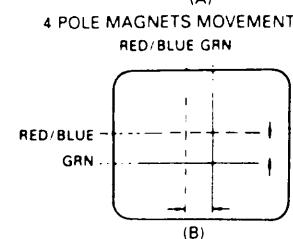
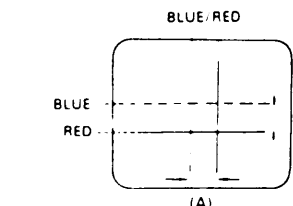

Fig 1.

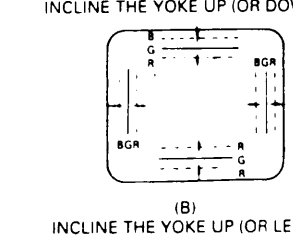
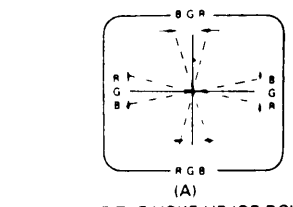

Fig 2.

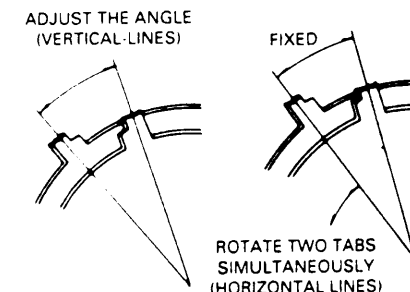

Fig 3.

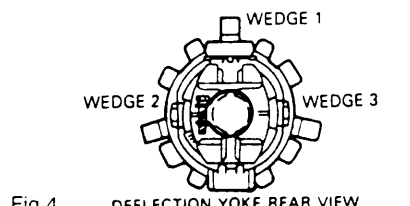

Fig 4.

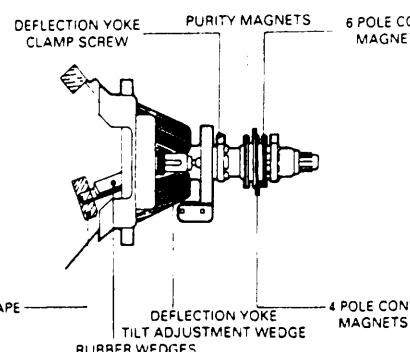

Fig 5.

### PIF Adjustment

#### Apparatus Connection and Presetting

##### 1: Connection:

- Connect H-out of LSW-480 to X-axis of the oscilloscope and V-out of LSW-480 to Y-axis of the oscilloscope.
- Connect the sweep signal output to TP1.
- Set ATTENUATOR of LSW-480 to 30dB.
- Supply 15v D.C. voltage (B+) to TP4.
- Supply 4-5v D.C. voltage to TP3.
- Connect wire lead between cathode of D401 and I402 #3.

##### Preset:

- Oscilloscope Scaling:

- Put the scale of X and Y of the oscilloscope to D.C. level.
- Set the horizontal time display to X-Y.
- Put horizontal axis (X) to 1V/div. and the vertical axis (Y) to 2V/div.

##### 2: LSW-480 MARKER FREQ. SETTING

	$f_p(n+1)$	$f_s$	$f_c$	$f_{p-2}$	$f_p$	$f_s(n-1)$
B/G, D/K, L	31.9	33.4	34.5	36.9	38.9	40.4
I	31.9	33.5	35.07	37.5	39.5	41

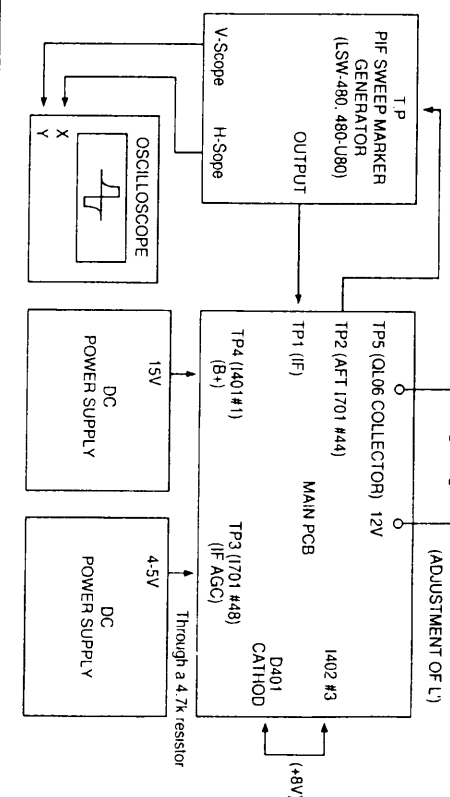

Fig 6. - Connection for PIF Adjustment

##### 2: Adjustment of AFT(B/G, D/K, I, L)

- Connect the test point of LSW-480 to TP2.
- Adjust L103(AFT COIL) so that the P marker point is located on the reference level.

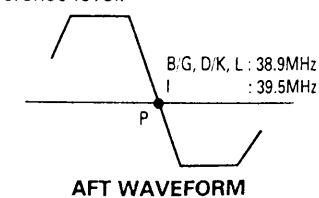

Fig 7.

## Service Adjustments Cont'd.

### 3: Adjustment of SECAM-L' AFT

- 1: Connect TP5 (QL06 collector) to +12V.
- 2: Adjust CL09 (L'AFT TRIMMER) so that the C marker point (34.47mhz) is located on the reference level.

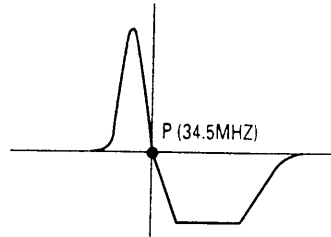
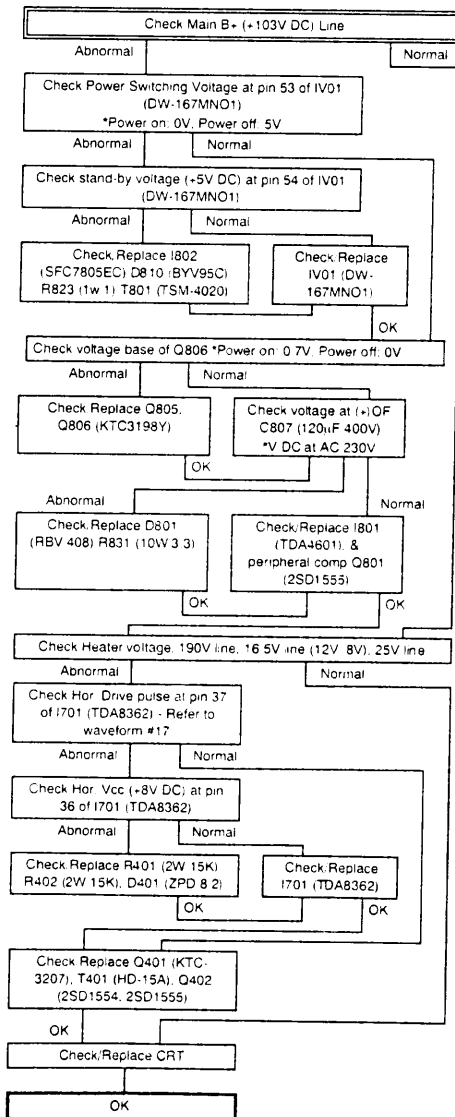

Fig 8. L' AFT WAVEFORM

## Trouble Shooting Guides

### No Raster



### No Picture (Raster OK)

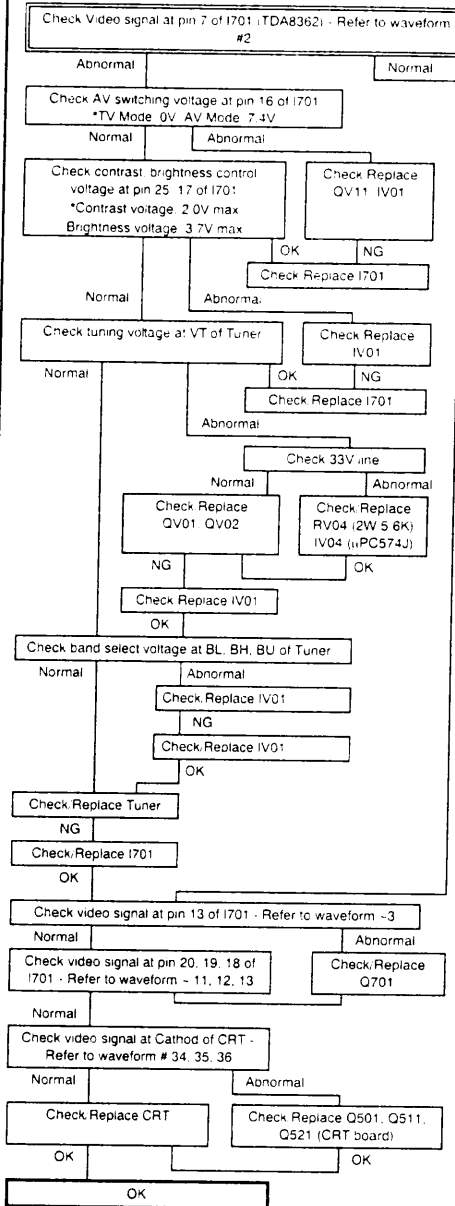

### Auto Search Trouble (Channel Skip)

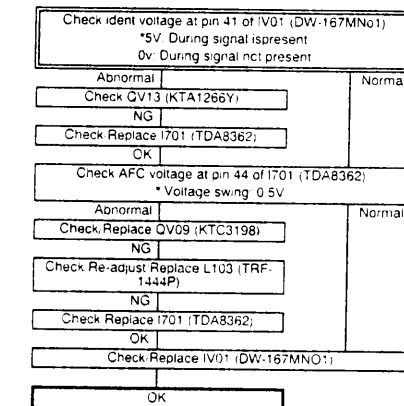

### No Vertical Scanning (One horizontal line on screen)

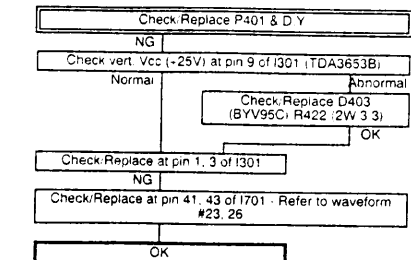

### No Colour

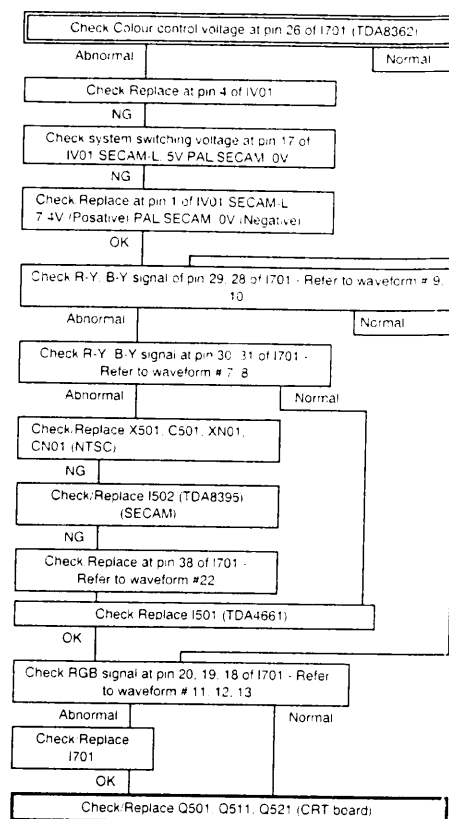

### No Sound (Picture OK)

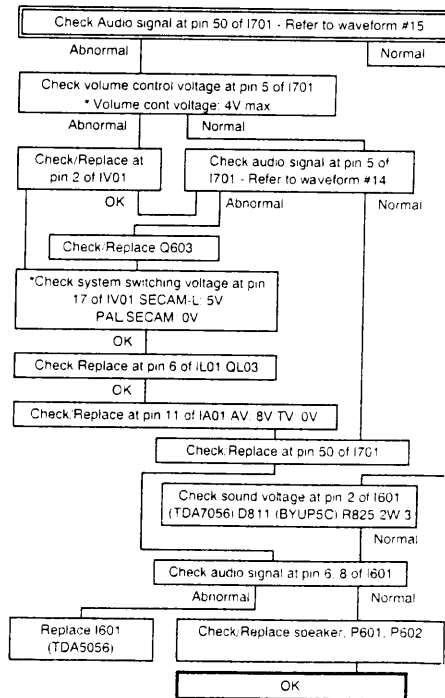

### No External AV

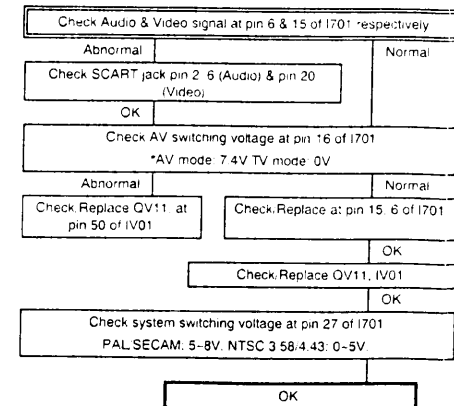

### No OSD

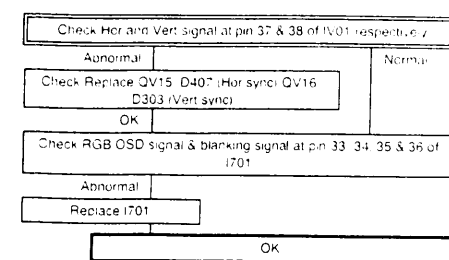

### Remote Control (Local Control On)

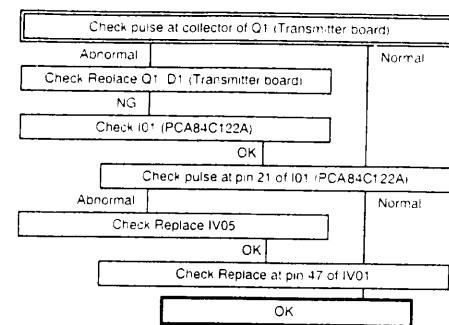

### No Teletext

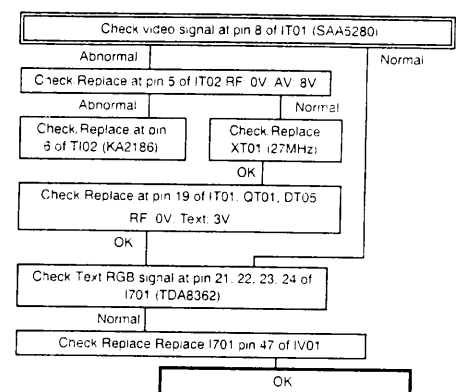

## Different Parts for Size

No.	Loc.	14"	Philips	Polkolor
1	CRT	Orion A34JLL90X	A34EAC01X06	A33EFU13X01
2	CRT Socket	ISM-01	-	CTV3240-0501
3	D/Coil	DC-1450	-	-
4	T402	DCF-2077D	FSA24008S	1142.5025B
5	L403	L-125	L-102	L-76
6	L405	AZ-9004Y	-	-
7	R308	2W 120	-	-
8	R411	1/2W 180K	-	-
9	R423	2W 56	-	-
10	R421	1W 5.6(F)	1W 3.9(F)	1W 0.68
11	R501	2W 9.1K	-	-
12	R511	2W 9.1K	-	-
13	R521	2W 9.1K	-	-
14	RV09	2.2K	-	-
15	RV17	11K	-	-
16	C409	1.6KV 6200	1.6KV 6200	1.6KV 6000
17	C410	2KV 220	2KV 680	2KV 220
18	C411	200V 0.47	-	200V 0.51
19	R801	ERP-Z5B5N 180A	-	-

No.	Loc.	20"	Samsung	Polkolor
1	CRT	Orion A48JLL90X	A48ECR11X16	A48EEV33X01
2	CRT Socket	ISM-03	CTV3240-0501	-
3	D/Coil	DC-2050	-	-
4	T402	DCF-2217J	FSA-17013M	FSA26012M
5	L403	L-102	L-62	L-76
6	L405	Jumper	-	-
7	R308	2W 270	-	-
8	R411	1/2W 120K	-	-
9	R423	Jumper	-	-
10	R421	1W 6.8(F)	2W 2.7(F)	2W 2.4(F)
11	R501	2W 12K	-	-
12	R511	2W 12K	-	-
13	R521	2W 12K	-	-
14	RV09	2.7K	-	-
15	RV17	4.7K	-	-
16	C409	1.6KV 7200	1.6KV 8200	1.6KV 8200
17	C410	2KV 1000	2KV 470	-
18	C411	200V 0.47	200V 0.51	200V 0.51
19	R801	-	-	-

No.	Loc.	21"	Philips	Samsung
1	CRT	Orion A51JSW90X	A51EAL55X01	A51EER11X40
2	CRT Socket	ISM-03	CTV3240-0501	-
3	D/Coil	DC-2070	-	-
4	T402	DCF-2217L	FSA-17013M	-
5	L403	L-102	L-62	L-102
6	L405	-	-	-
7	R308	2W 180	-	-
8	R411	-	-	-
9	R423	-	-	-
10	R421	1W 6.8(F)	-	-
11	R501	-	-	-
12	R511	-	-	-
13	R521	-	-	-
14	RV09	-	-	-
15	RV17	-	-	-
16	C409	1.6KV 8200	1.6KV 78500	-
17	C410	-	2KV 470	-
18	C411	200V 0.33	200V 0.47	-
19	R801	DTH451C2628F14 0M270	-	-

## Different Parts for SMPS (Option)

No	Loc.	230V 50Hz	110-260V 50/60HZ
1	T801	TSM-4020	-
2	C807	150uF 400V	220uF 400V
3	DF03	-	BYV95C
4	RF05	-	5.1K
5	DF04	-	ZPD12
6	CF01	-	1M 160V
7	QF01	-	KTC3207
8	DF05	-	ZPD18
9	RF06	-	33K
10	R812	1/4W 15K	1/4W 13K
11	R814	1/4W 2.7K	-

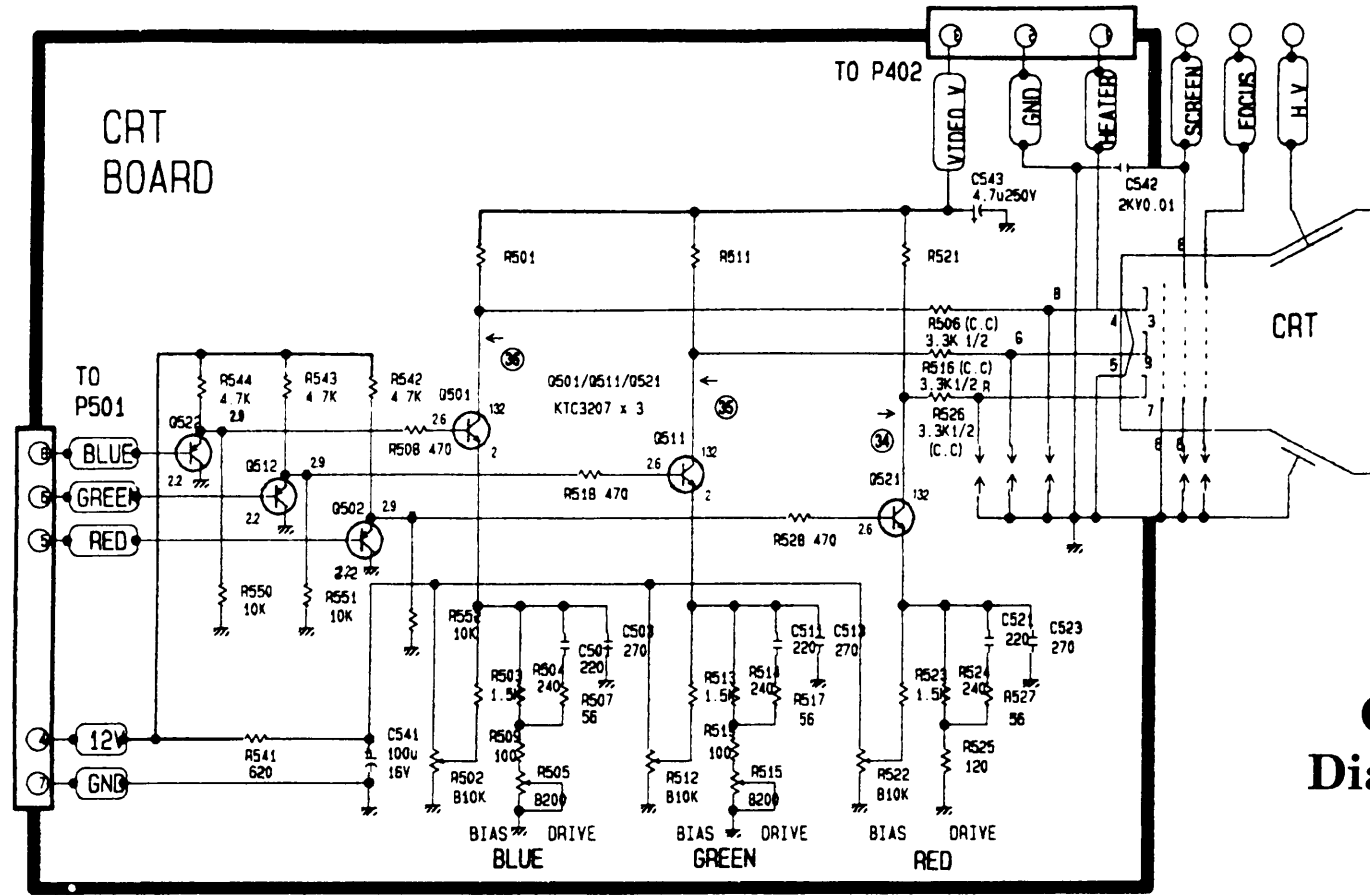

**CRT Diagram**

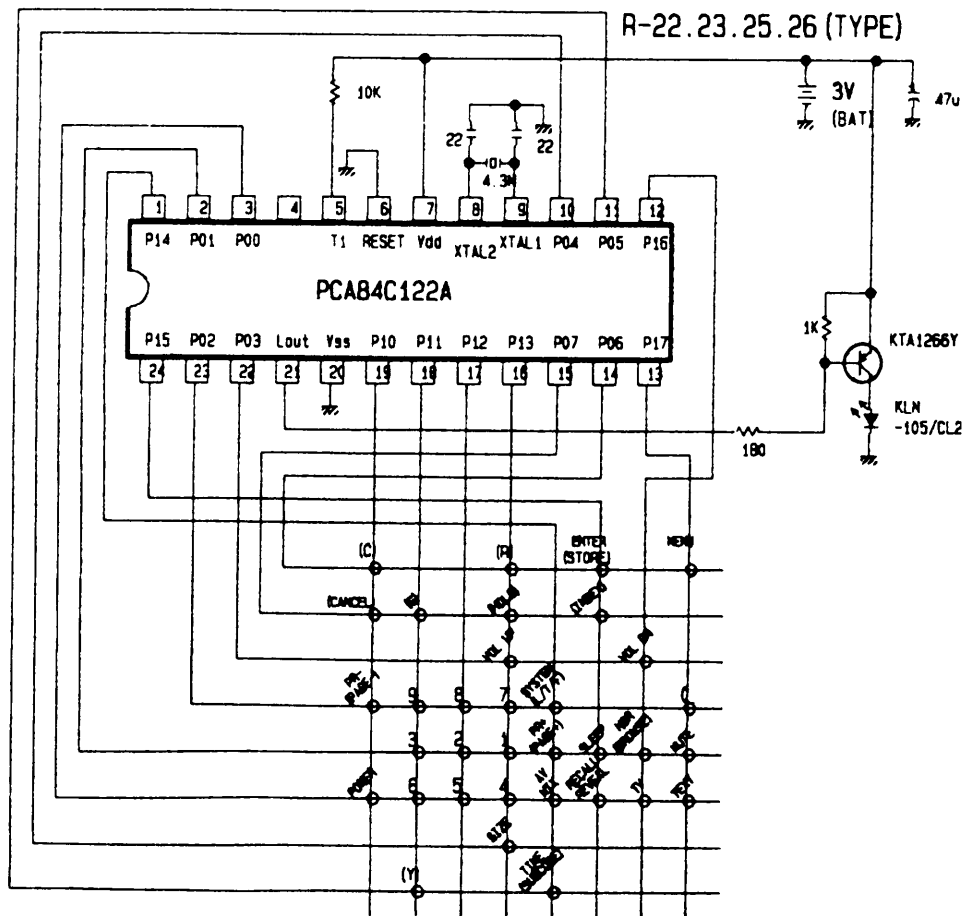

**Remote Control Diagram**

**Waveforms**

INPUT SIGNAL : PAL SYSTEM  
 VIDEO : 8 STEP COLOR BAR 87.5% AM  
 AUDIO : 1KHz SINE WAVE 60% FM

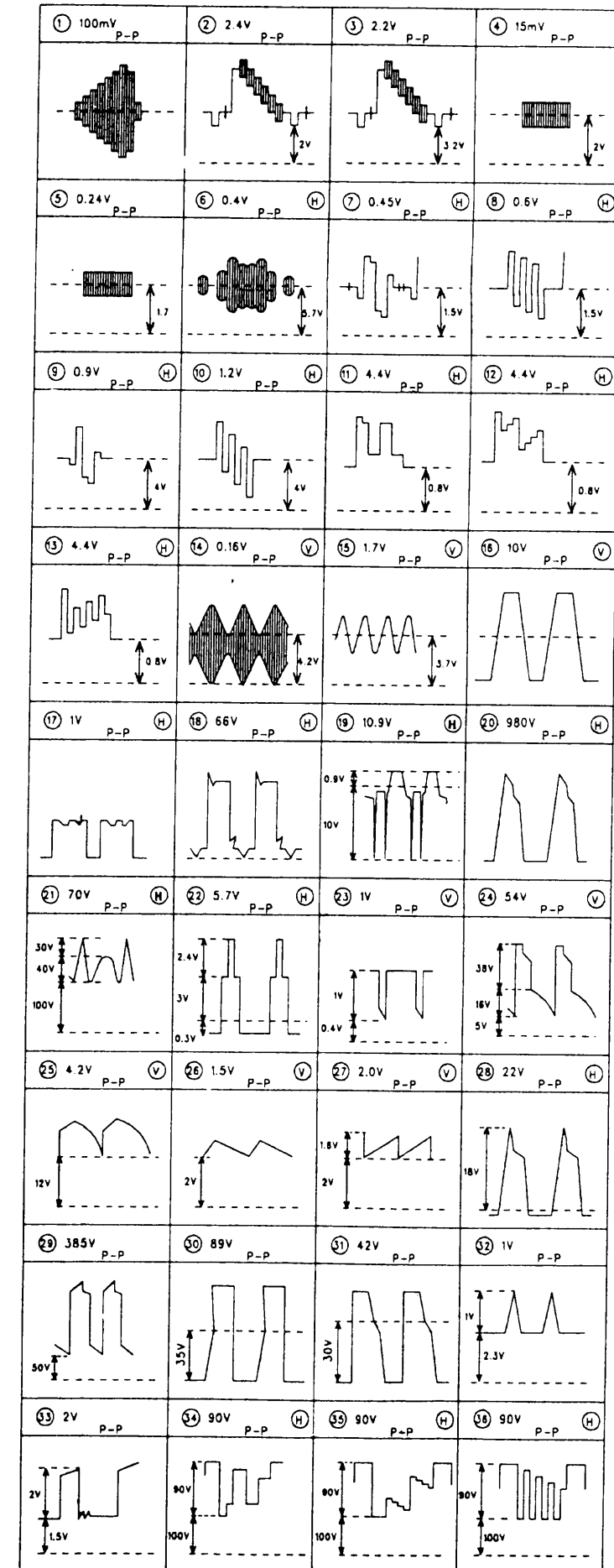

## Main Diagram

